



THE NINJAGO MOVIE

70620

LEVEL 1 THE OLD WORLD



LEGO.com/NINJAGOMOVIE

Booklet available in English on
Heft in deutscher Sprache erhältlich auf
Livret disponible en français sur
Libretto disponibile in italiano su
Folleto disponible en español en
Folheto disponível em português em
A füzet magyarul ezen a honlapon olvasható
如需中文版手册, 请访问 LEGO.com/NINJAGO

LEGO® NINJAGO® HISTORY

LEGO® NINJAGO® City is an ancient place, situated on the coast of NINJAGO Island. A sprawling metropolis, lack of real estate eventually led to the city being built vertically instead of spreading out horizontally. As a result, the city consists of layers constructed on top of each other. It is possible to trace the history of the city simply by working your way up from the lowest level. The city is broken up into three levels, known as the Old World, the Street and the High-rise.

The city truly has something for everyone. Restaurants and shops of every sort can be found somewhere in the metropolis. People from all over the island aspire to live and work in NINJAGO City, and the mix of residents brings a wonderful combination of cultures to the place. From the lowest level to the top of the top, NINJAGO City is a colorful and constantly entertaining place to live or visit.

Although the neighborhoods of NINJAGO City are very different from each other, people move freely between them to buy goods and do business. And, of course, the ninja team is always around to protect the citizens from evil.

What new adventures are waiting in NINJAGO City? You can make up your own stories or recreate what you see in THE LEGO NINJAGO MOVIE™. You decide!



MOVIE DIRECTOR INTERVIEW



Q: What was your vision of LEGO® NINJAGO® City going into the movie?

A: One of my first ideas about THE LEGO® NINJAGO® MOVIE™ from a stylistic point of view was to bring the toys outside into a natural environment, as if we are playing with LEGO bricks in the back yard. Along with the plants and other organic elements, I knew I wanted to have a lot of water. I thought about coastal cities in Asia and Europe that are designed around canals, and this felt like a great place to start. The other idea is that this is a city that is constantly rebuilding itself because of the continual attacks from Garmadon, so it felt really fun to think about a city building and re-building on top of itself.

Q: LEGO® NINJAGO® City is already familiar to fans from the animated TV show. How is the movie version different?

A: Aside from the scope and scale of it, it is not much different.

Q: How well do you think the LEGO® NINJAGO® City set captured the spirit of the setting in the film?

A: It is amazing. I know I am biased, but I think this is one of the coolest LEGO® sets ever – it has captured the spirit beautifully. In fact, there are some very specific things in the set that are actually in the movie. Can you find them?

Q: Sometimes a setting can be a character in its own right in a film. Do you think that is the case with LEGO® NINJAGO® City in your movie?

A: Absolutely. The design reflects the personality and variety of culture of the people of NINJAGO® City. There is a whimsy to the architecture that represents their good nature and positivity in the face of constant attacks from Garmadon. The people of NINJAGO City love their home and will not let it be destroyed by Garmadon.

Q: Do you have a favorite character or function in the LEGO® NINJAGO® City set?

A: It is funny, but I really love the ATM cash machine. It spits out money!

Q: The layers of the model show a city that has been built upon itself over the years. How central is this concept to the vision of the city in the film? Were there any real-life examples referenced as this idea was being developed?

A: As the film progressed, we developed a lot of backstory as to how the city was built. The concept is that the ancient feudal NINJAGO® town grew into the major metropolis it is today as the people built and rebuilt the city vertically upon the structures of the original village. We loved this idea, not only because it feels very much in LEGO® style, but also because it reflects how the present day NINJAGO City is rooted in its history. We looked at many real-world examples like Singapore, Hong Kong, Seattle, Sydney, New York and even Venice, London and Amsterdam.

- Charlie Bean, from the Directing Team of THE LEGO® NINJAGO® MOVIE™



LEGO® NINJAGO® LANGUAGE TRANSLATOR



X U 介 反 甘

A B C D E

7 母 白 火 才

F G H I J

水 本 巾 尸 回

K L M N O

平 田 入 尺 三

P Q R S T

山 事 人 一

U V W X

市 二

Y Z

\ 井 今 女 不

1 2 3 4 5

三 人 世 又 口

6 7 8 9 0

LEGO® NINJAGO® LANGUAGE CHALLENGE:

Use the key above to translate the signage hidden throughout the three levels of the city!

THE LEGO® NINJAGO® MOVIE™ IMAGES

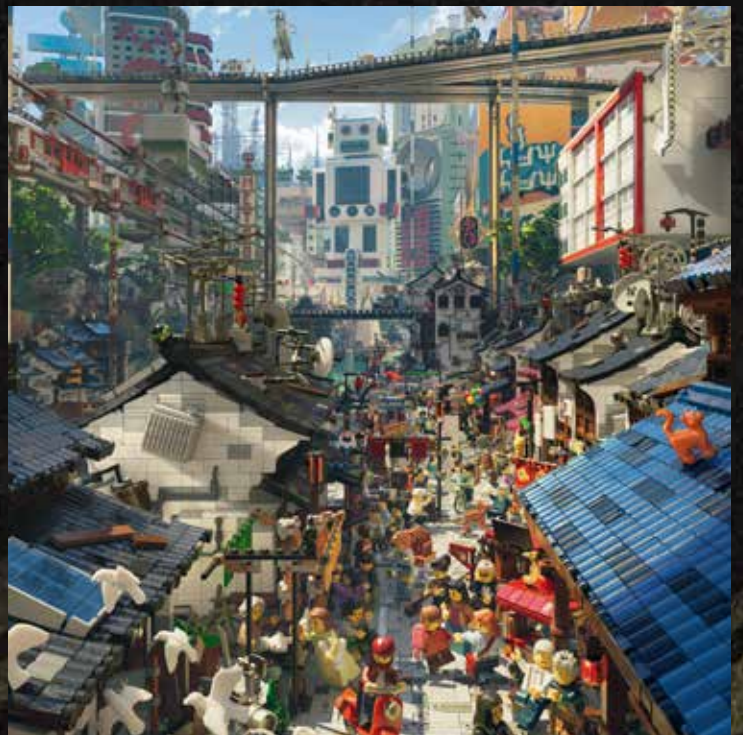

MODEL DESIGNER INTERVIEW



Q: What are some of the challenges of turning a movie location into a model?

A: In the movie, LEGO® NINJAGO® City is unlike anything we have seen before in a LEGO set. One of the main challenges with a model like this is the difference in size between the vast on-screen location and the smaller model version.

As both are built from LEGO bricks, our approach was to choose key silhouettes and details which could be rebuilt at a smaller scale and still match the overall look.

In order to capture the scope of NINJAGO City, we split the model into three sections, each representing a different chapter of the city's evolution. However, this led to the challenge of blending the levels together into a complete model. For example, we positioned the tower further back on the model, to give the impression of it rising from behind the buildings.

Q: What is your favorite functionality in the model?

A: Nico: Definitely the crab cooking function. After going through multiple iterations, some of which involved ejecting the uncooked crab back into the water, we ended up with a simple but very robust function that can transform almost anything that can fit inside the grill!

Chris: For me I would have to pick the sushi bar, as it is very simple and easily decodable for what it is meant to represent.

Q: The architectural style of LEGO® NINJAGO® City is layers built upon layers as time goes on. Did you do any research on similar structures in the real world while preparing to create this model?

A: We shared a lot of the same inspiration that the moviemakers used, but we also drew inspiration from real-life places we have visited, amazing cyberpunk creations in the fan community, and of course the NINJAGO® TV show.

Q: What was the most fun part of designing such a big and complex model?

A: Nico: My favorite part of designing this model was the opportunity to include things which we would not normally have in a NINJAGO® set, such as the pufferfish or the pink bonsai tree.

Chris: I found the most fun aspect of this model was how easy the size allowed me to visualize the characters' movements and interactions around the city.

Q: What other lines have you designed models for?

A: Nico: Up until now I have worked primarily for NINJAGO®, but have also helped out in small amounts on the MIXELS™ and BIONICLE® themes.

Chris: Having worked at the LEGO® Group for the past five years I have been lucky to work on Galaxy Squad, THE LEGO MOVIE™, Ultra Agents, Speed Champions and of course NINJAGO®.

Q: Do you have a favorite ninja?

A: Nico: Cole.

Chris: It has to be Zane because he is a robot and a ninja. I think everyone can agree that he is cool.

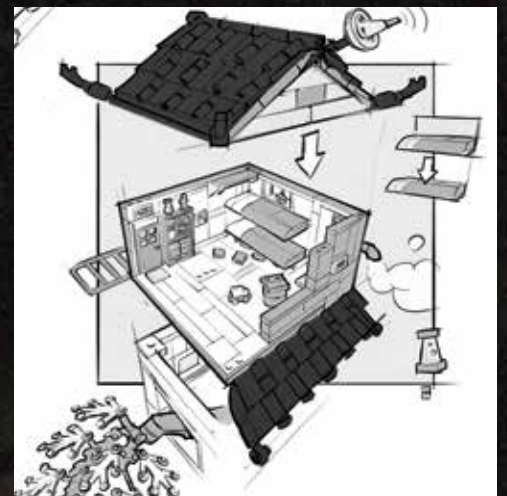
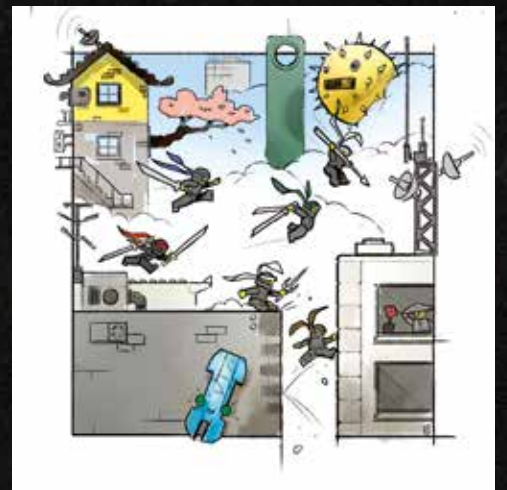
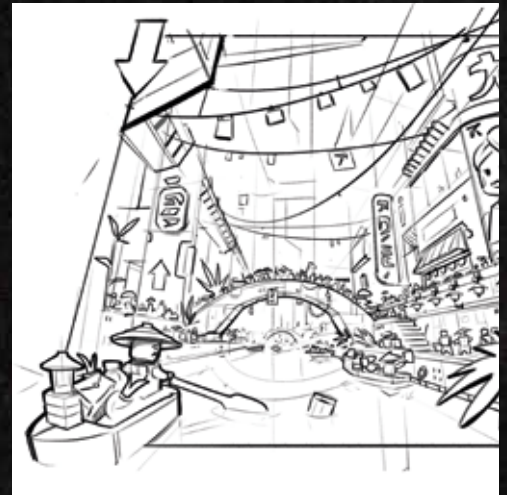

LEVEL 1 – THE OLD WORLD



The “ground floor” of the city is the oldest occupied section (it is possible that there are still older layers belowground). Here you can find evidence of the thriving fishing industry, including a well-known fish market and some excellent little seafood restaurants. It is also a great place to shop for bargains.

The lower level is great for walking around and seeing the sights. A stone pathway runs along the docks and leads to an ancient bridge. At any time of the day, visitors can see fishing boats leaving to go cast their nets in the coastal waters.

Residents live in small but comfortable homes here. Their “neighbors” include the base of the city’s elevator and the storage and repair facility for the maintenance robot.



MINIFIGURES



KAI

Kai's days off are packed with activities – ninja training, cooking, eating and trying to organize a Red Ninja fan club. Sometimes he has to be reminded to go to school!



JAMANAKAI VILLAGER

This aged man wanders around the lower level of the city, swapping frogs he has raised for trinkets. Very little of what he says makes any sense, but people listen anyway because they want the frogs.



SALLY

Smart and quick, she's great at swapping stuff for other things she needs. She drives a hard bargain and knows just how much a frog is worth.



IVY WALKER

A busy working mom, Ivy rarely has any time to herself. Her most prized possession is a huge diamond, which she spends a great deal of time polishing. Just how she got it, no one knows.



SWEEP

This maintenance robot travels the city, picking up trash and sweeping the streets clean. When it is not on duty, it sometimes starts cleaning people and places on its own, usually without asking first.



KONRAD

Konrad is known for being great at catching crabs and other fish. He is also highly skilled at napping, which he says is more of a science than an art. It is said that Konrad can fall asleep anywhere within five seconds.

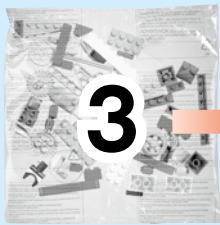
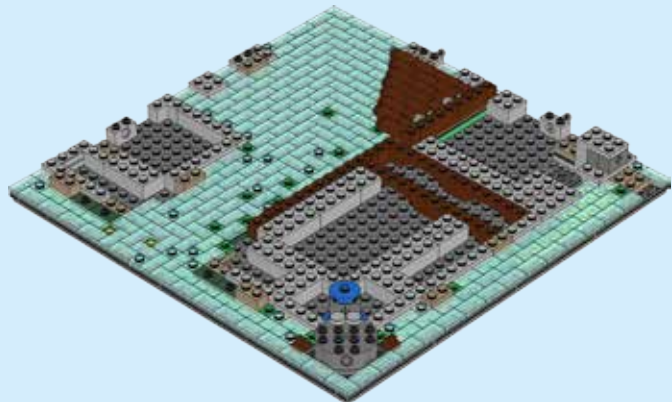
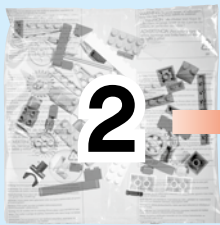
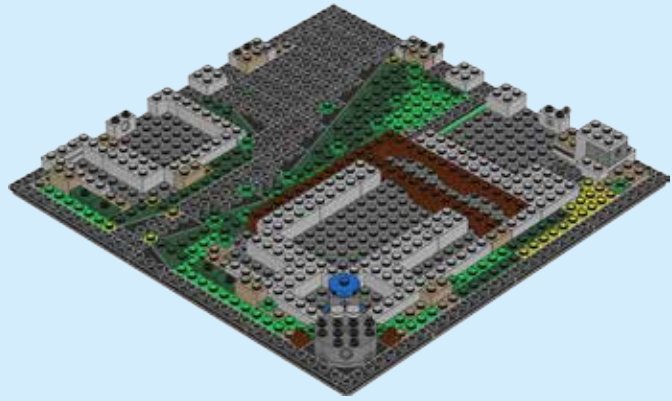

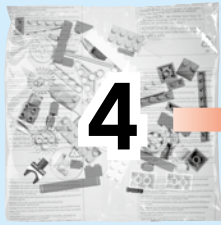

4

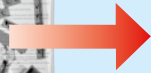

5



6



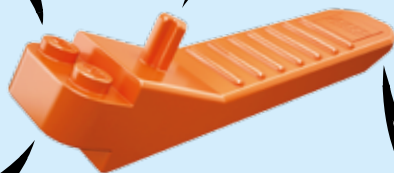
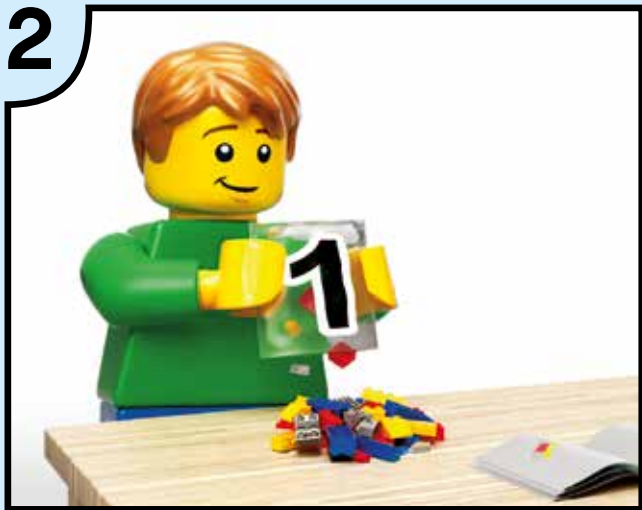

LEGO.com/brickseparator

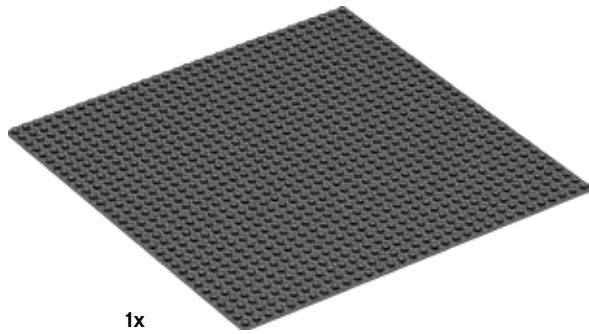

+



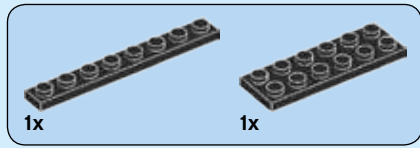

1

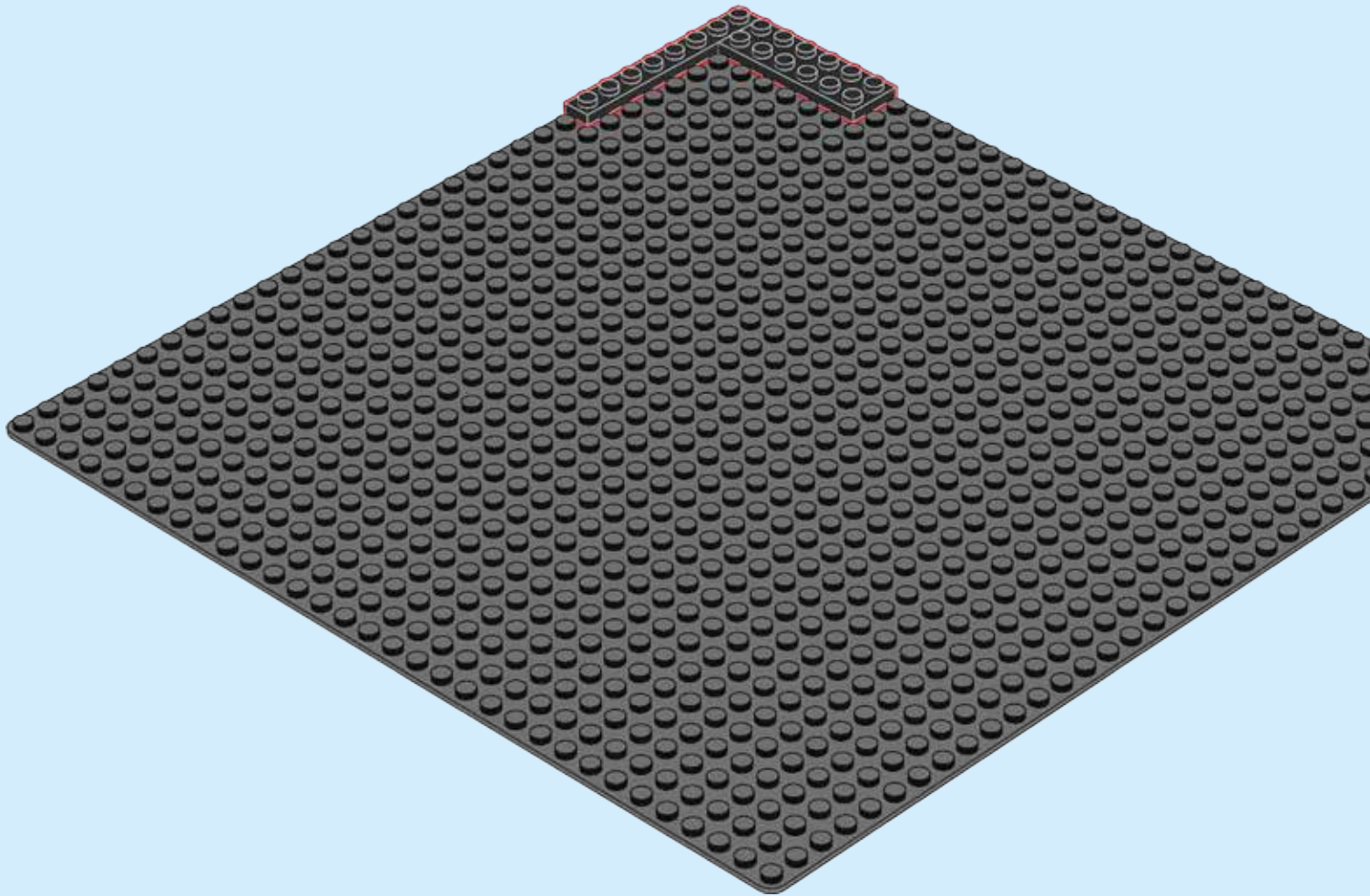

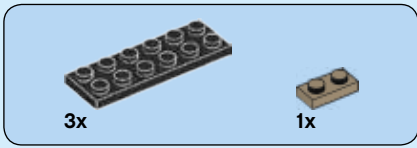

2

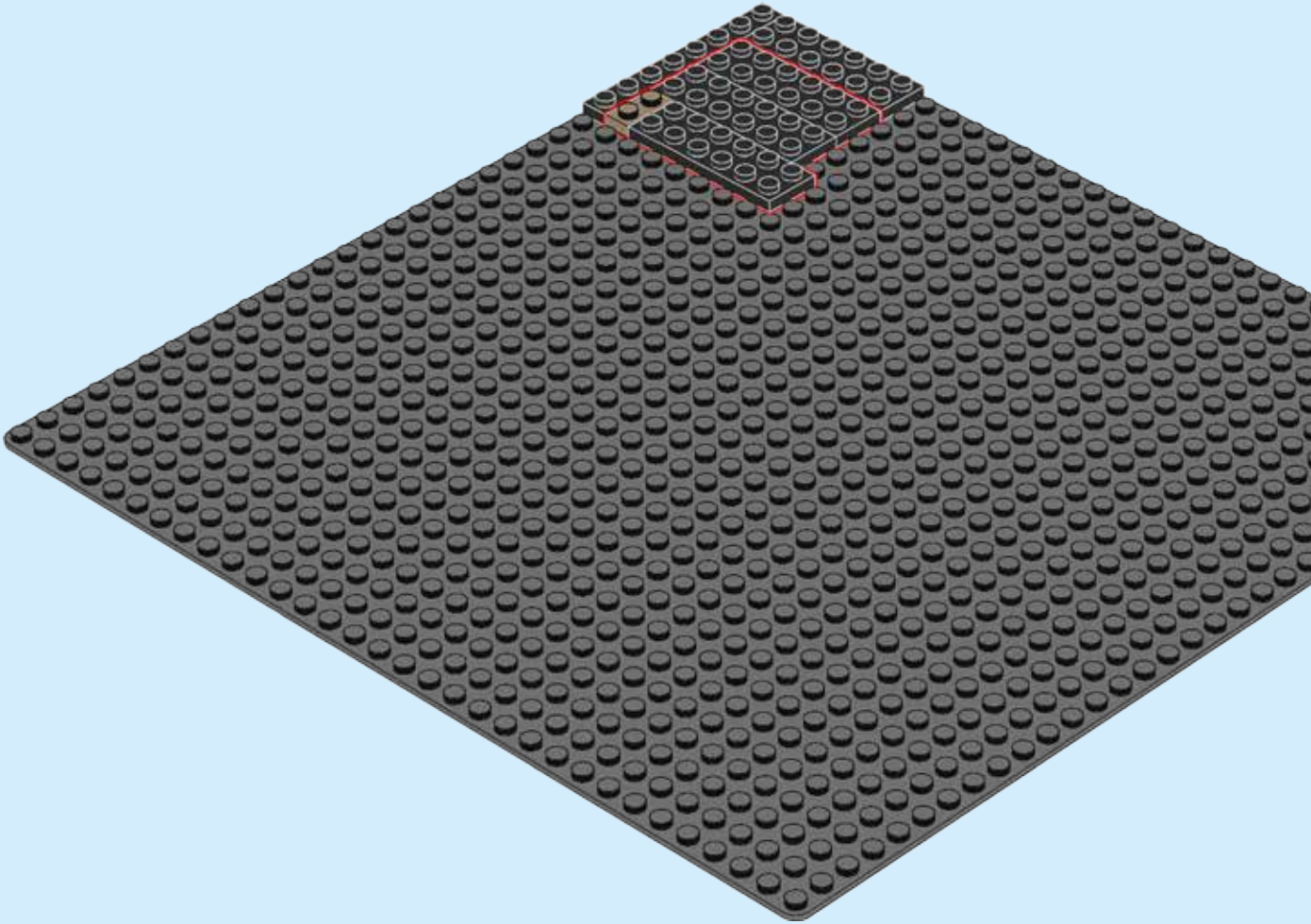

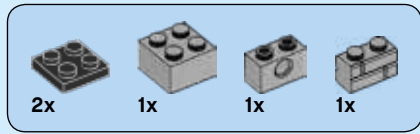

3

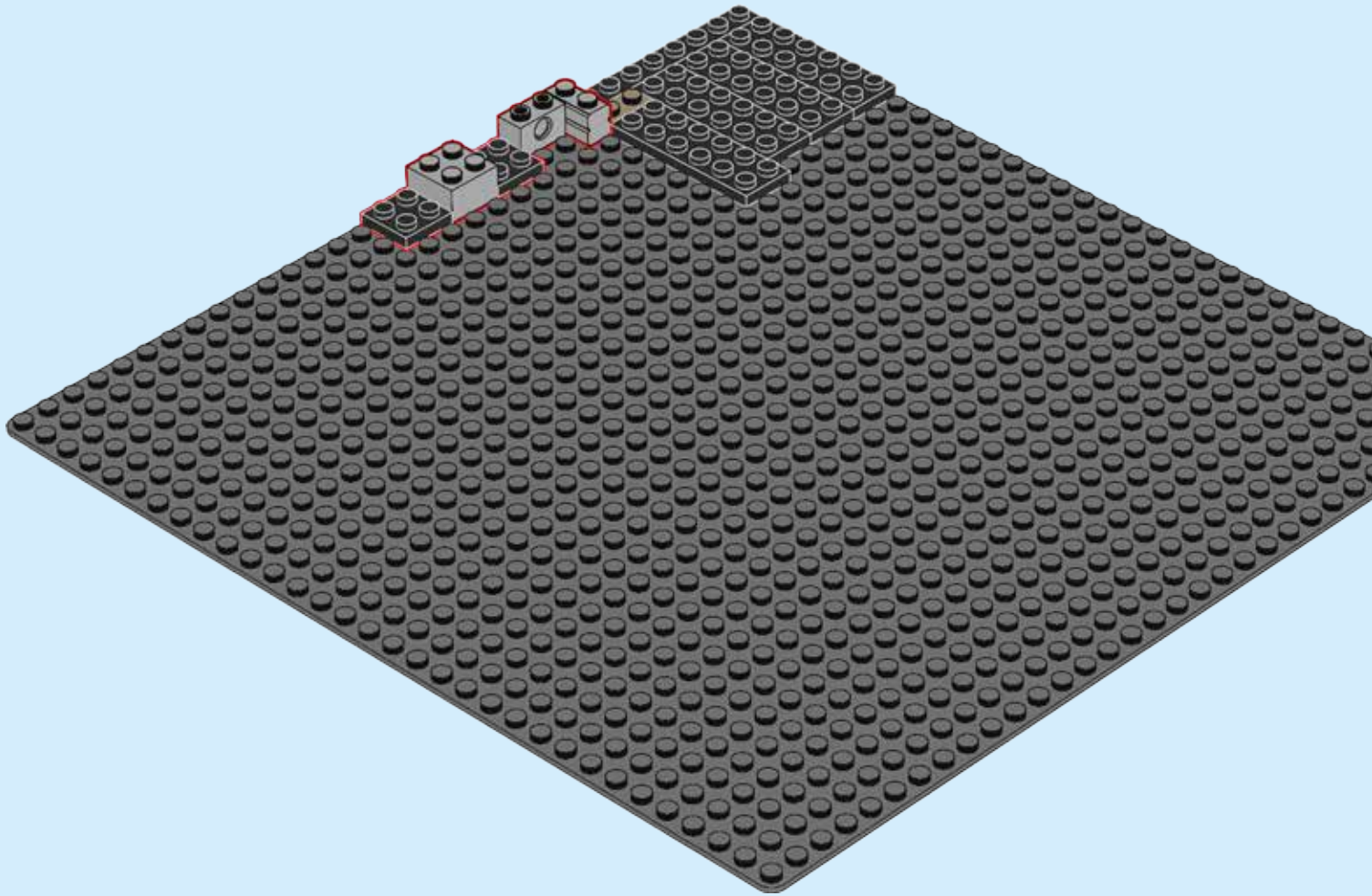

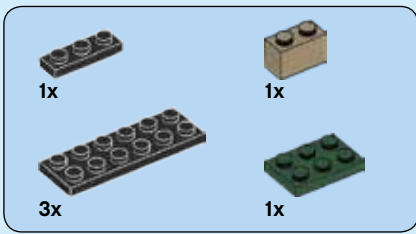

4

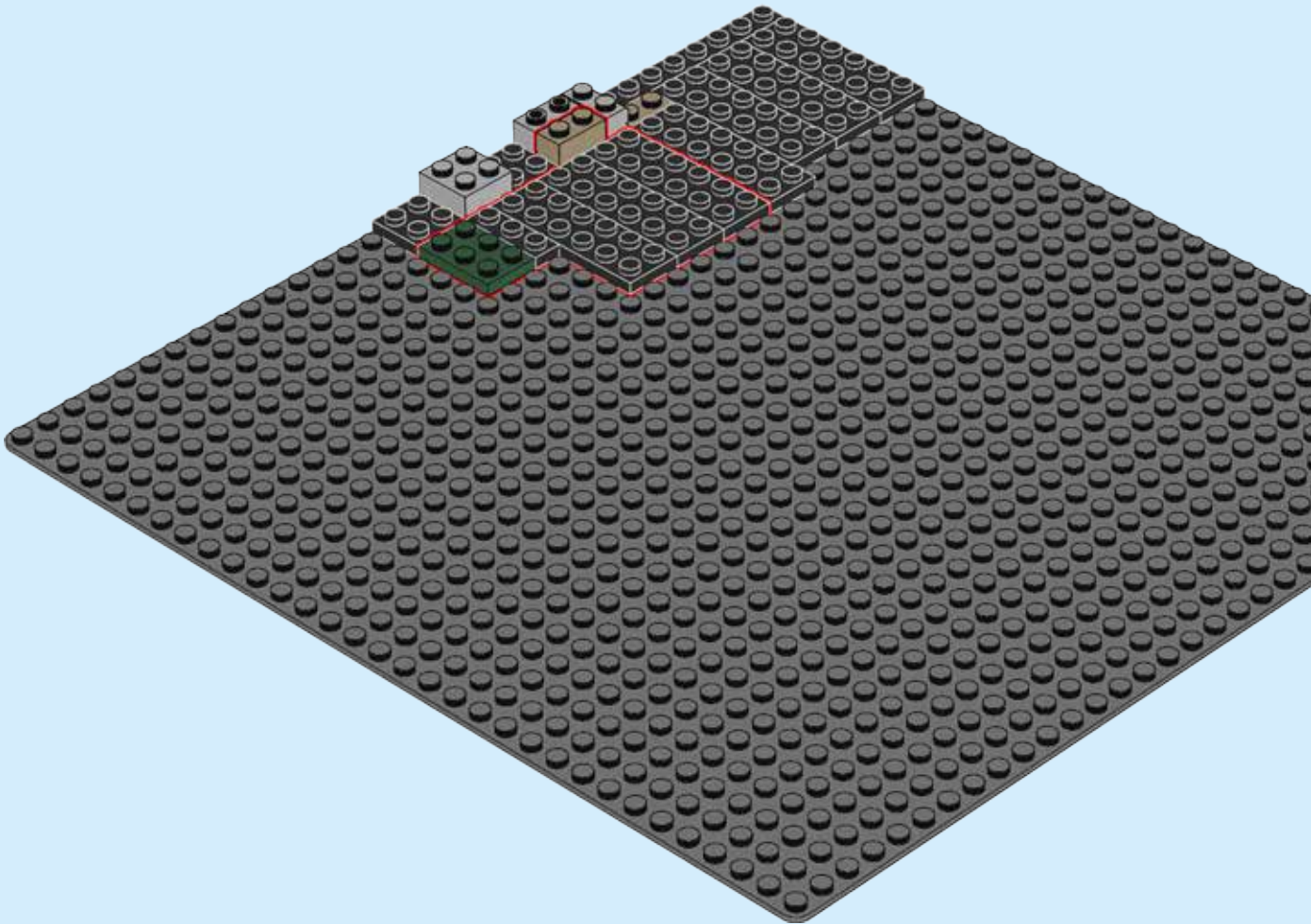

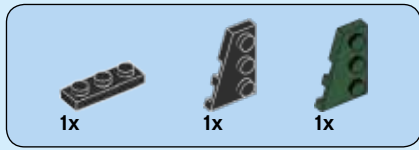

5

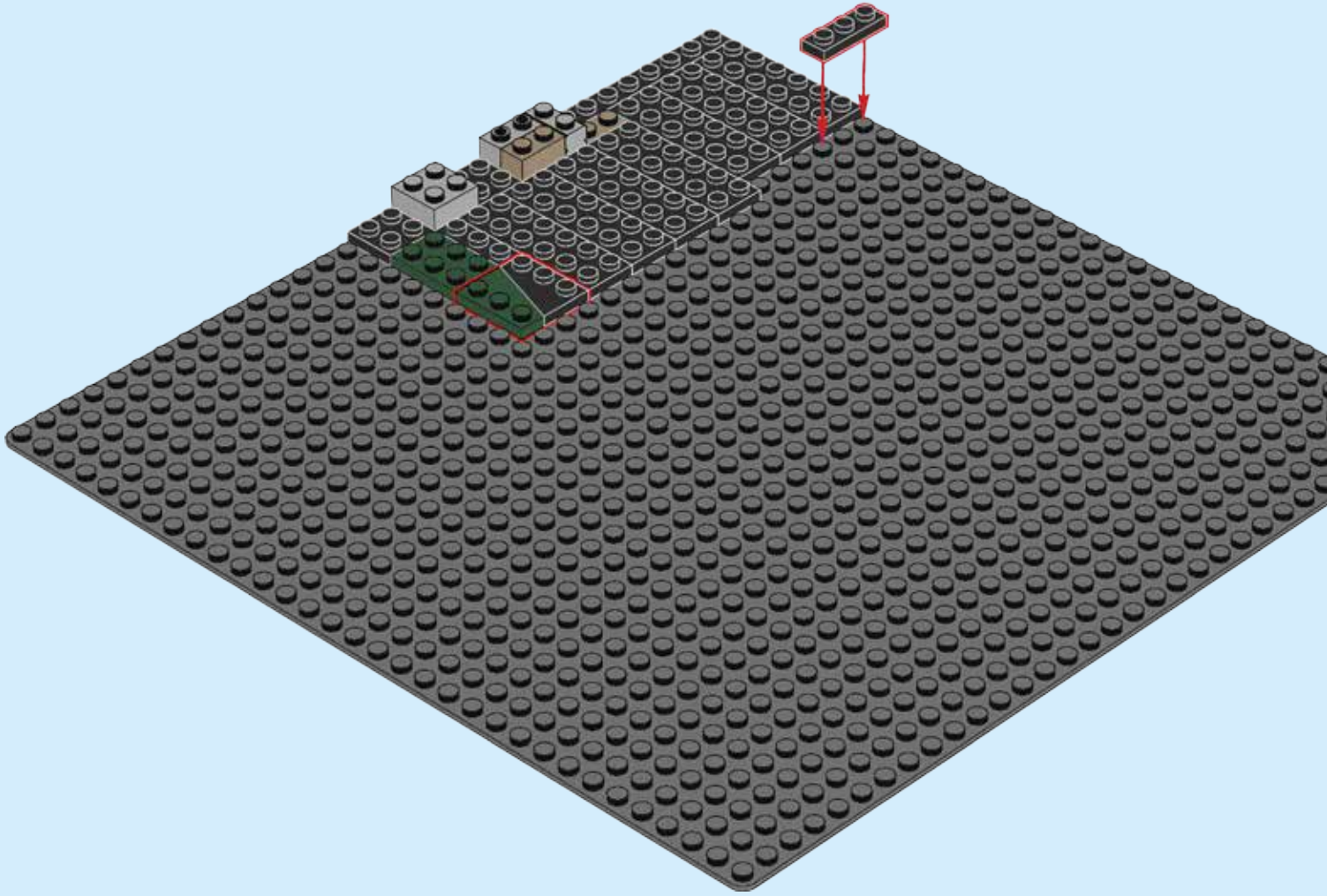

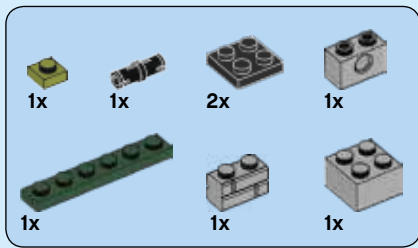

6

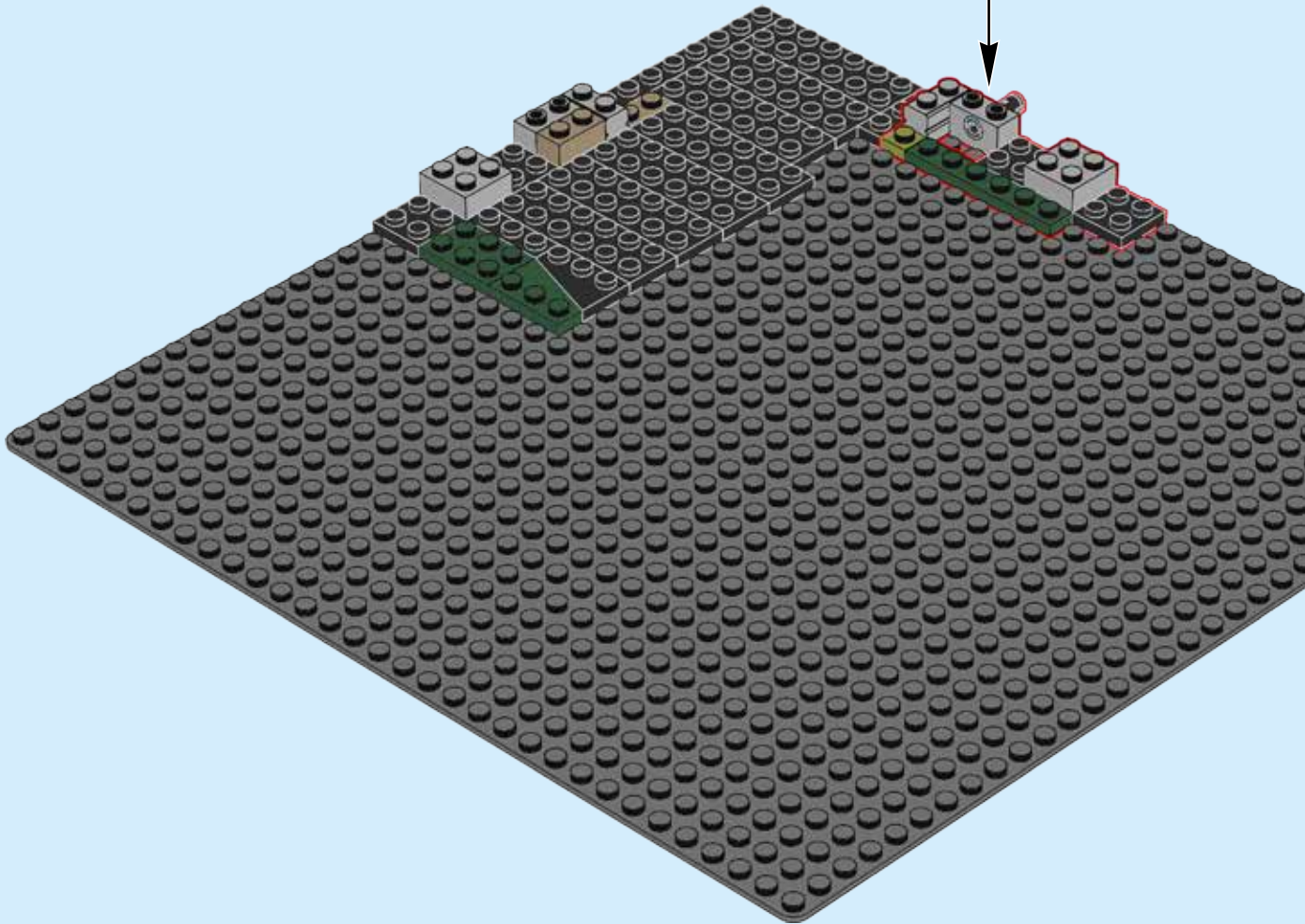
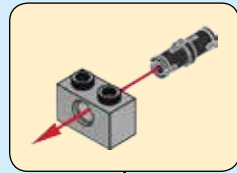

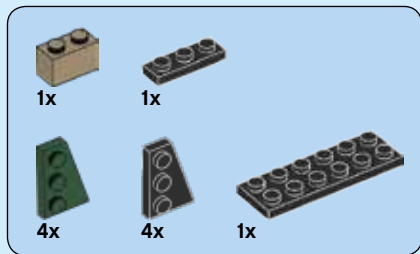

7

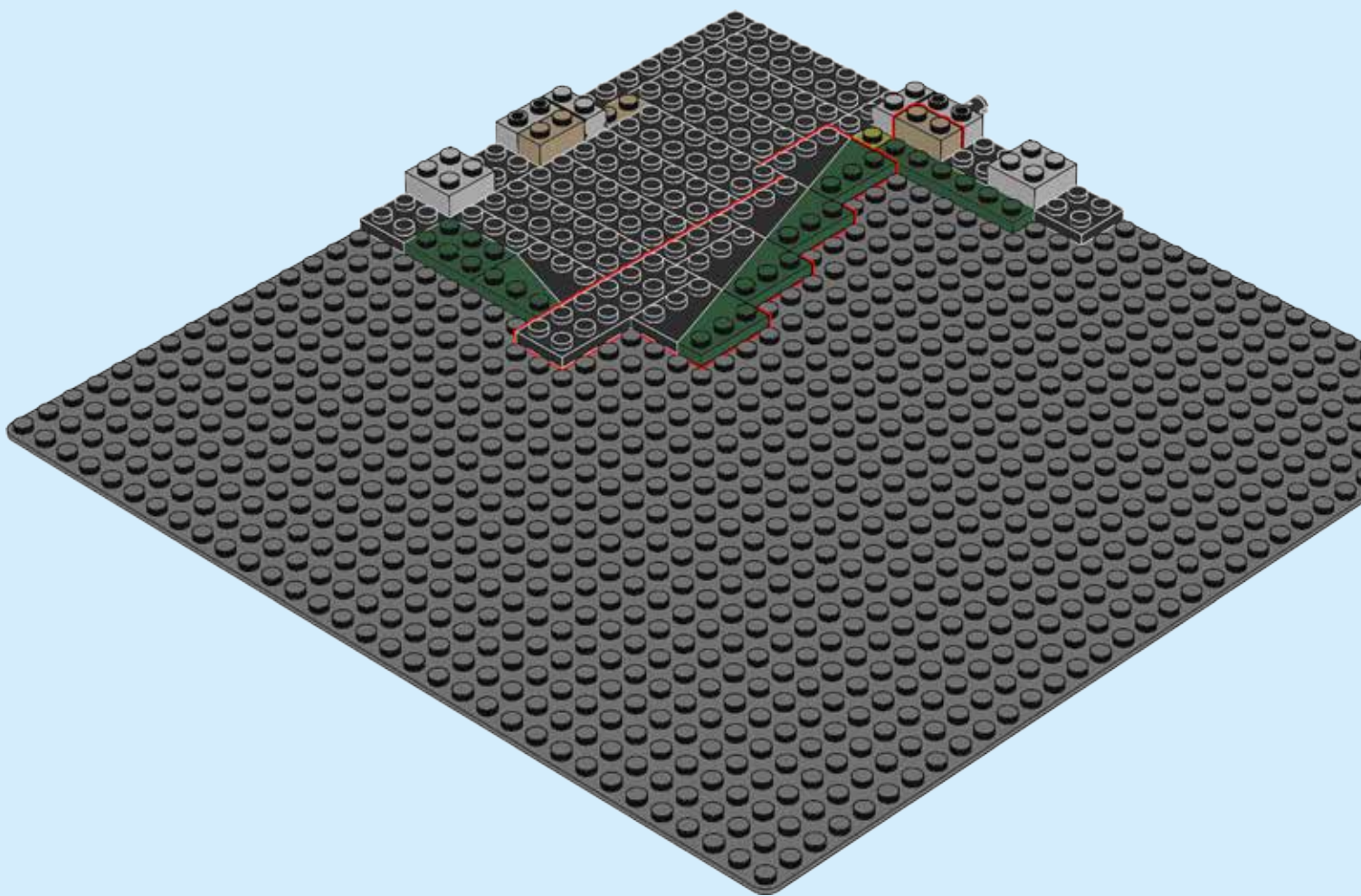

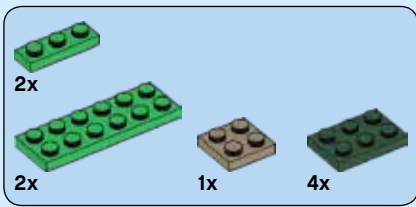

8

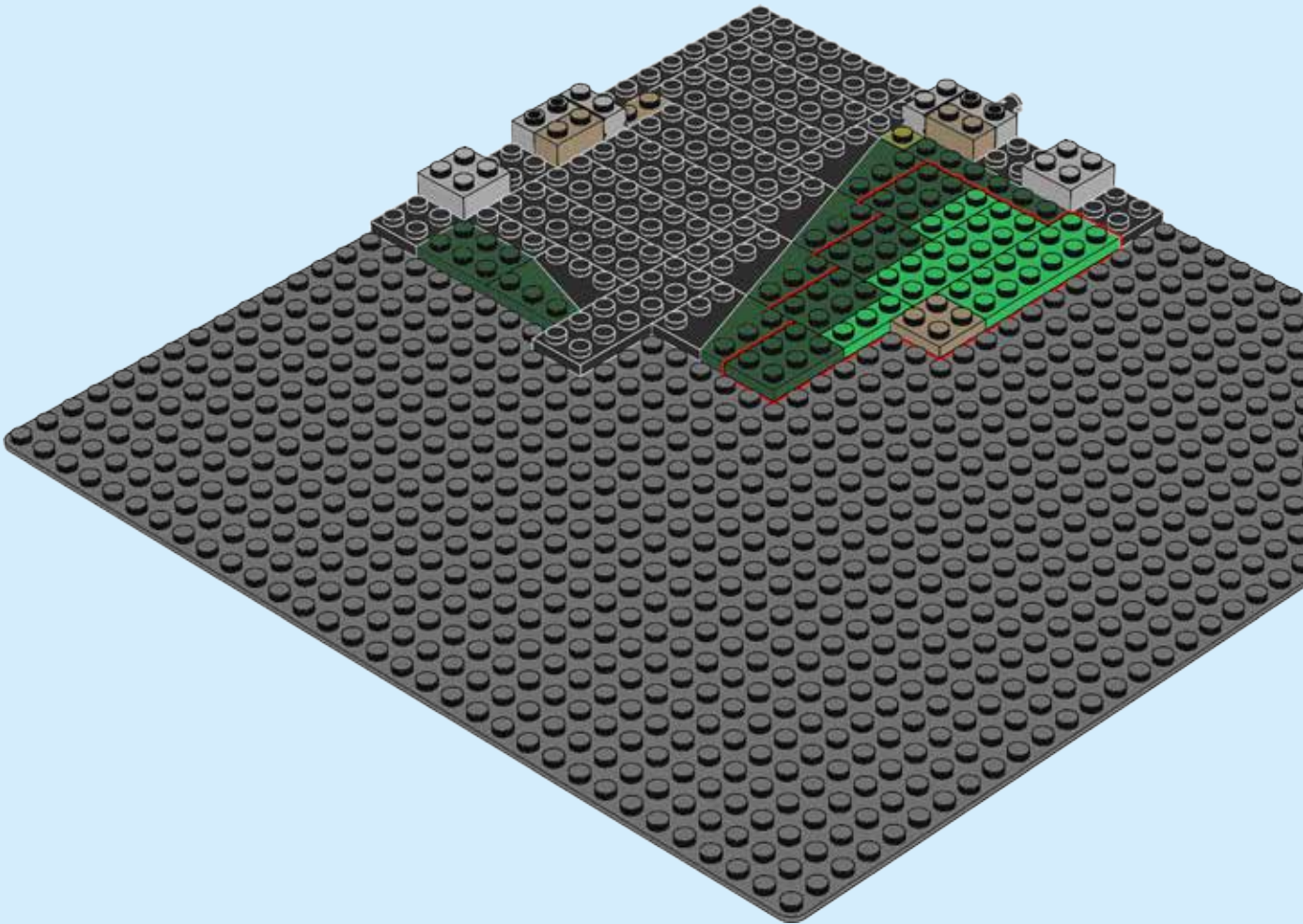

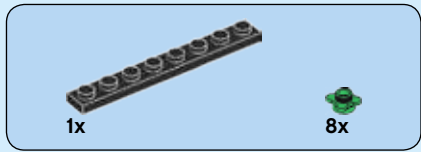

9

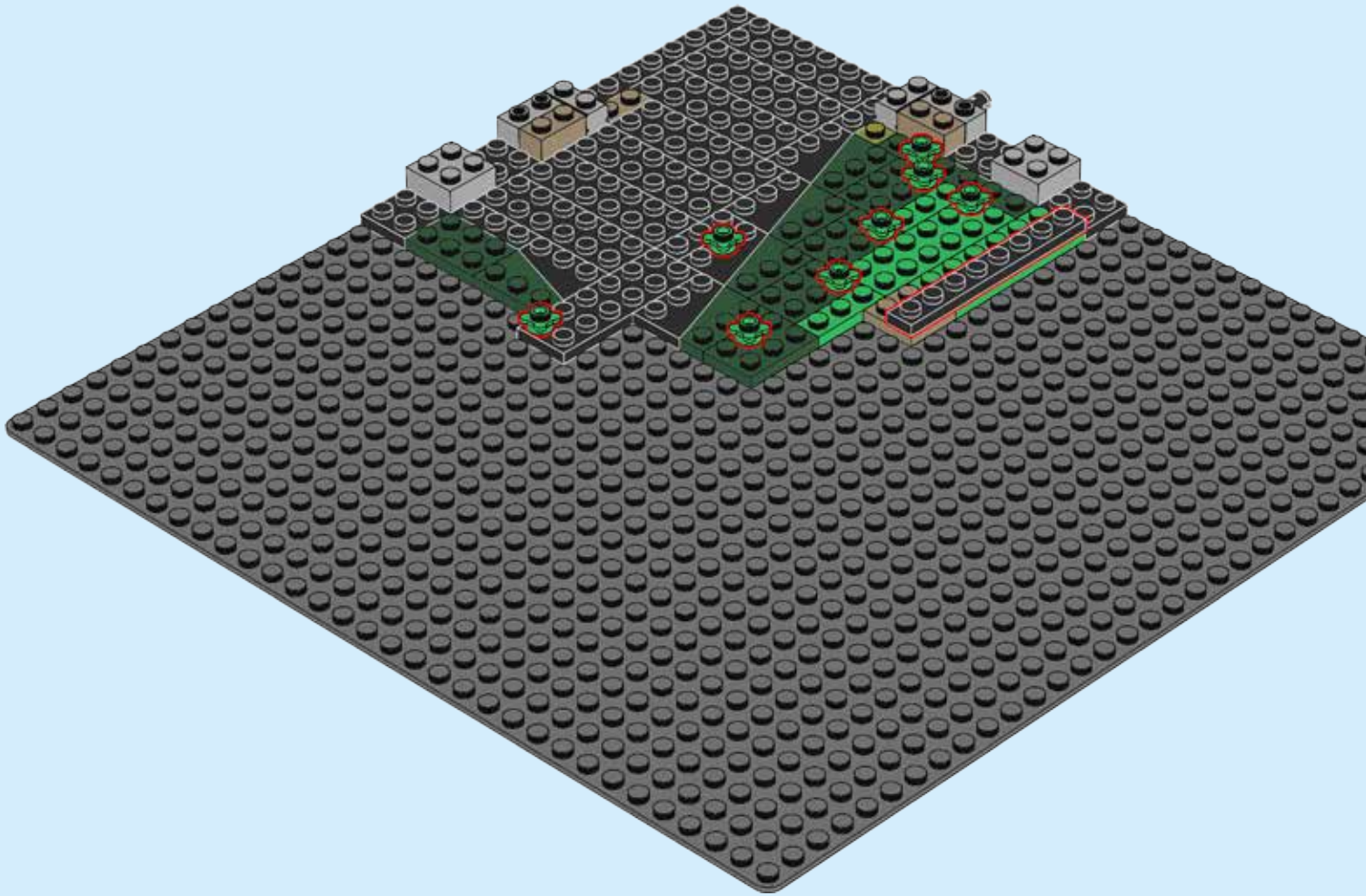

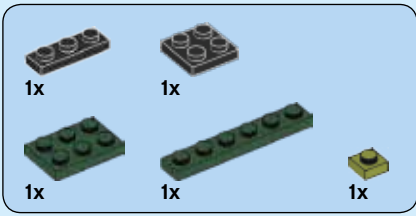

10

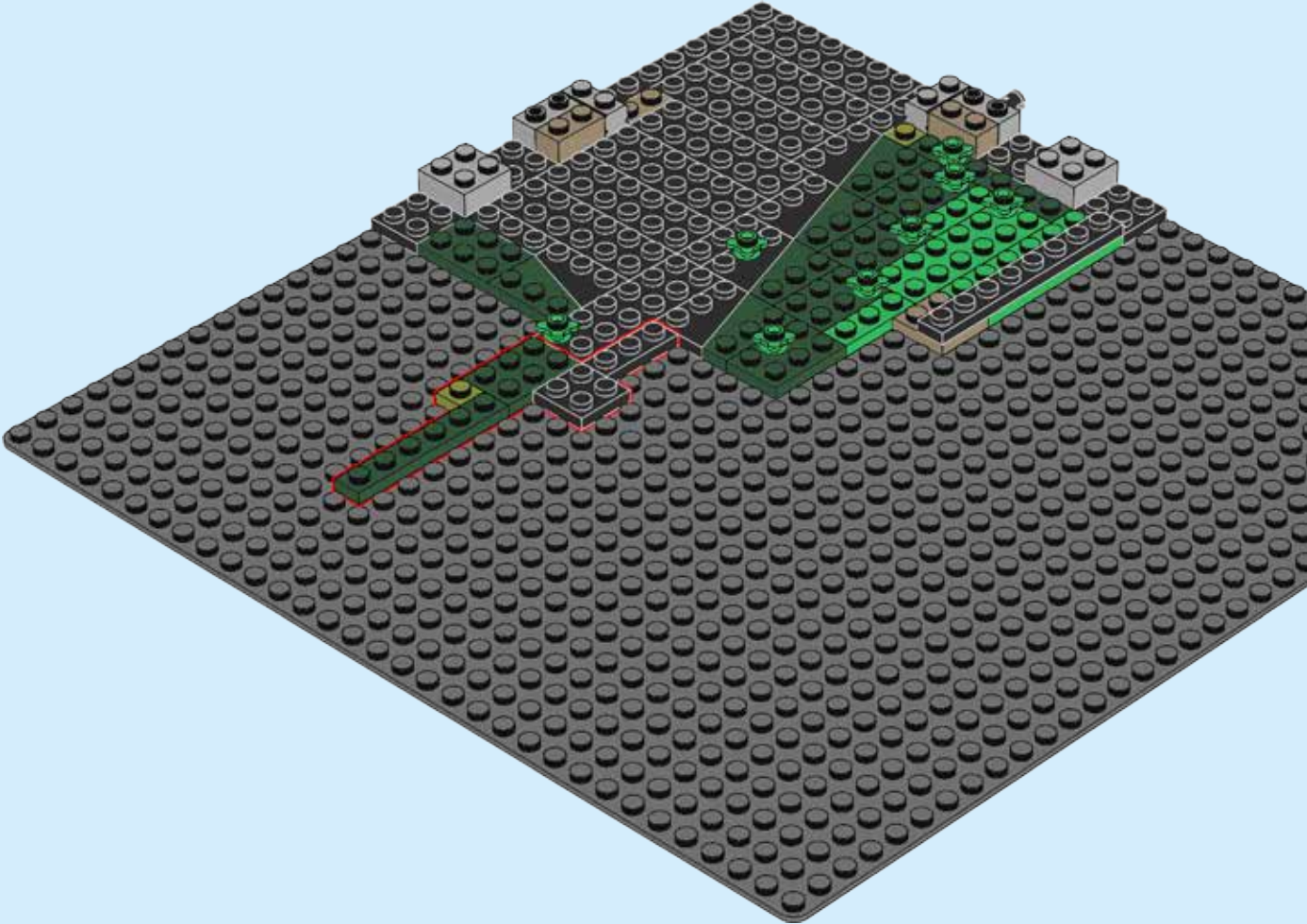

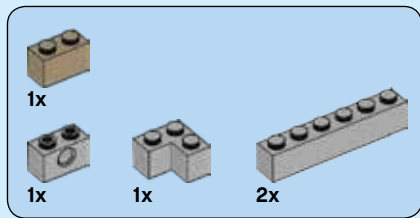

11

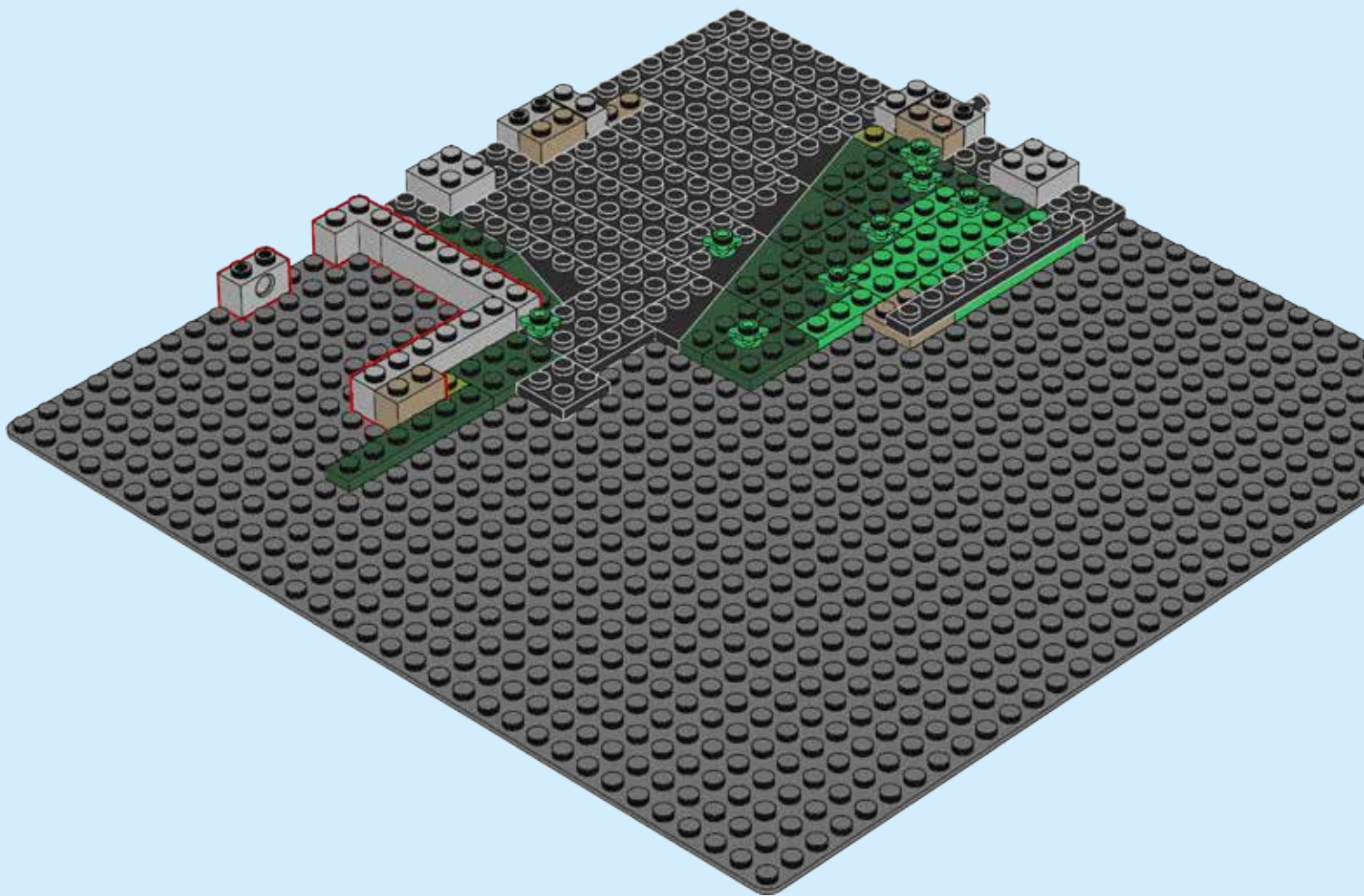

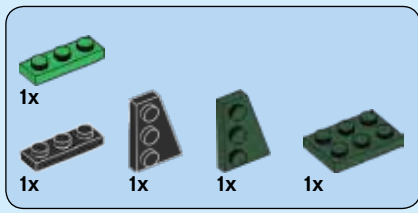

12

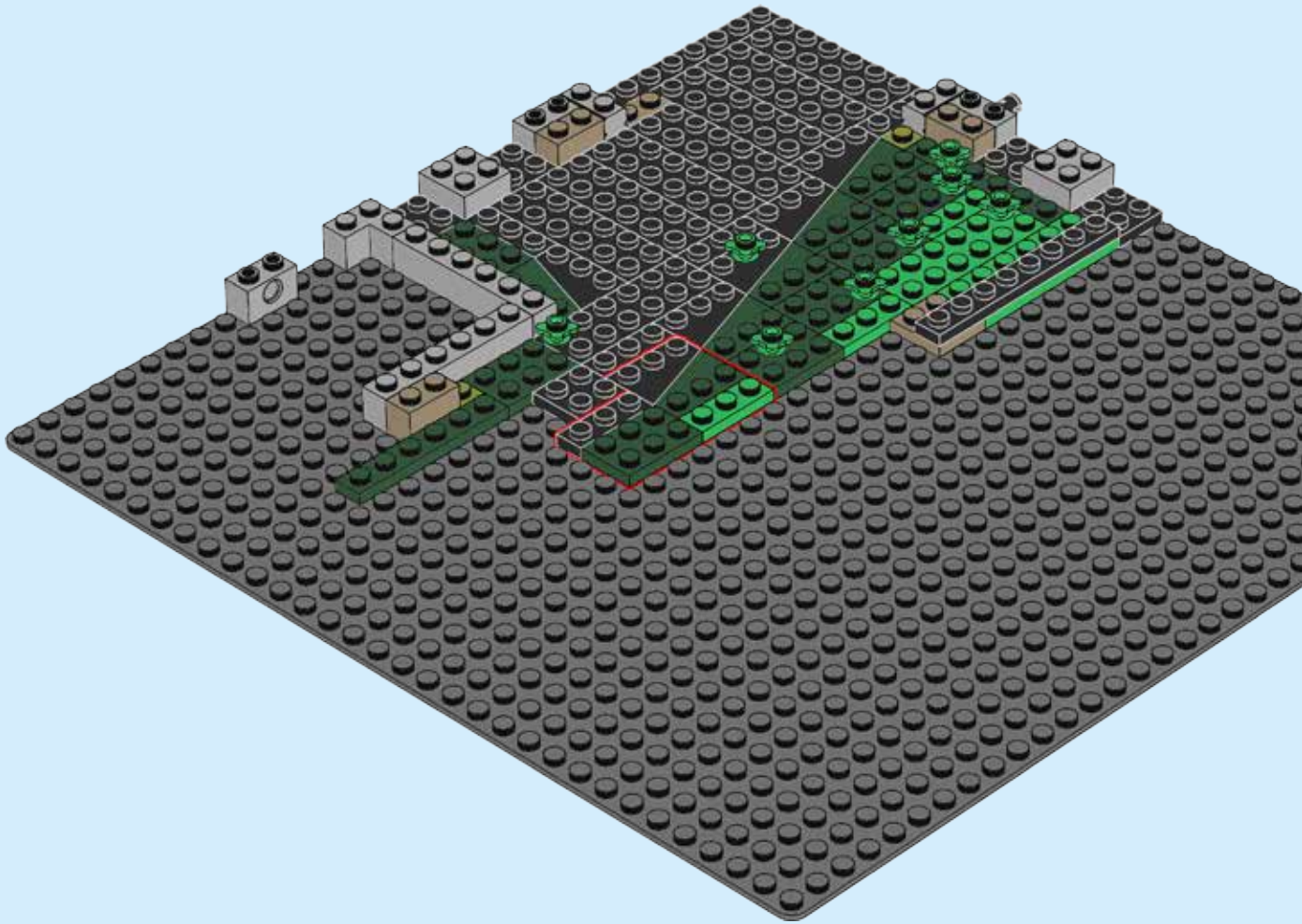

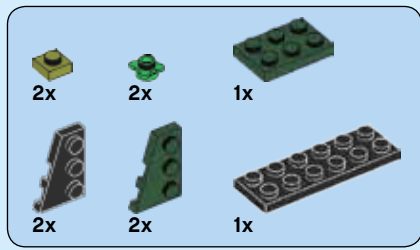

13

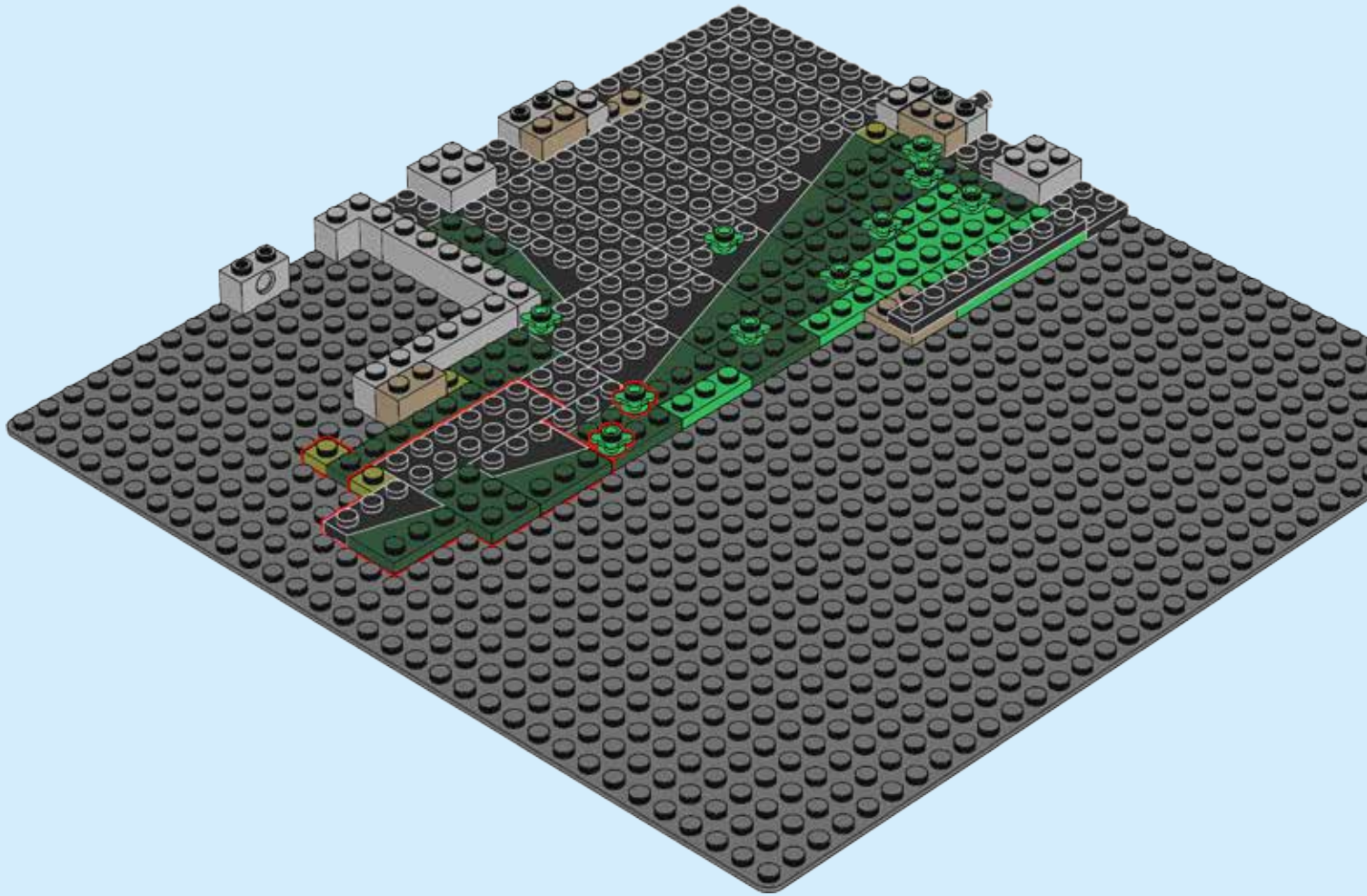

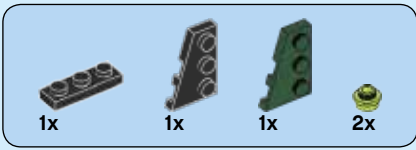

14

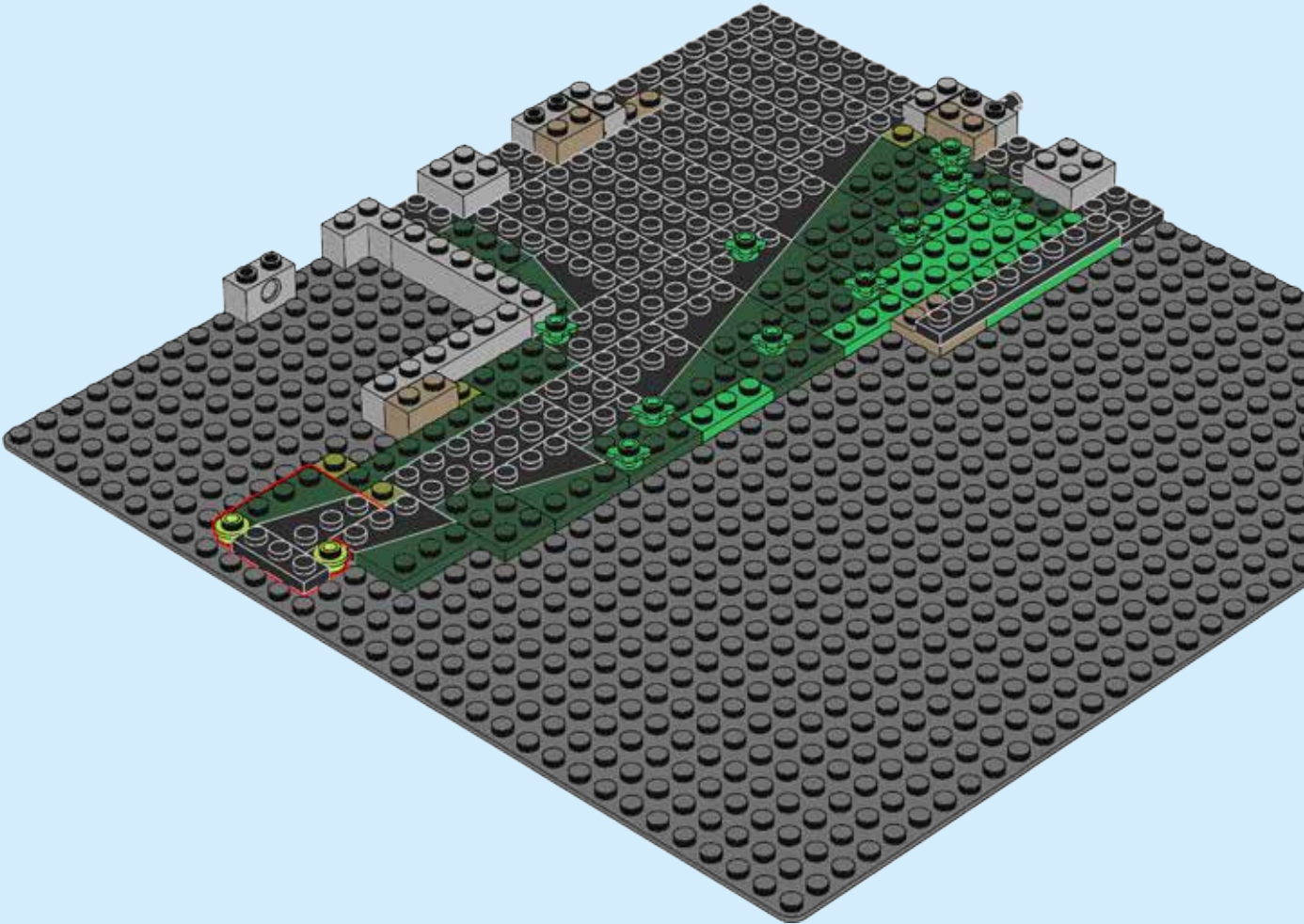

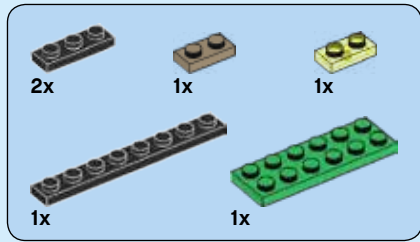

15

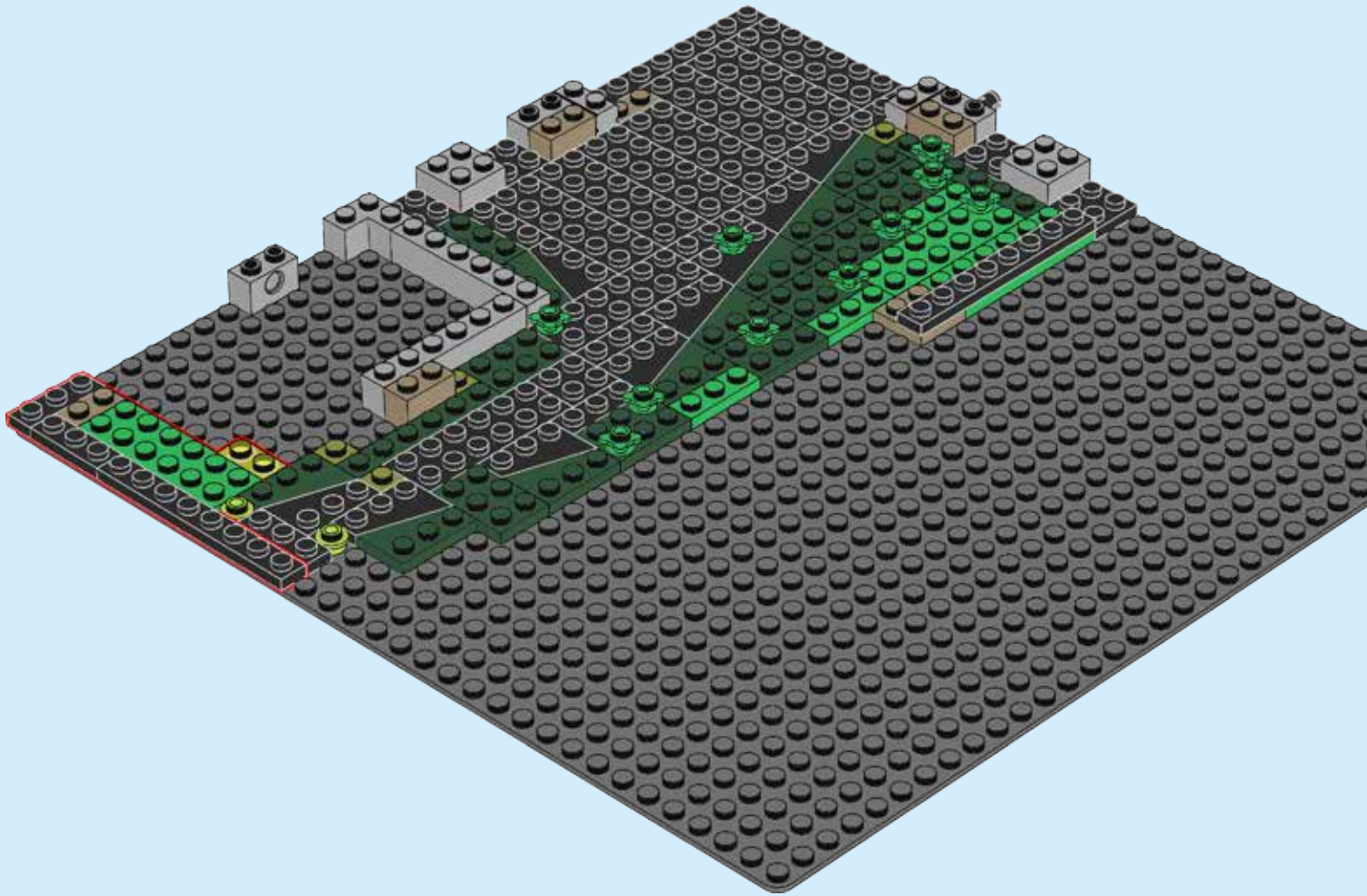

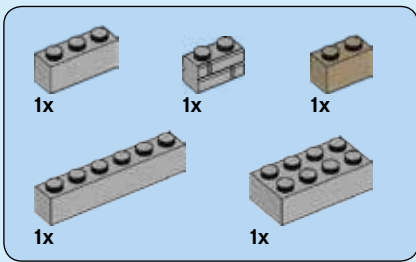

16

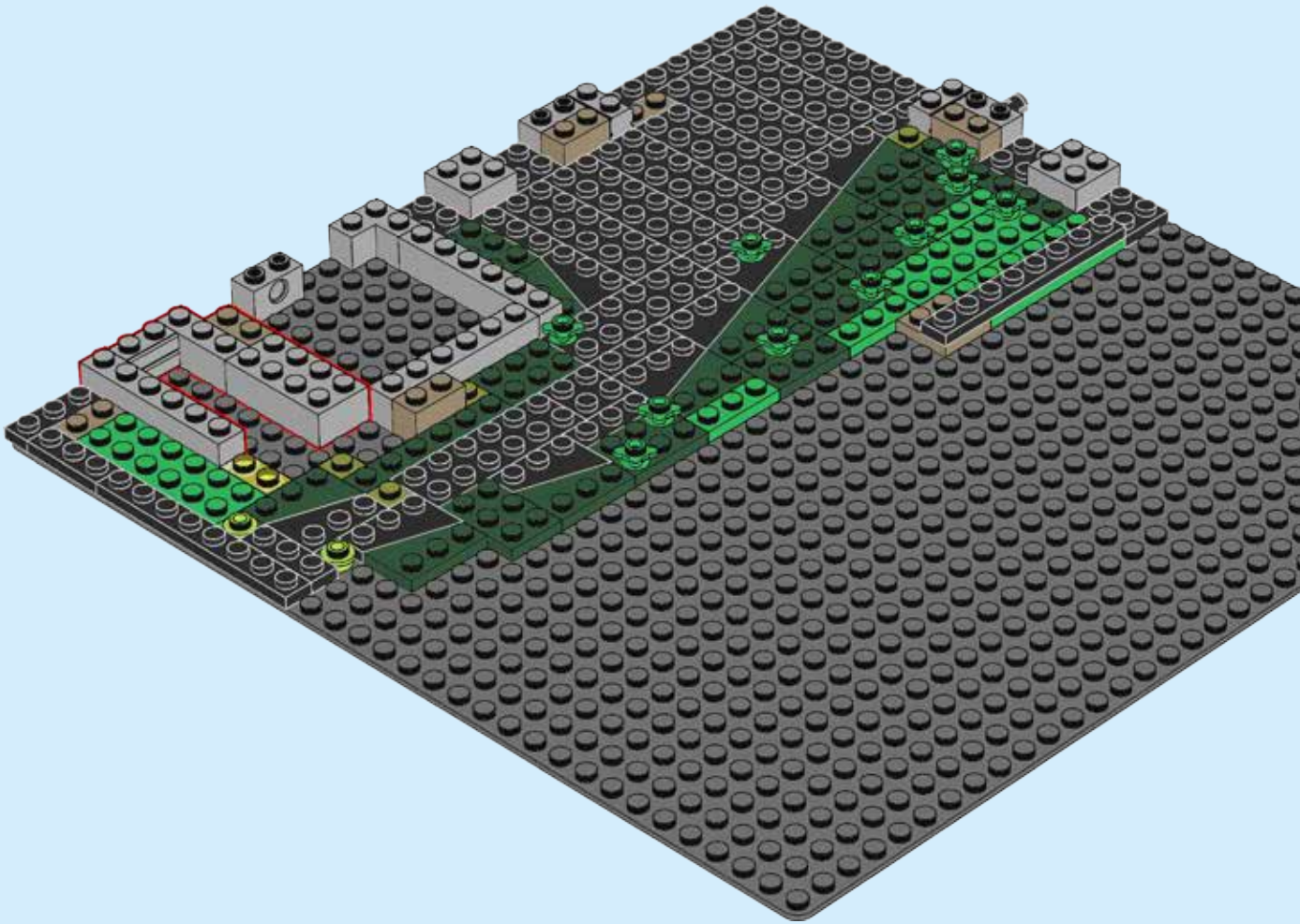



17

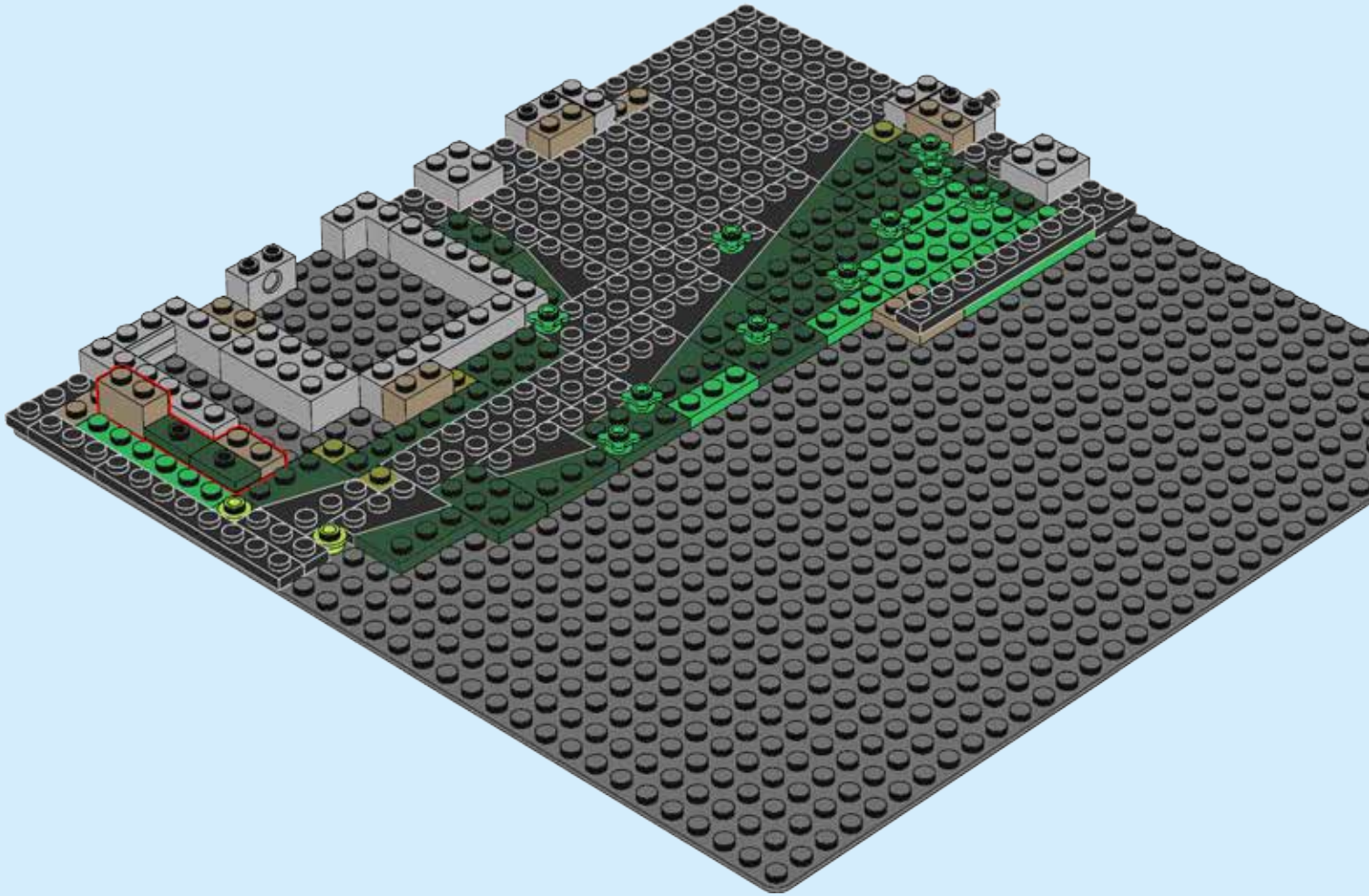

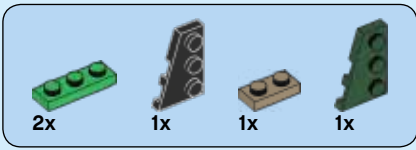

18

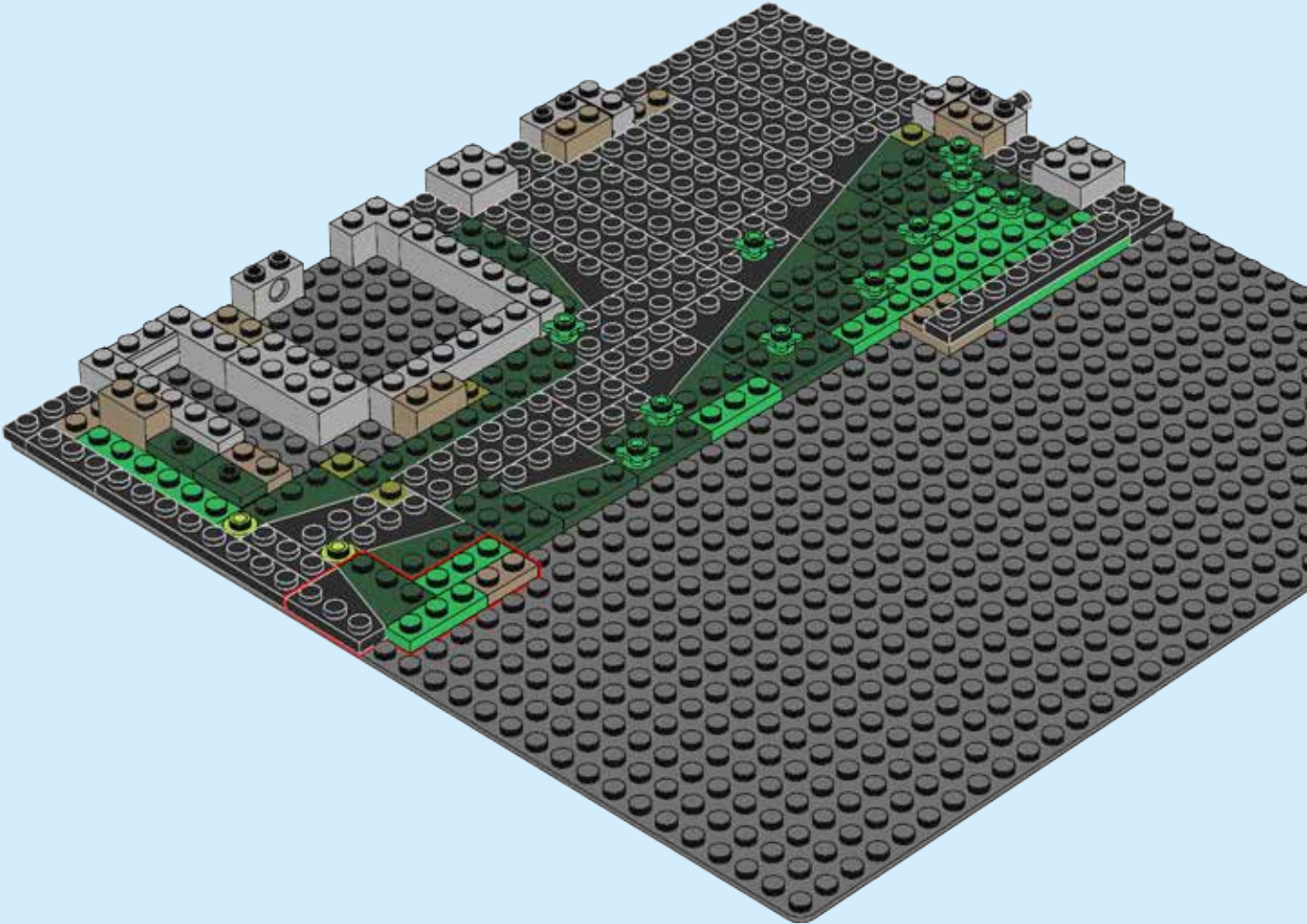

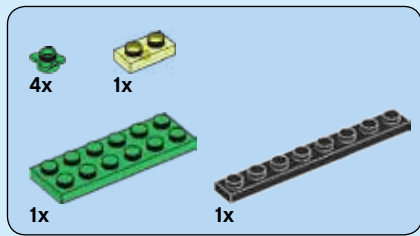

19

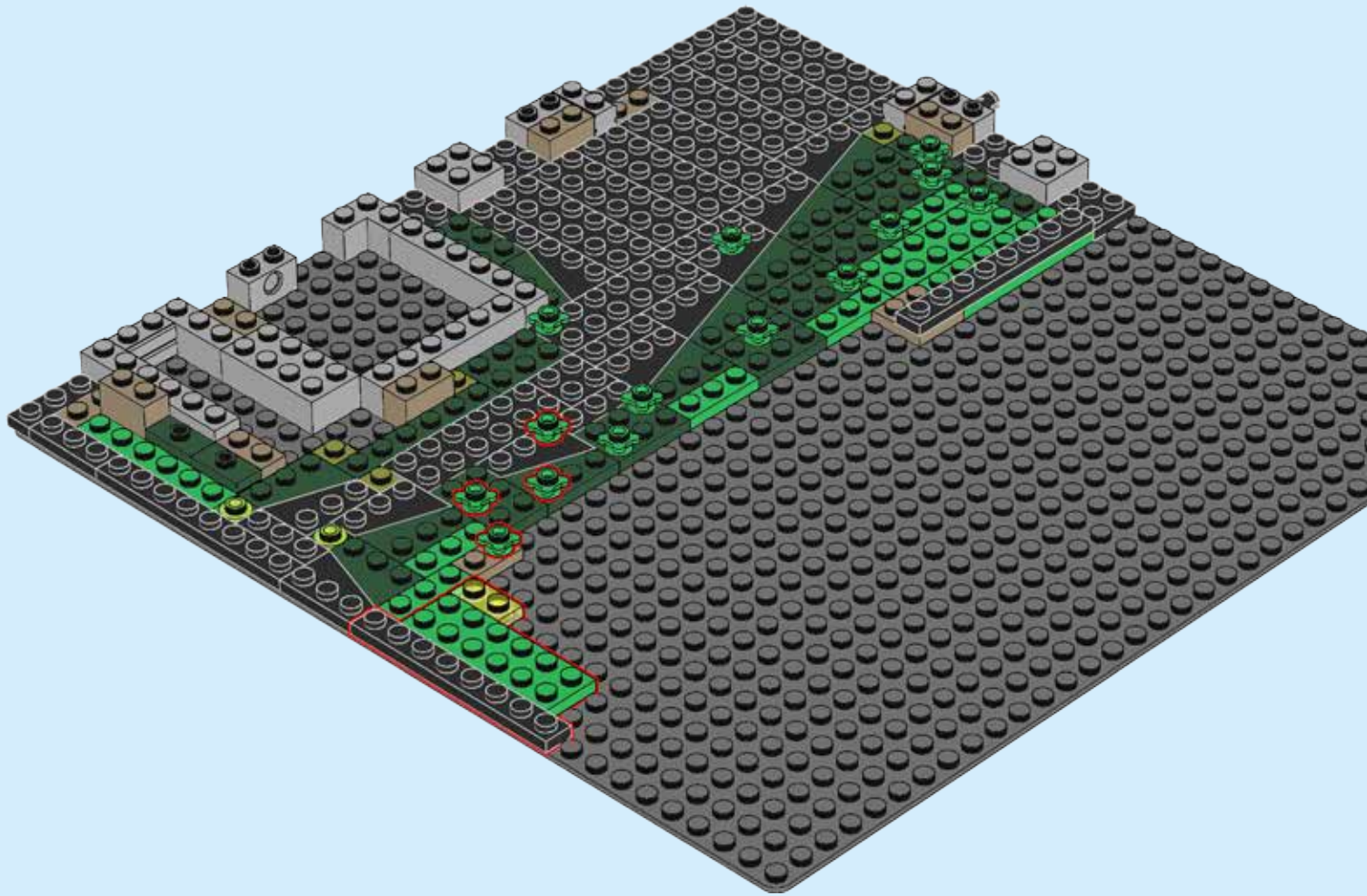

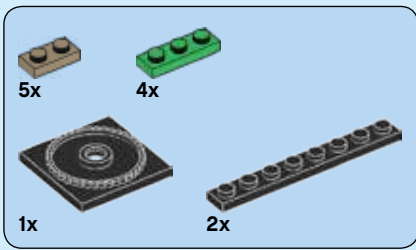

20

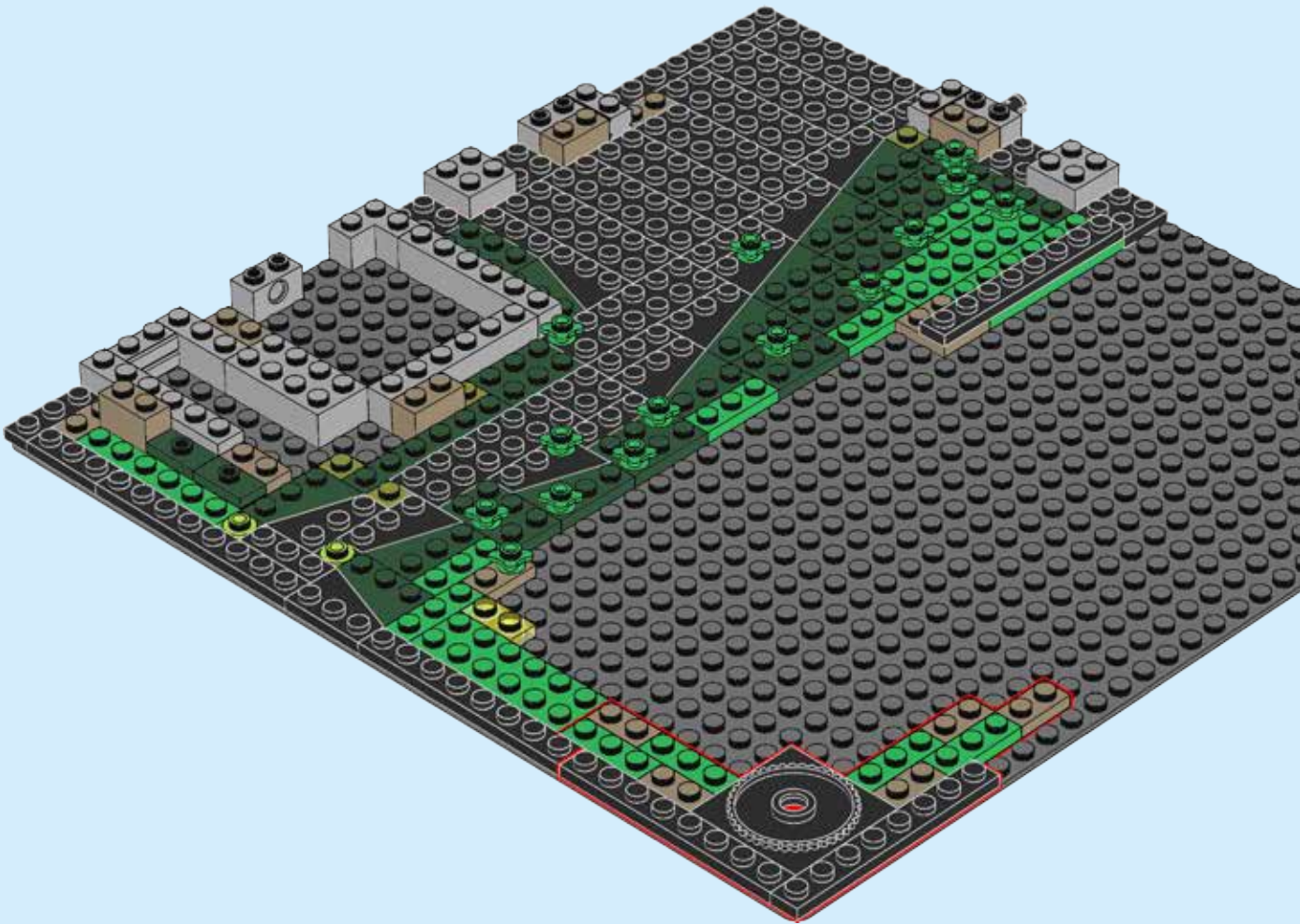

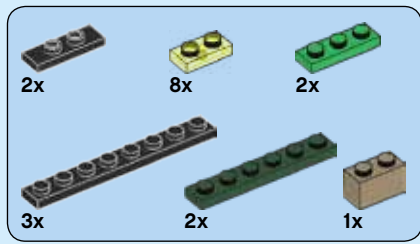

21

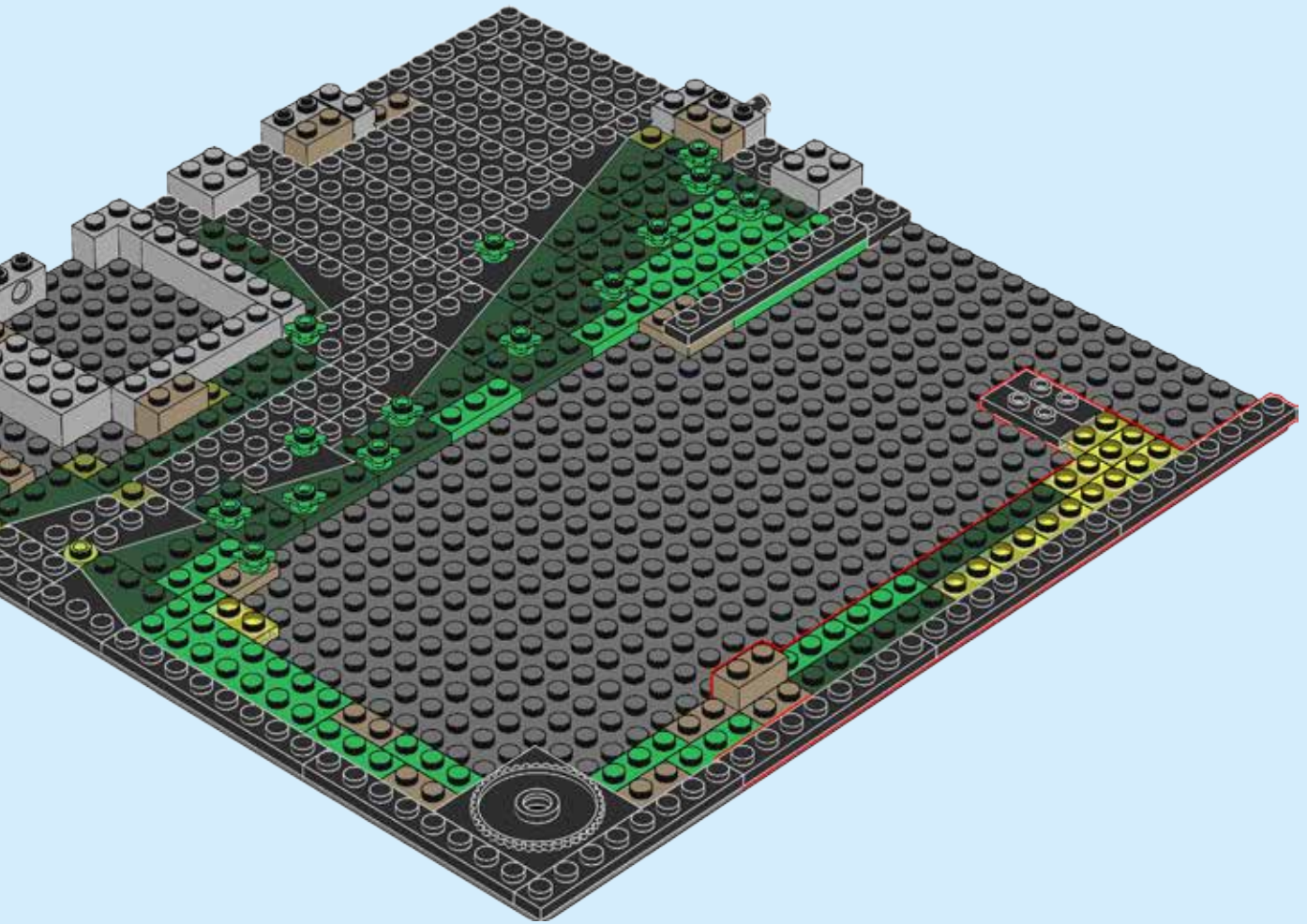

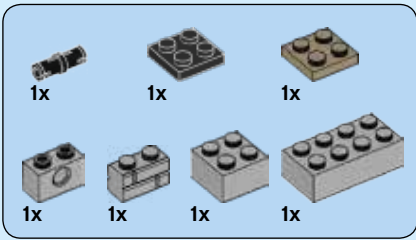

22

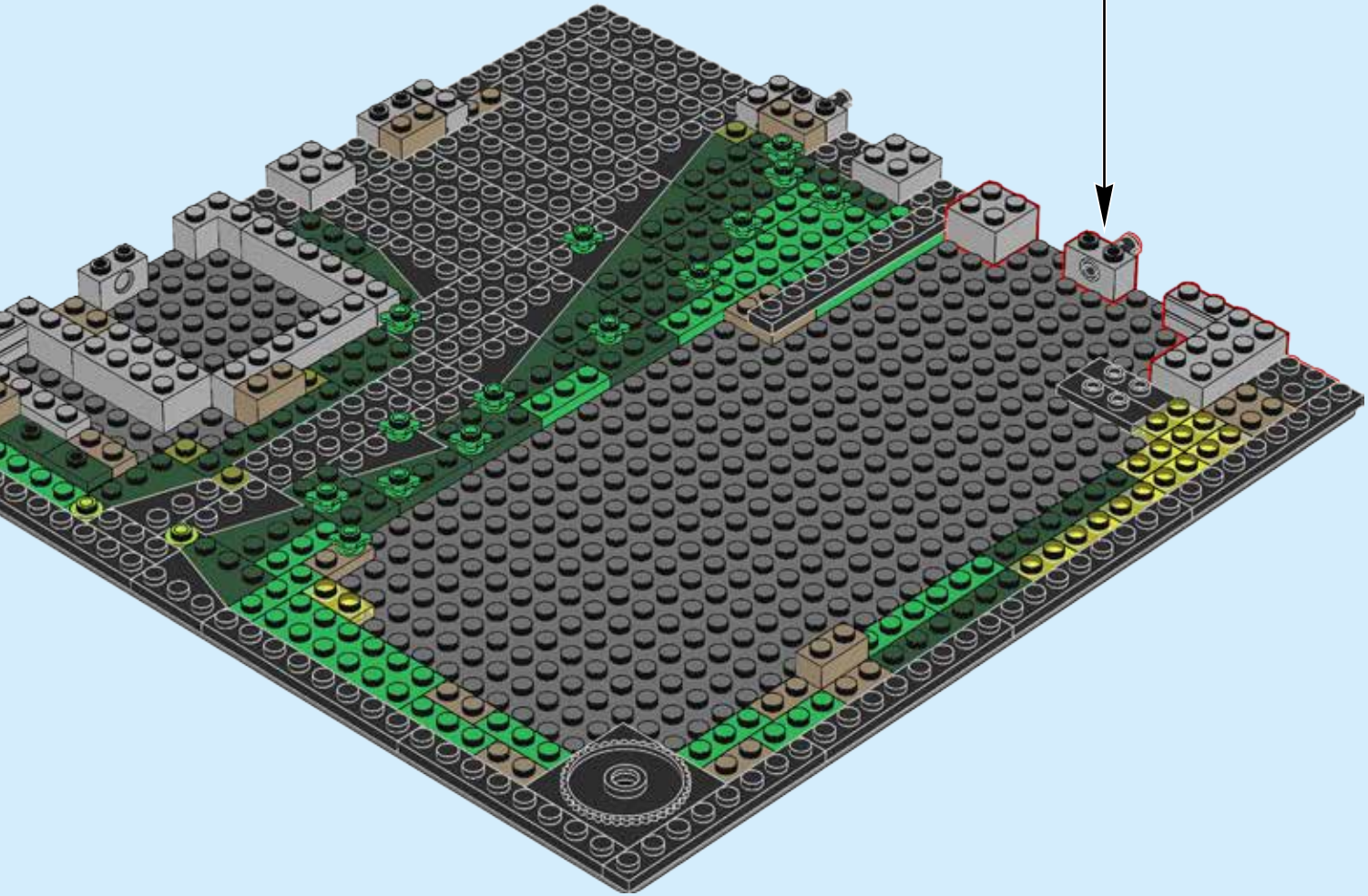
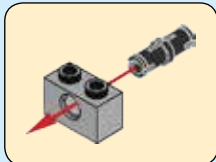



23

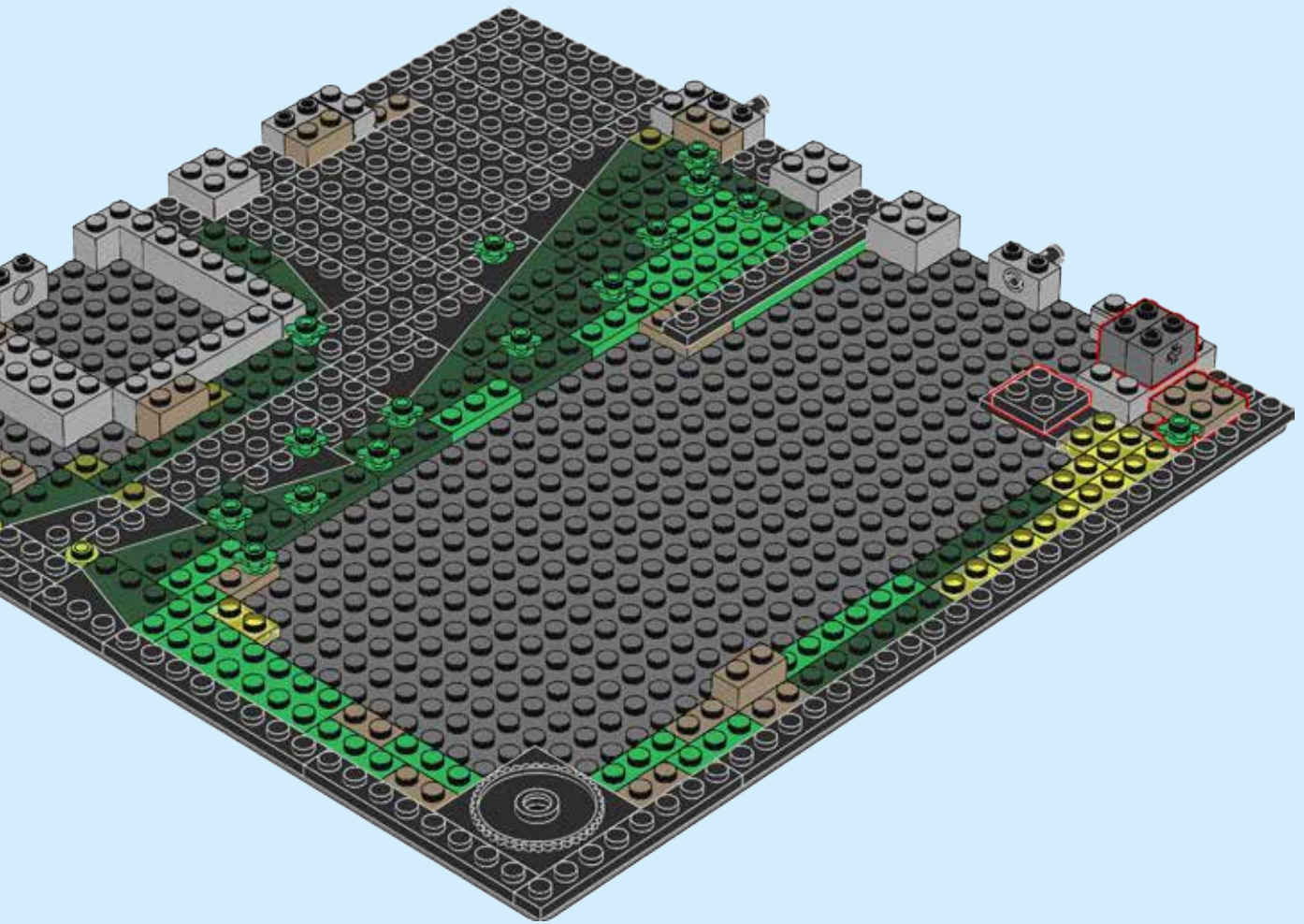

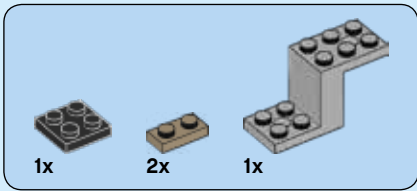

24

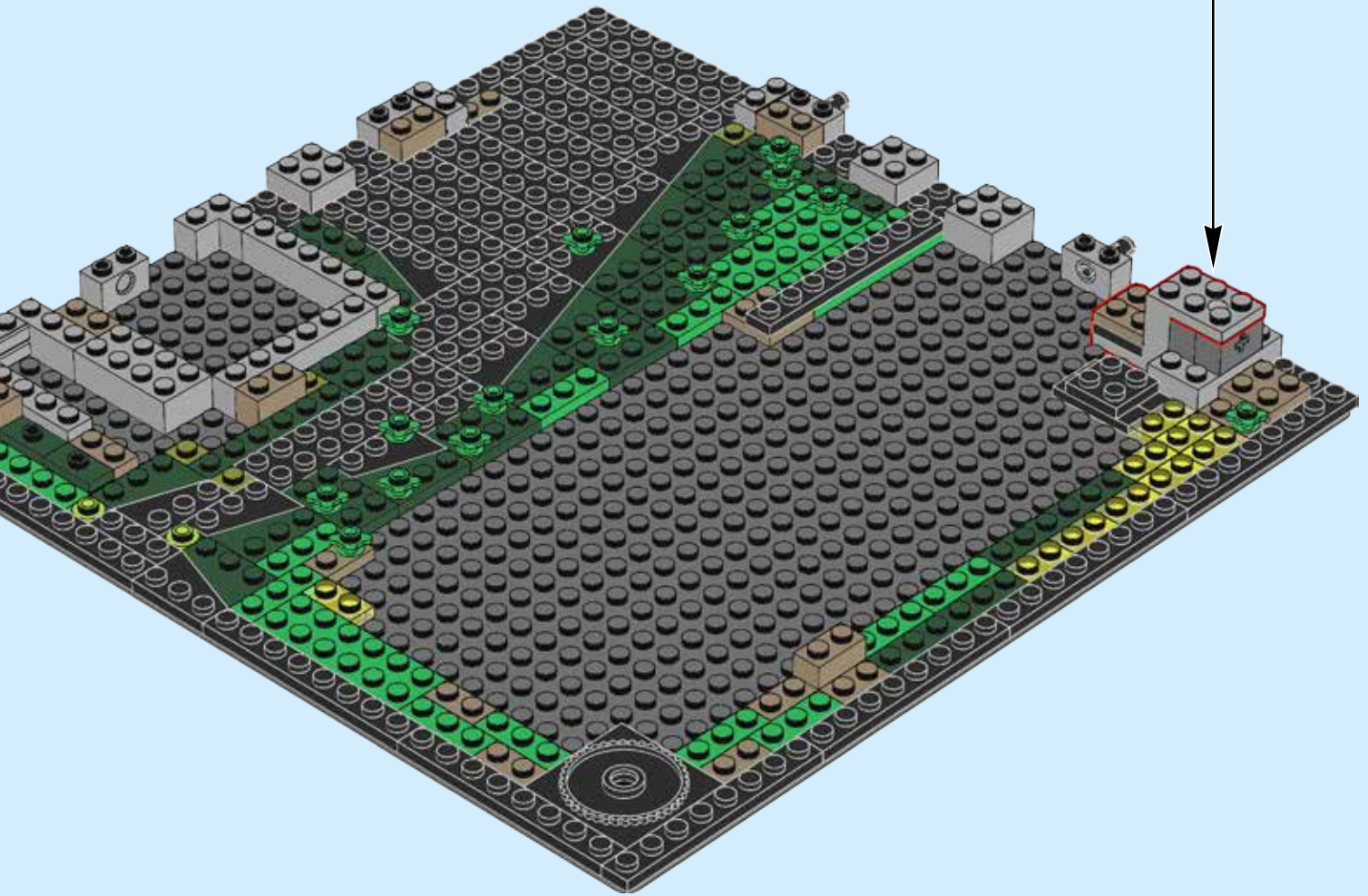
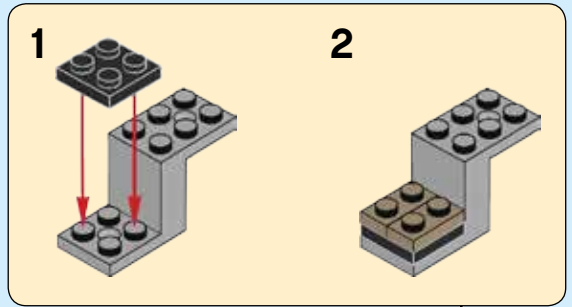

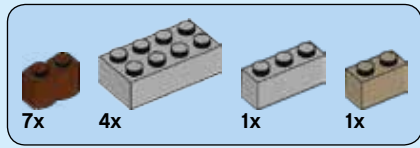

25

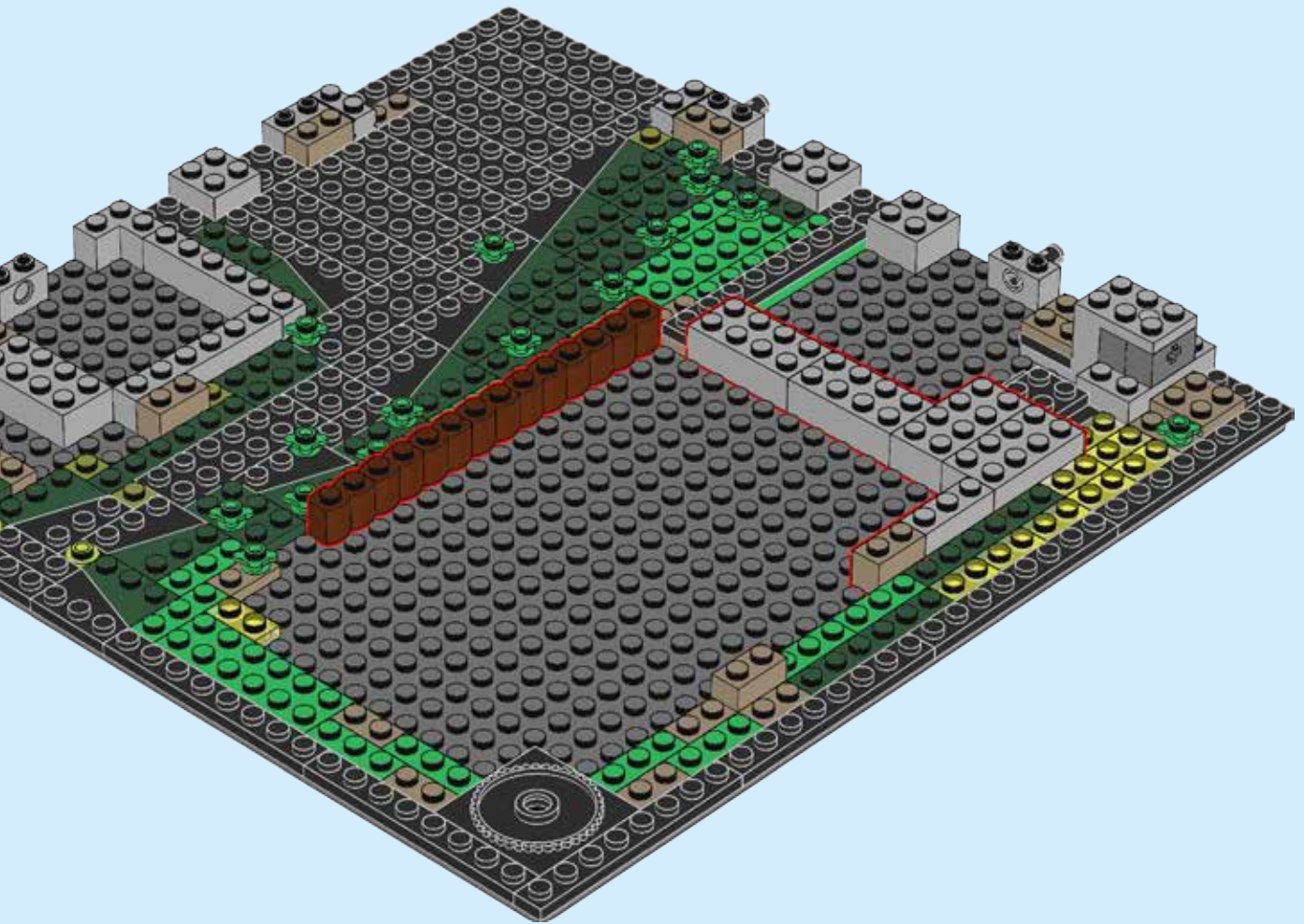

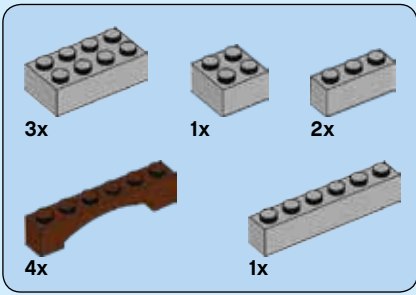

26

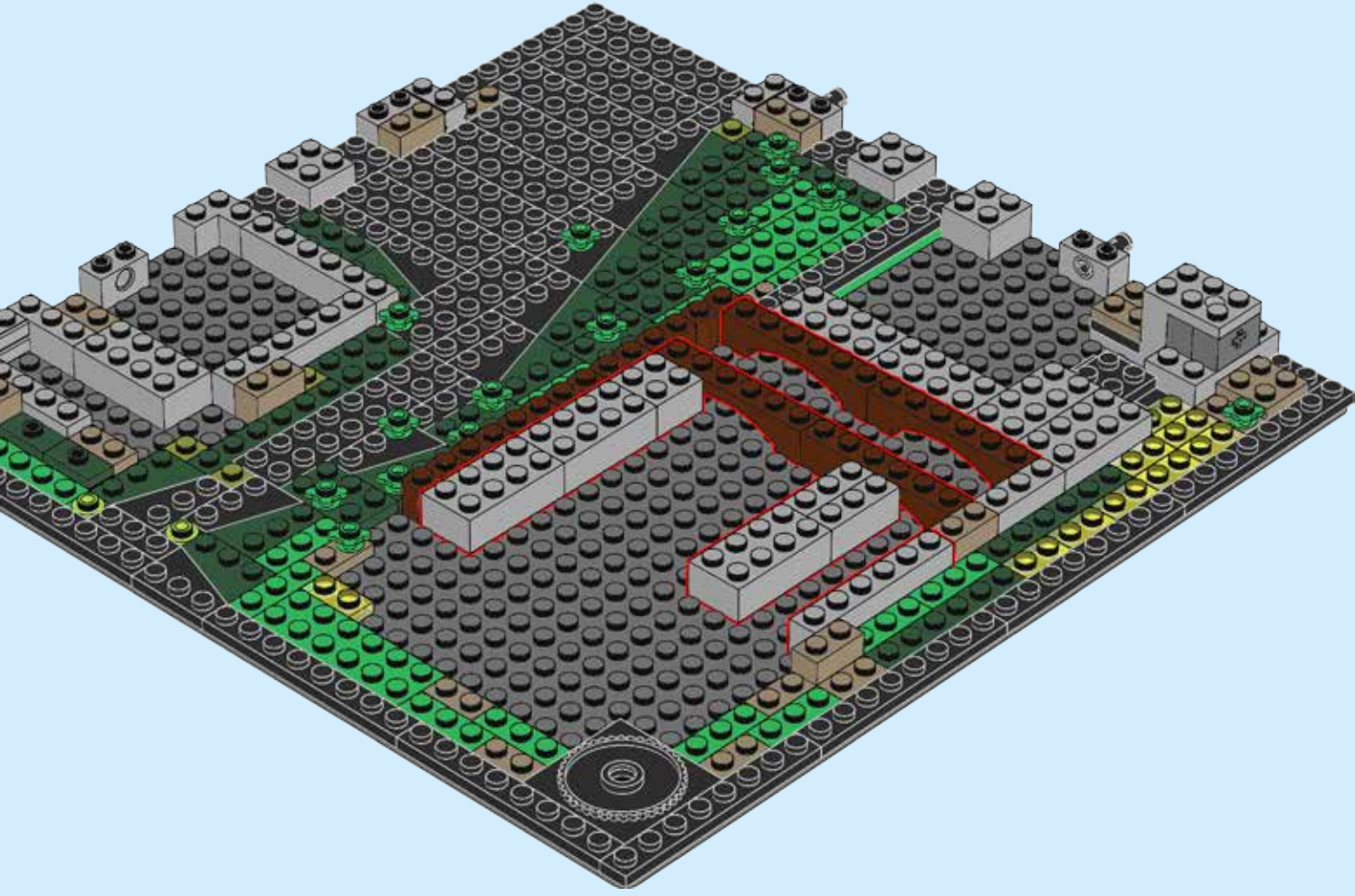



27

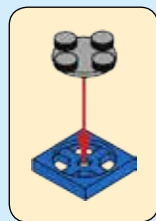

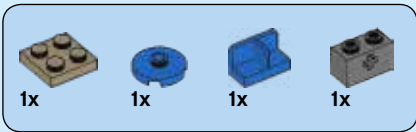

28

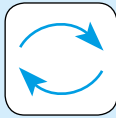
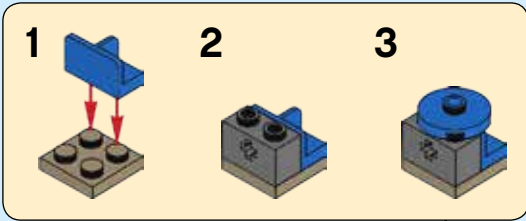

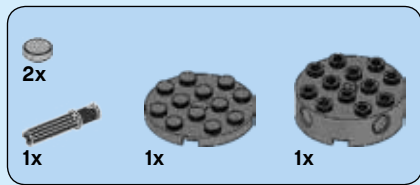

29

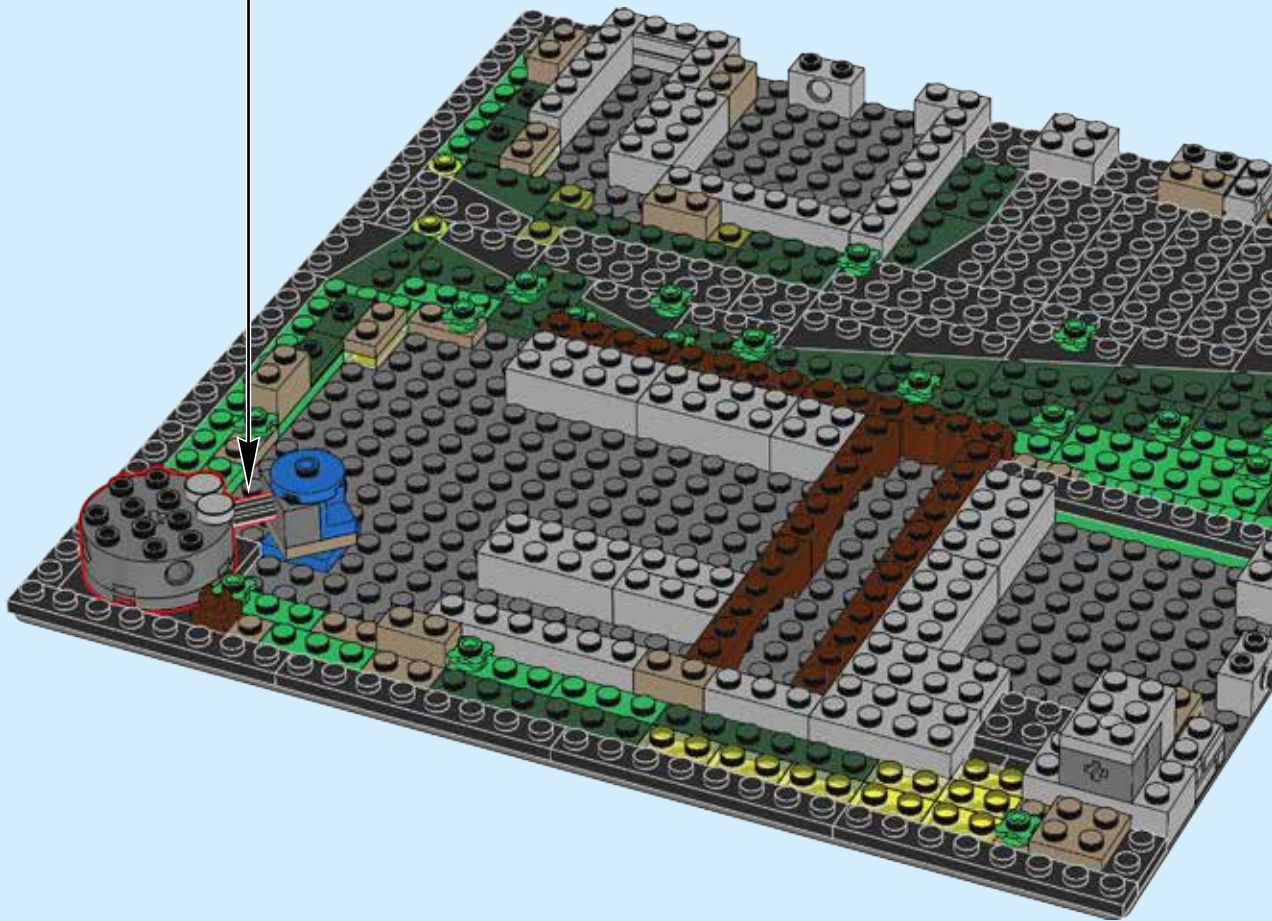
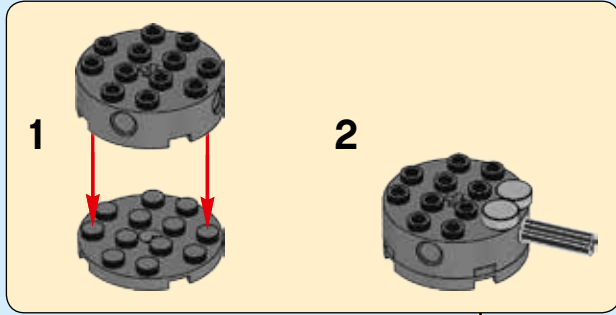

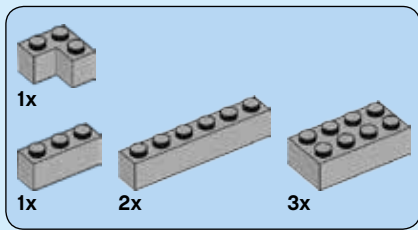

30

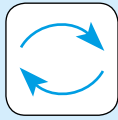

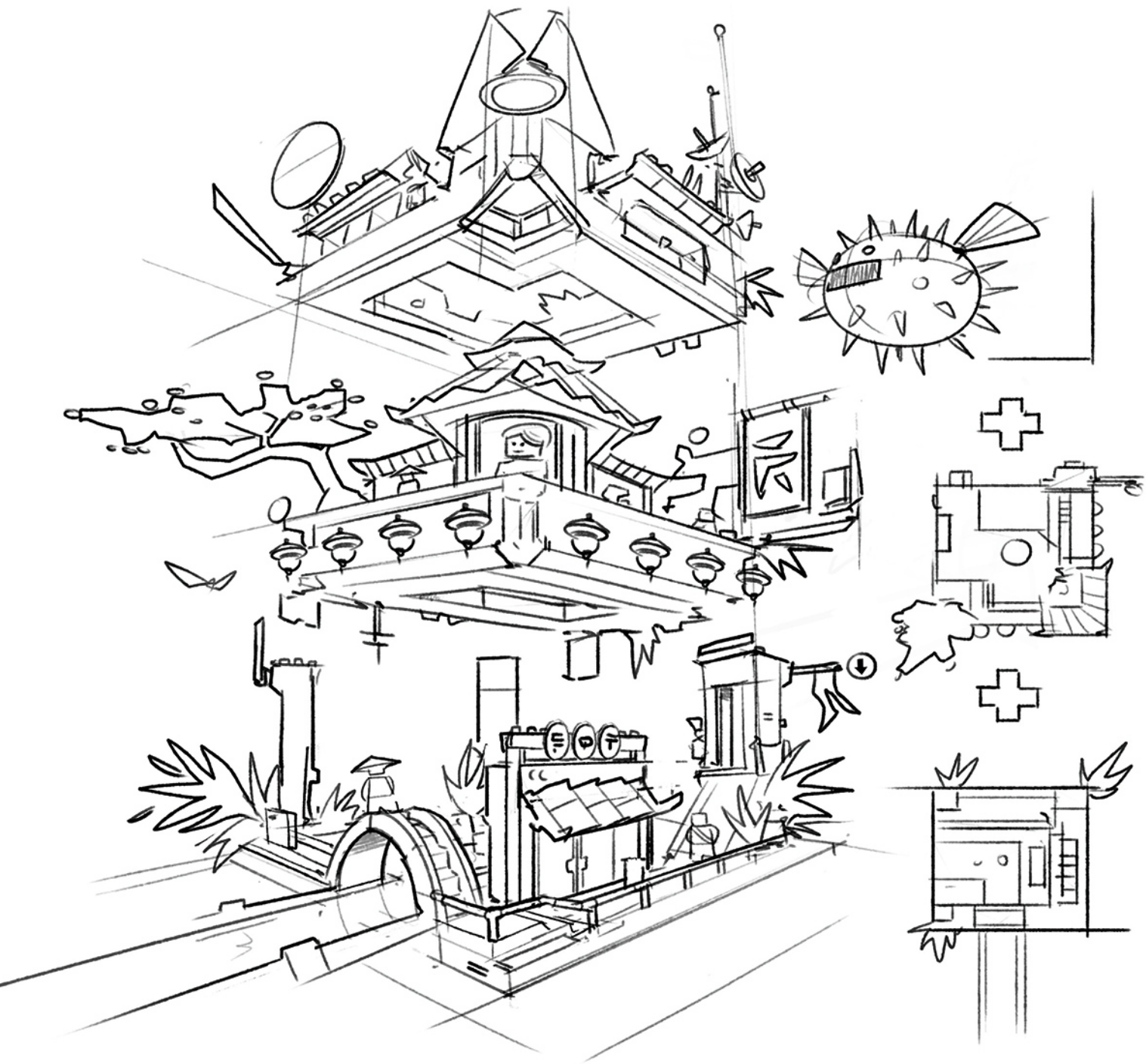

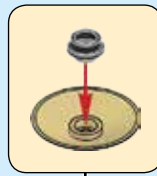

31

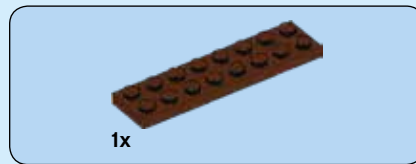

32





33



34

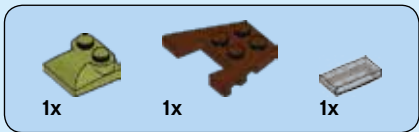

35



36



37

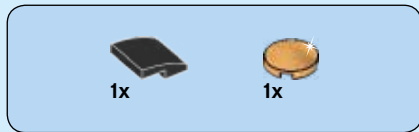

38



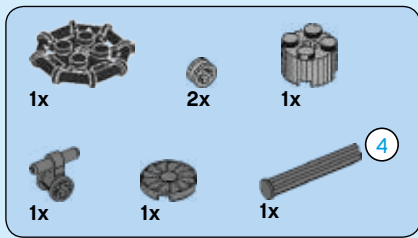

39

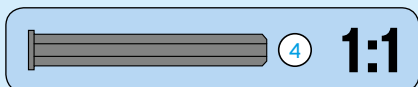
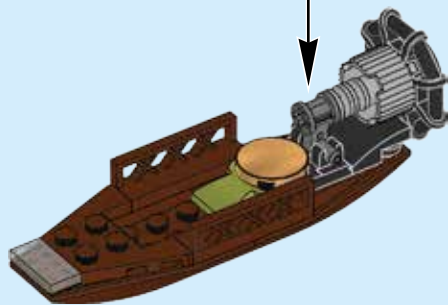
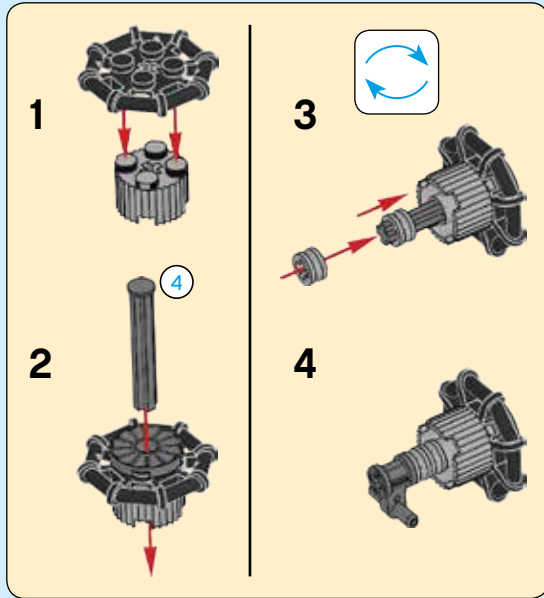

40

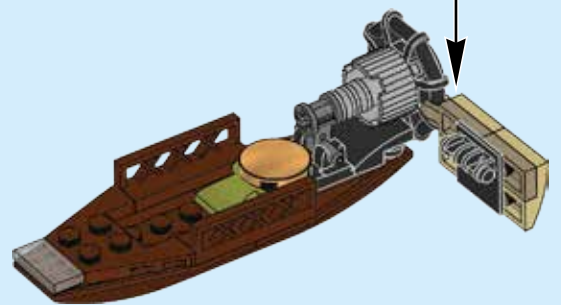
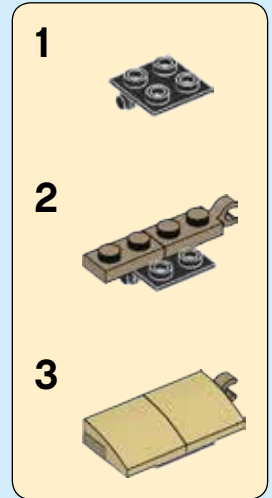

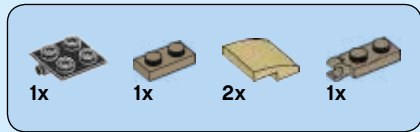

41

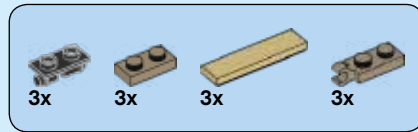
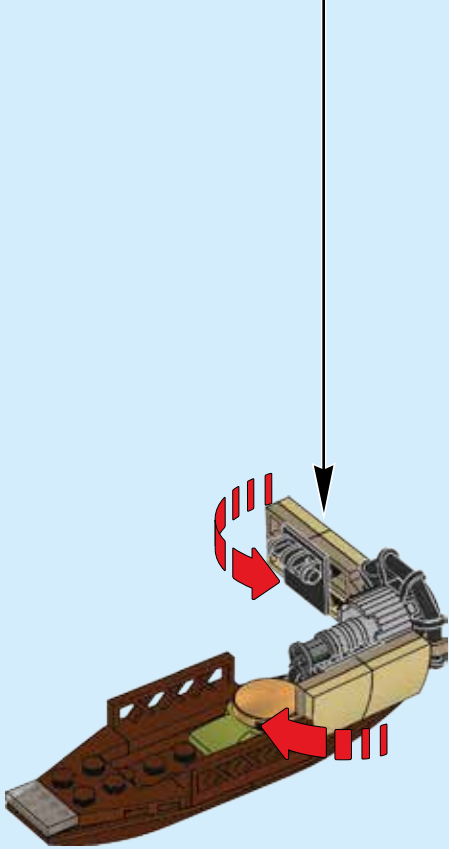
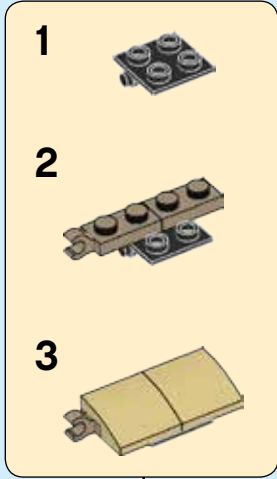

42

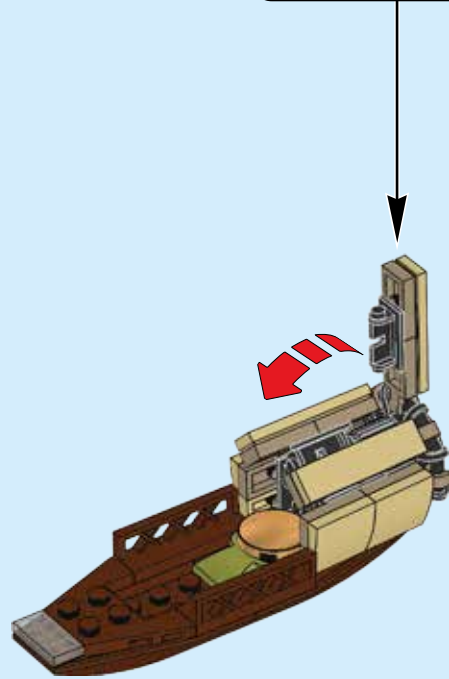
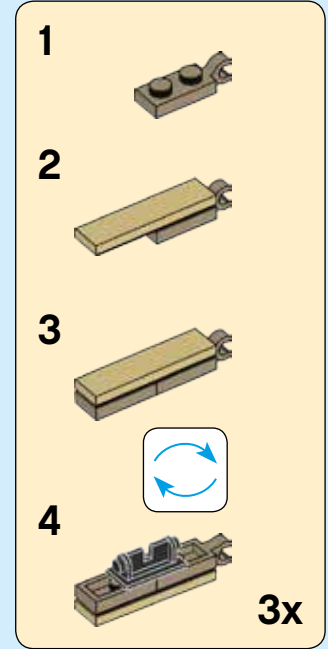



21x



2x

43

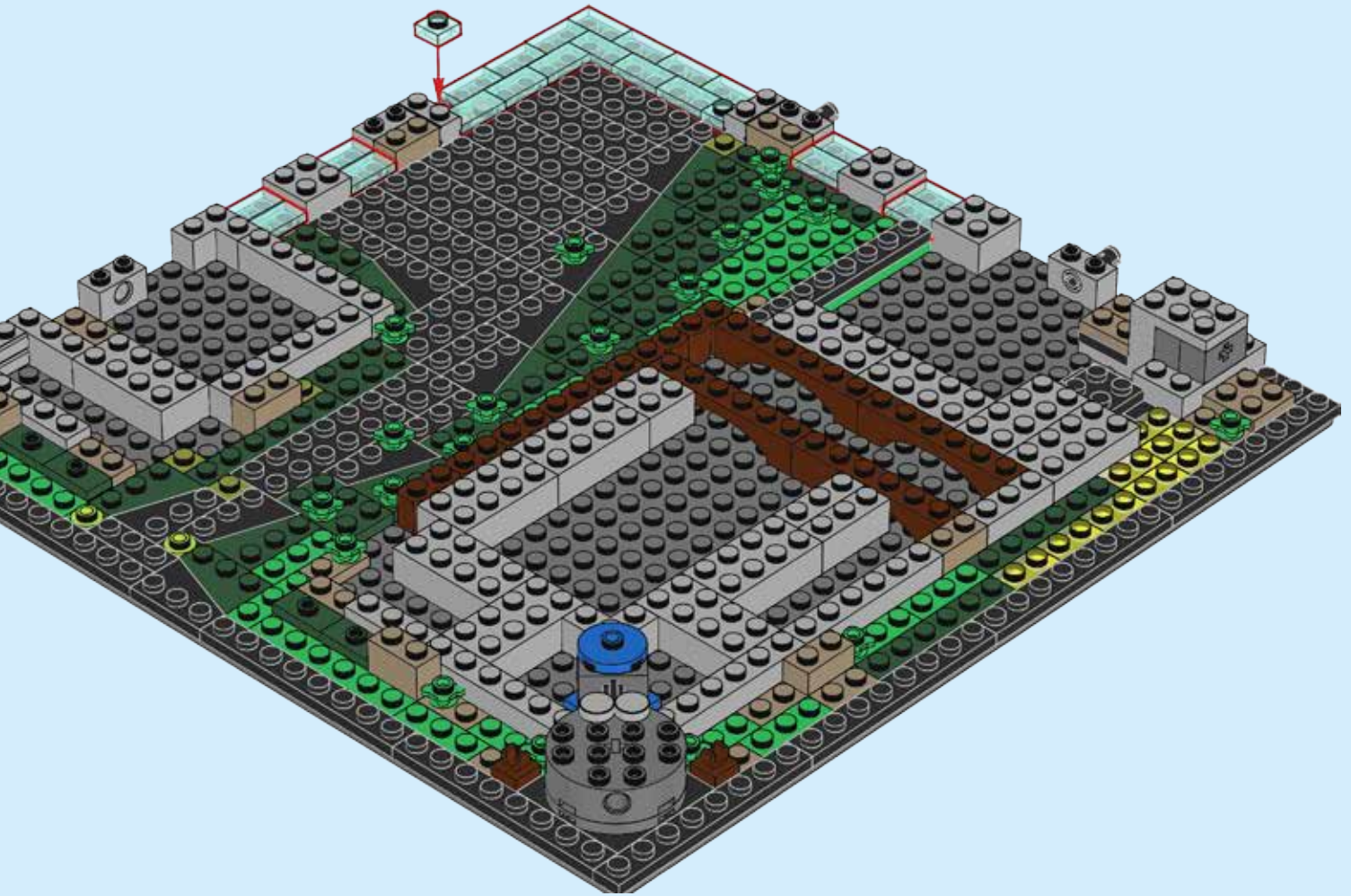



71x



3x

44





59x



8x

45

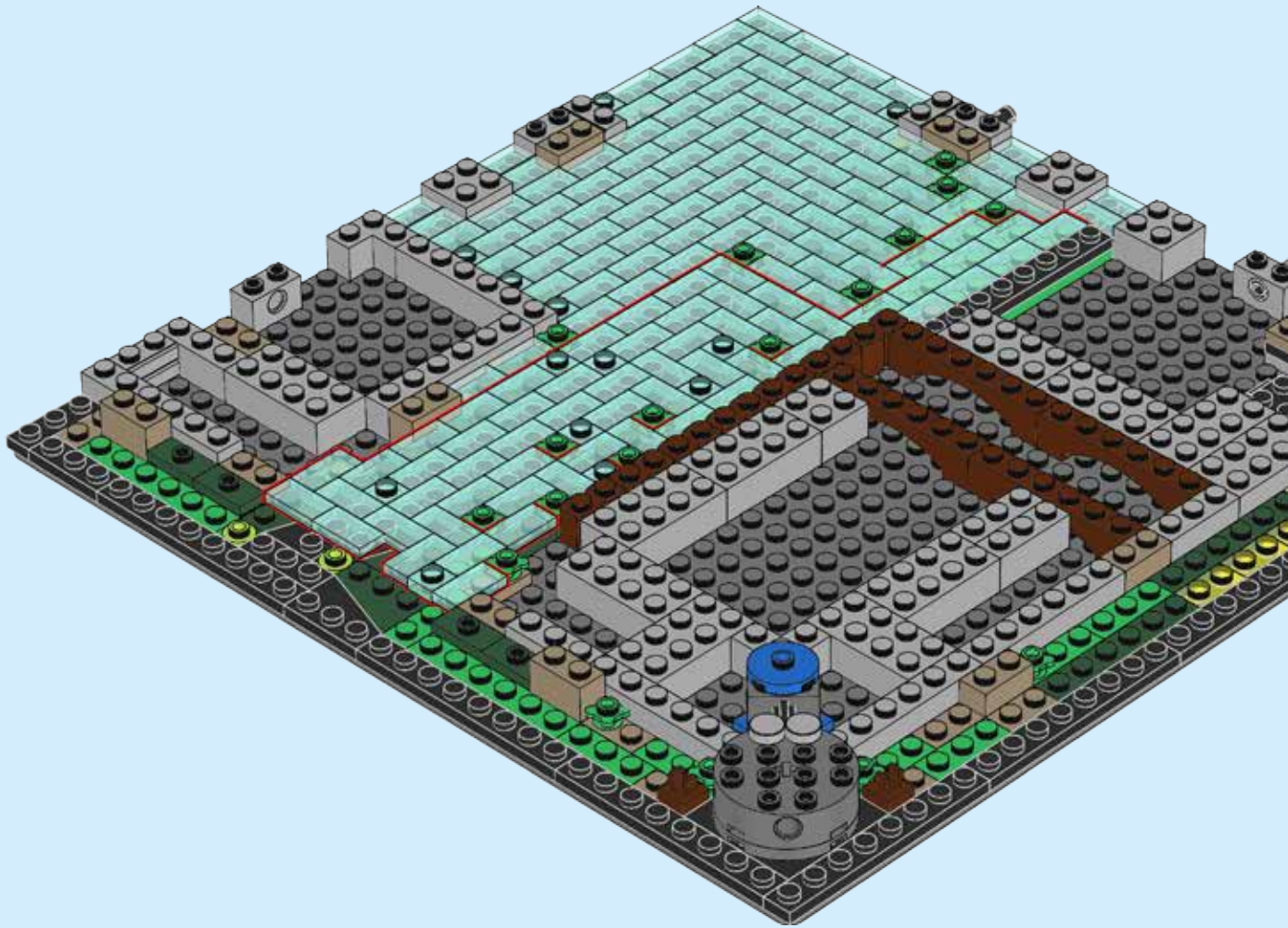



32x



6x

46

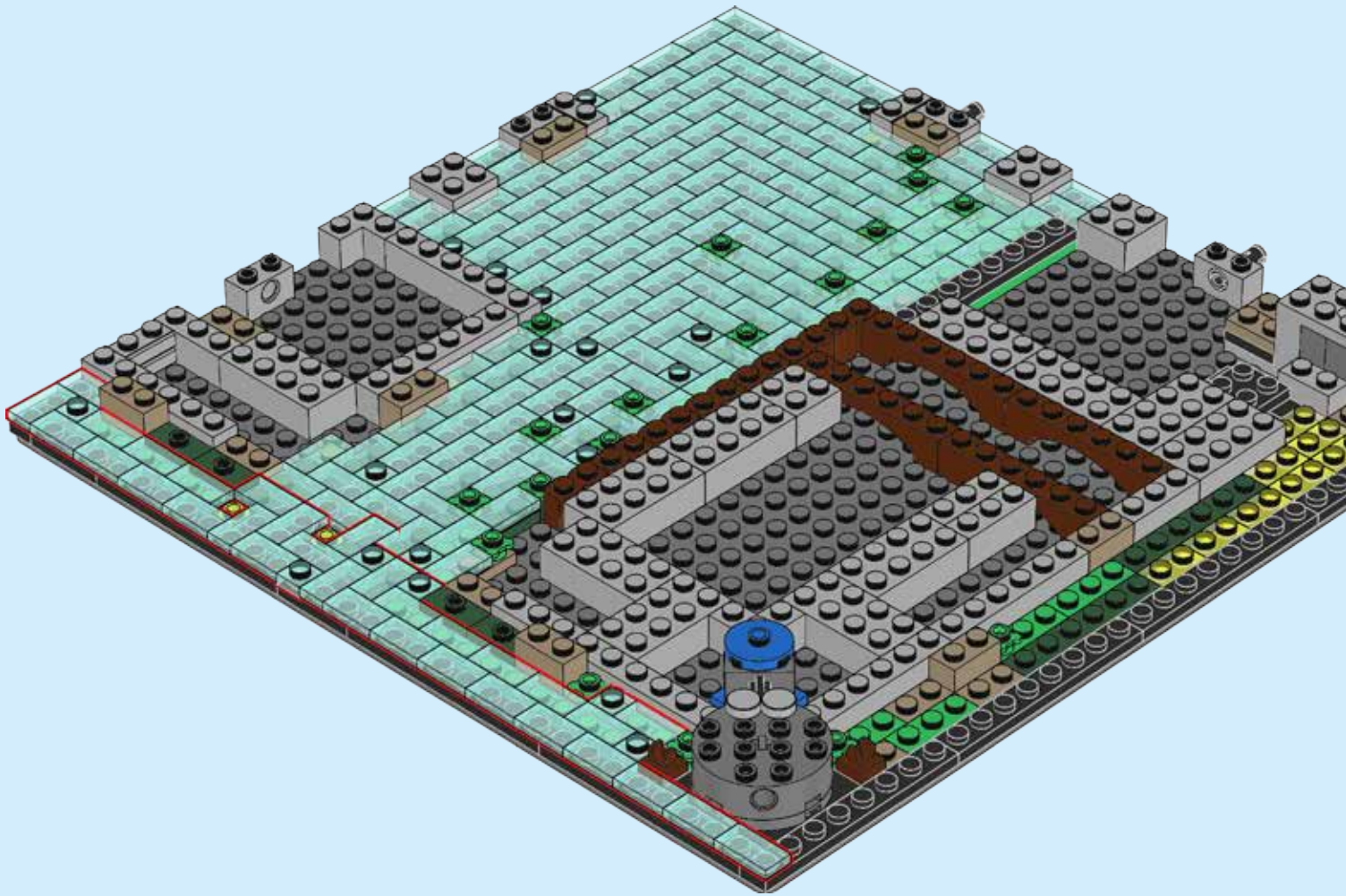



47

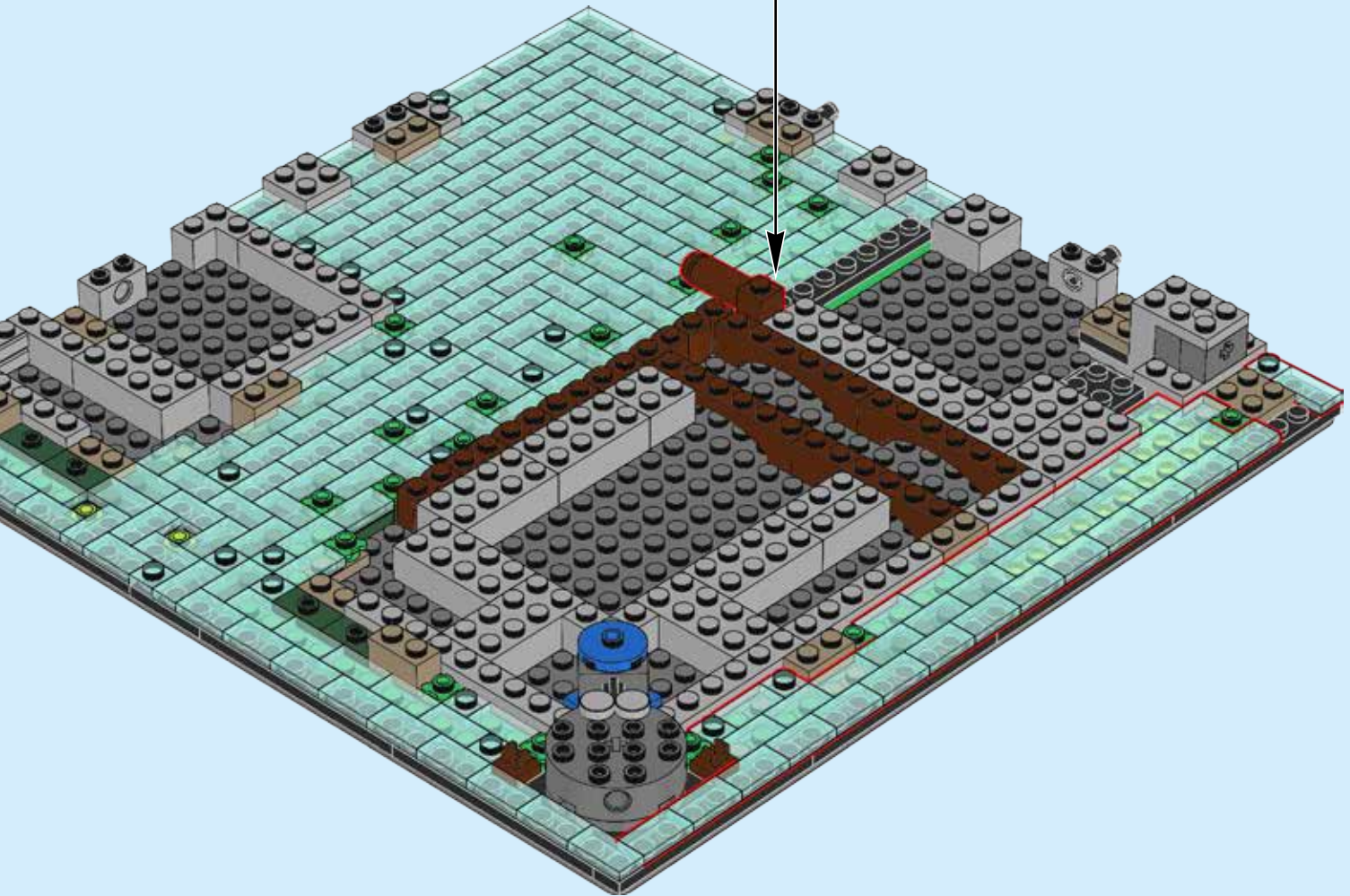
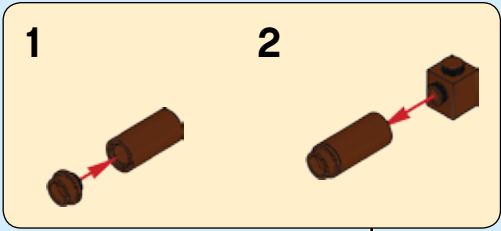



48

1

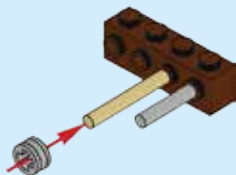

2

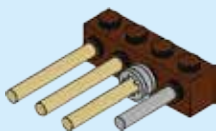

3

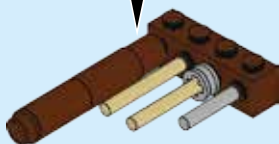

1



2



4



1



2



5

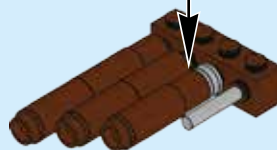

1



2



6





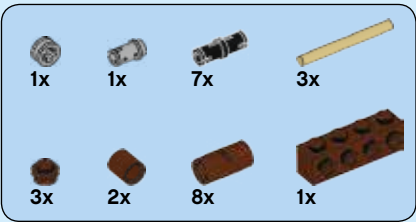

49

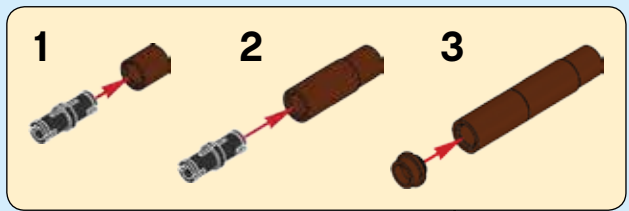
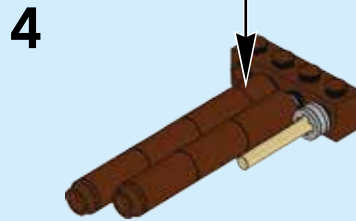
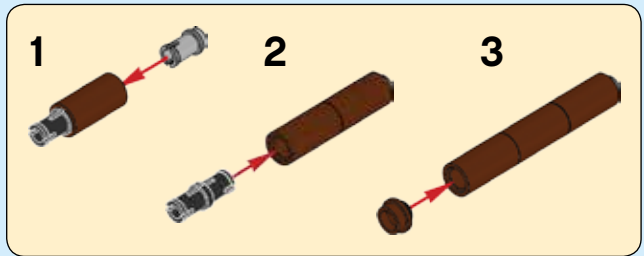
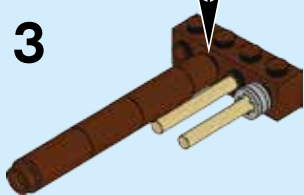
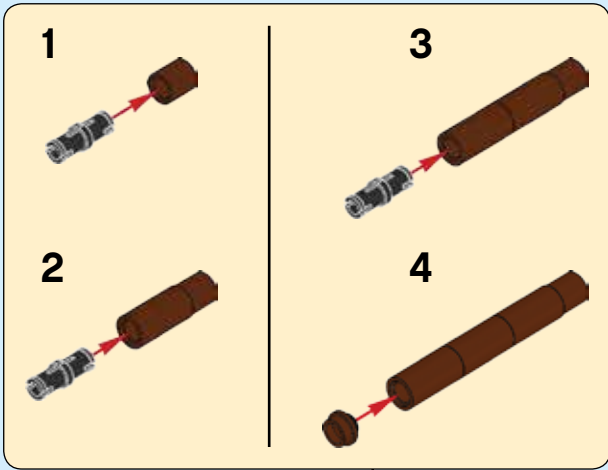
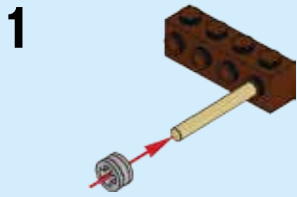





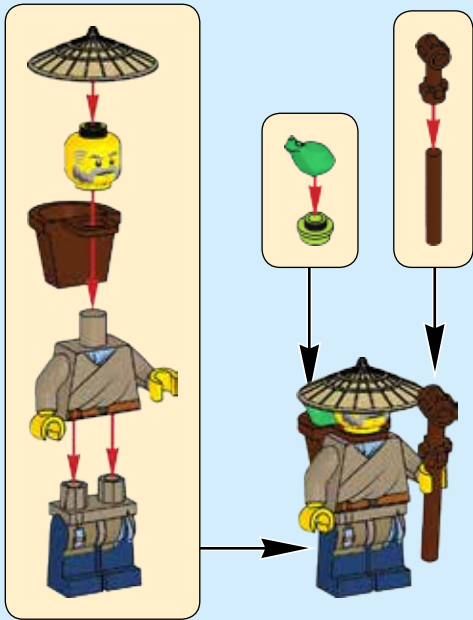
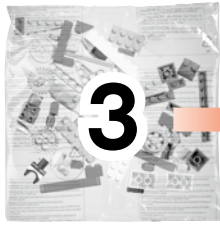

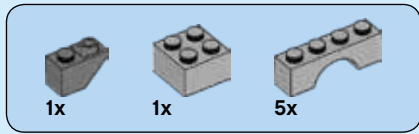

50



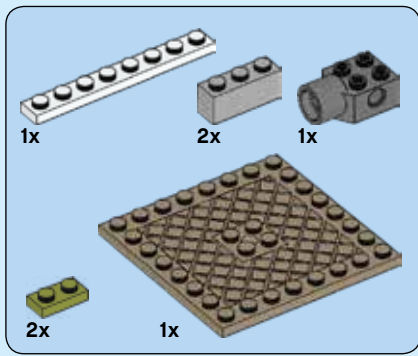

51

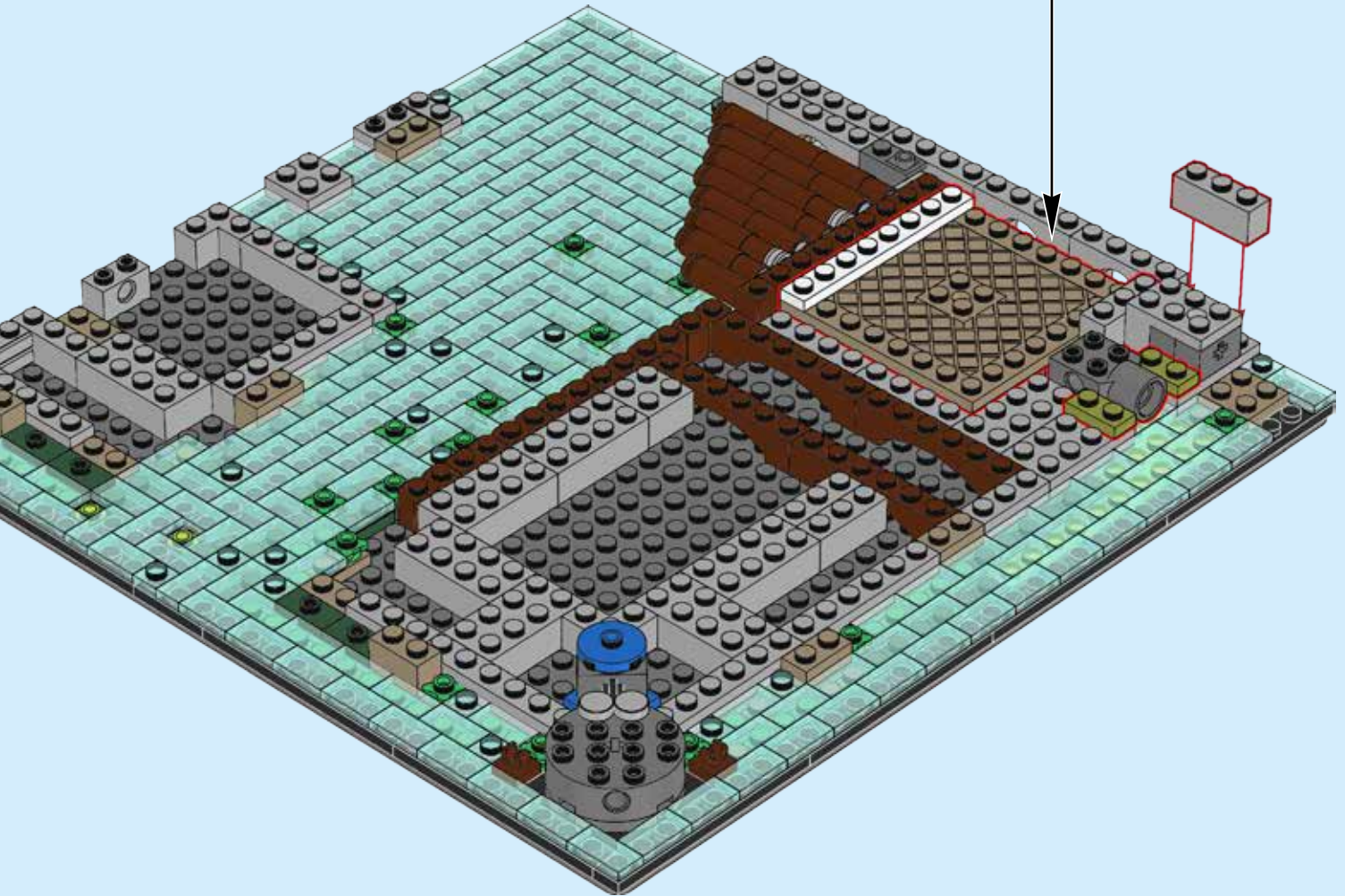
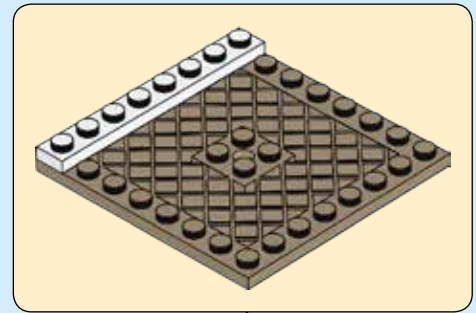

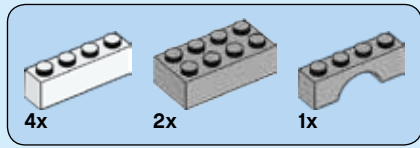

52



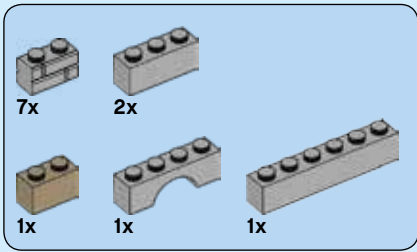

53



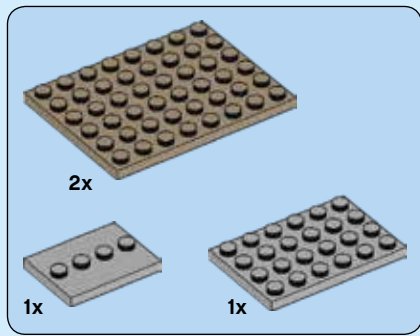

54

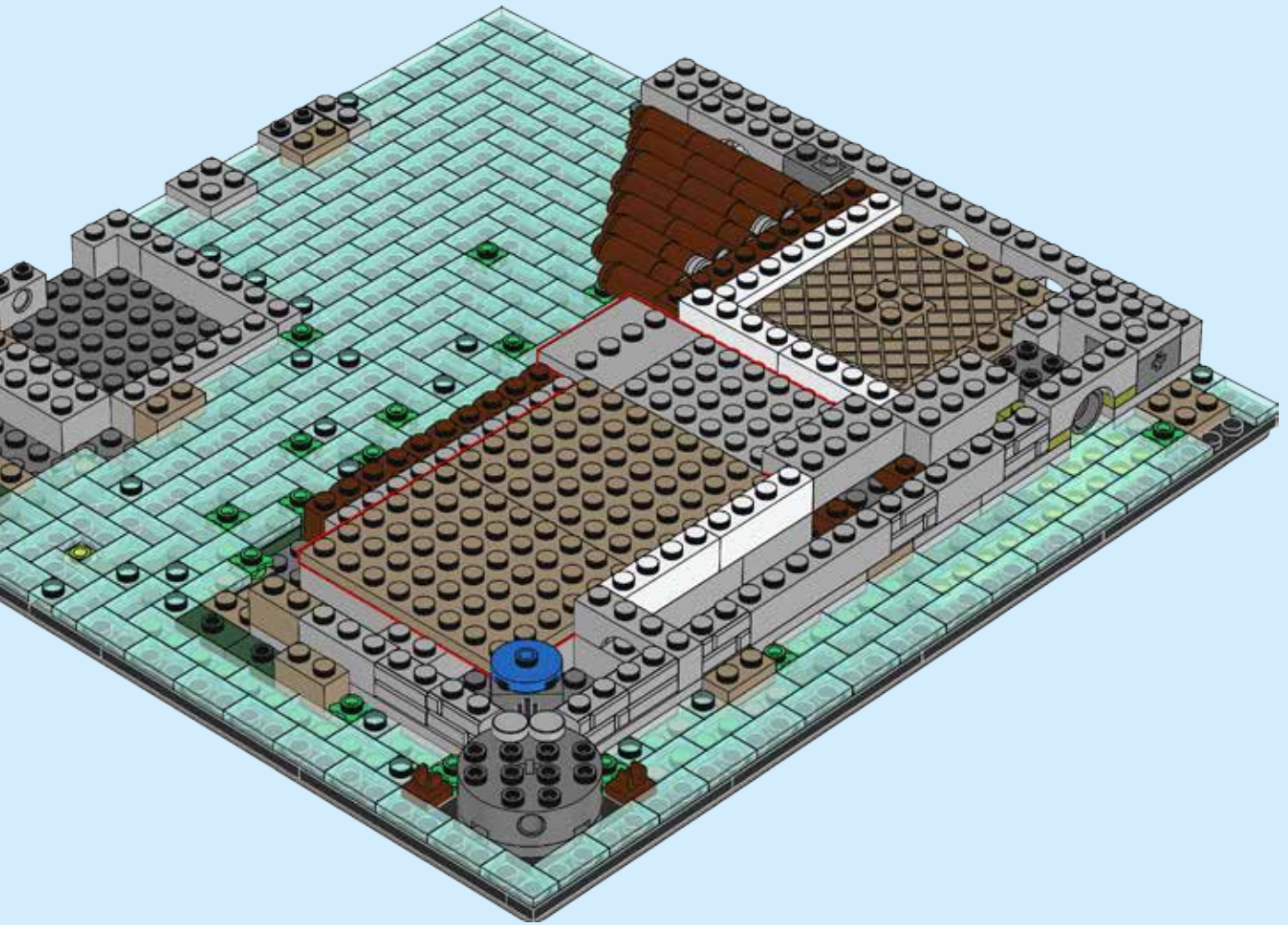

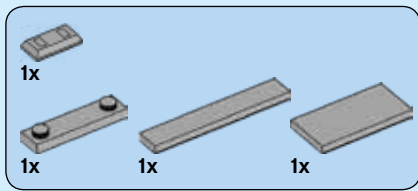

55



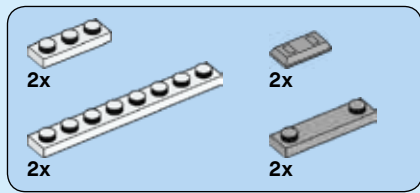

56

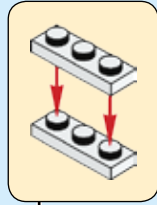
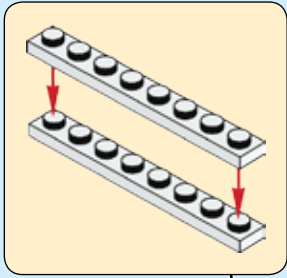

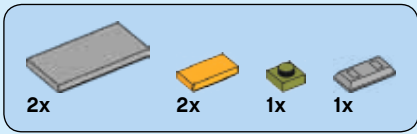

57



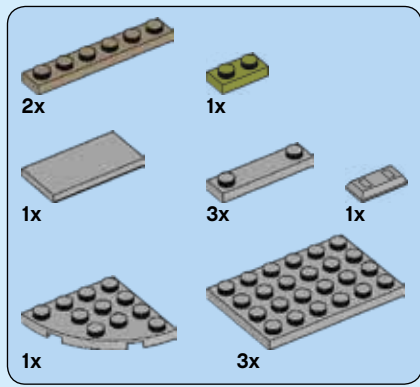

58

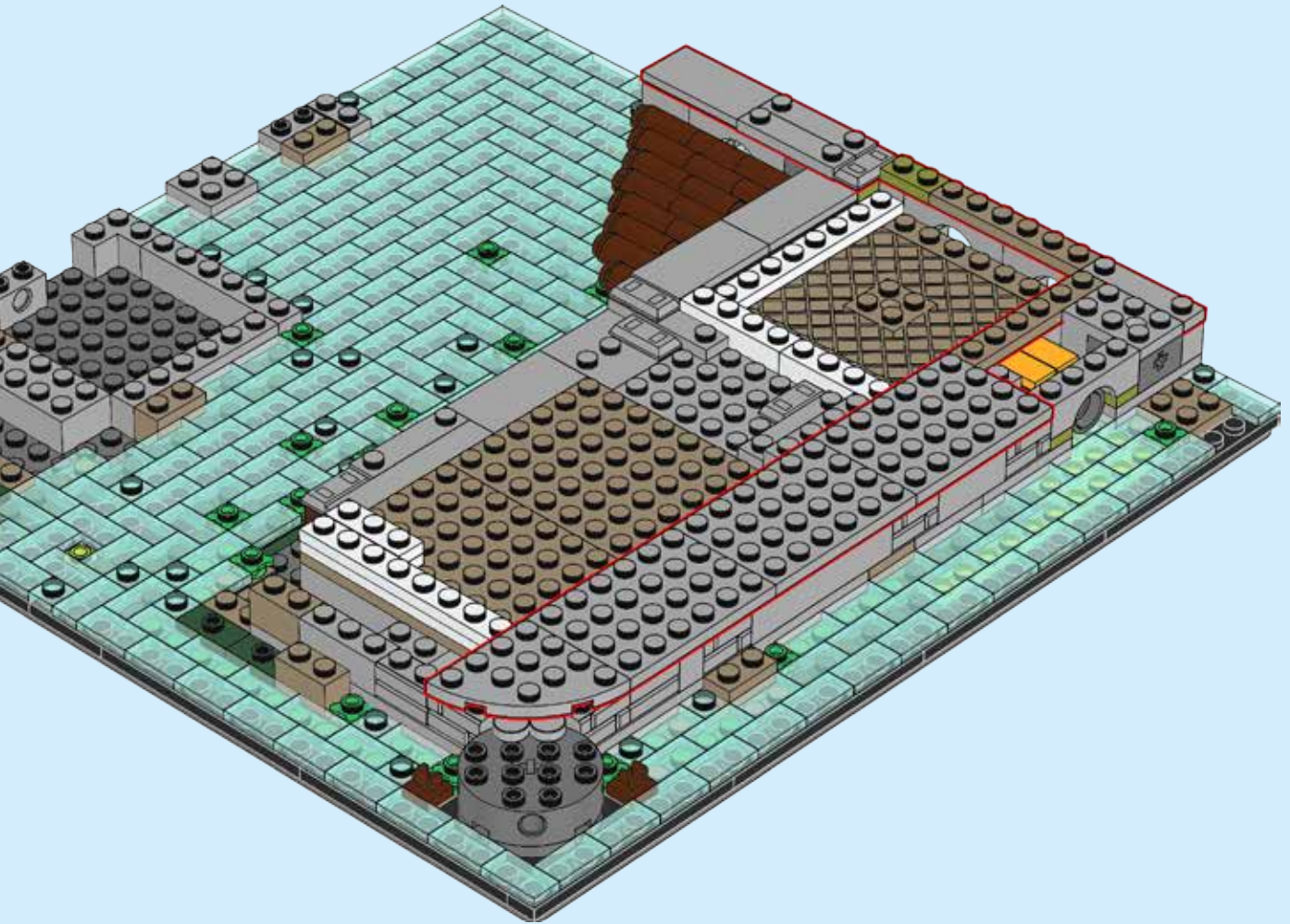

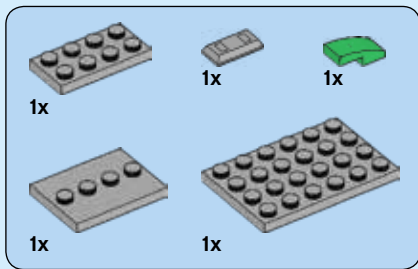

59

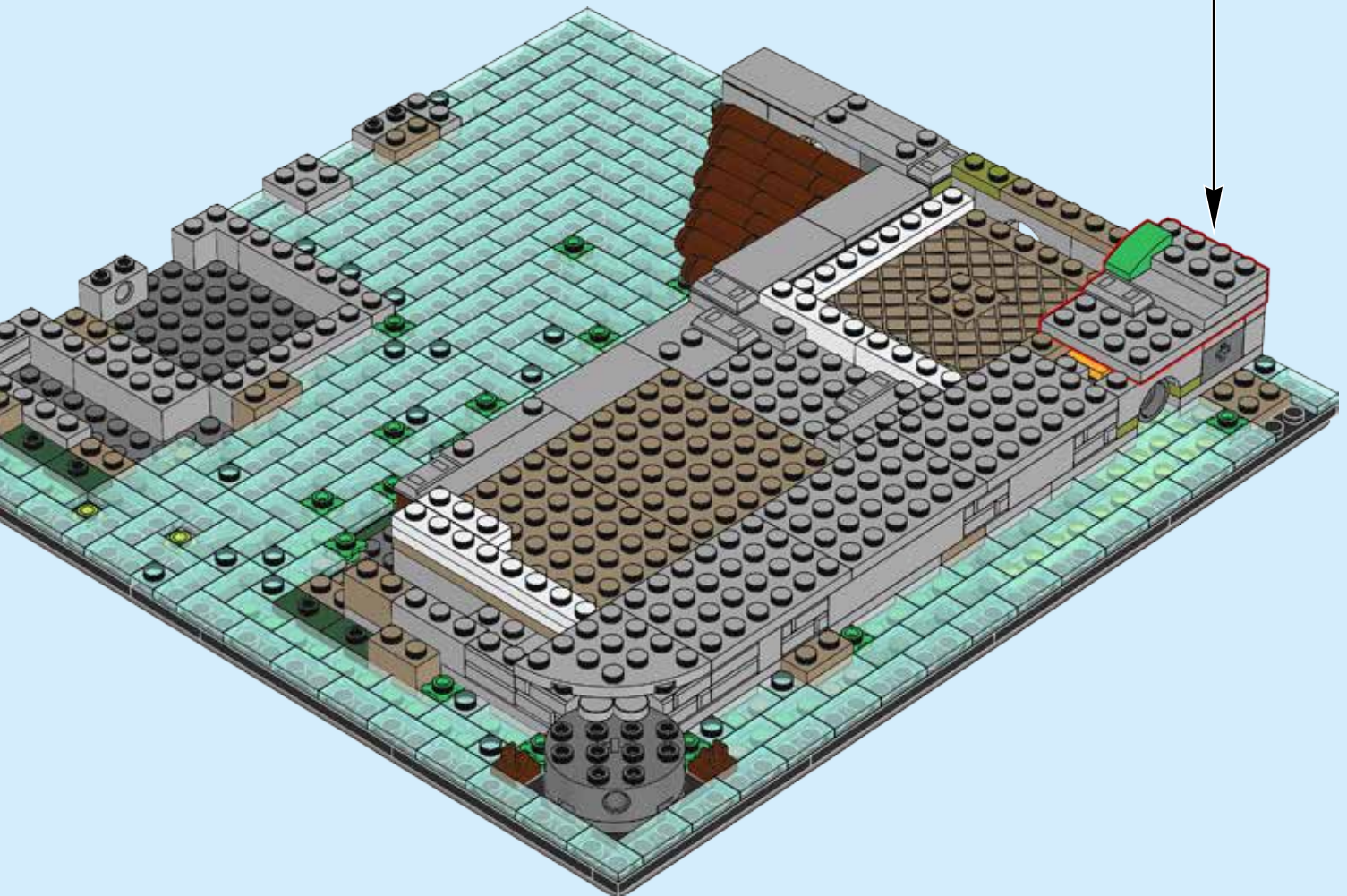
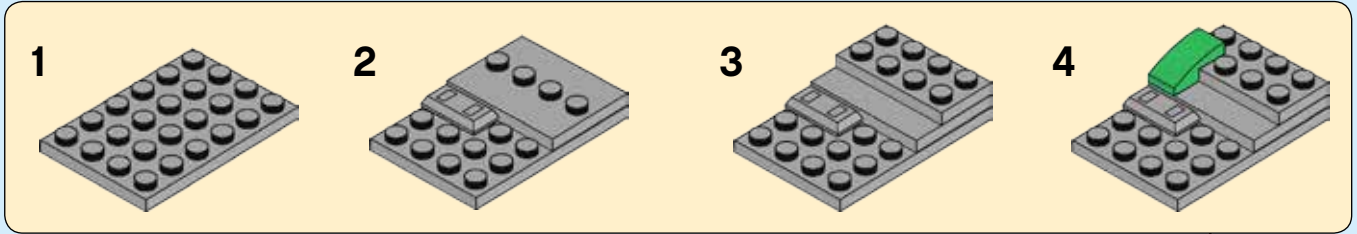

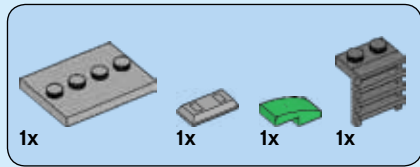

60

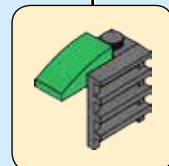

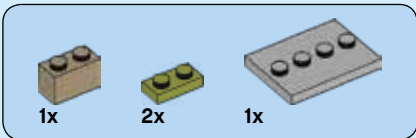

61

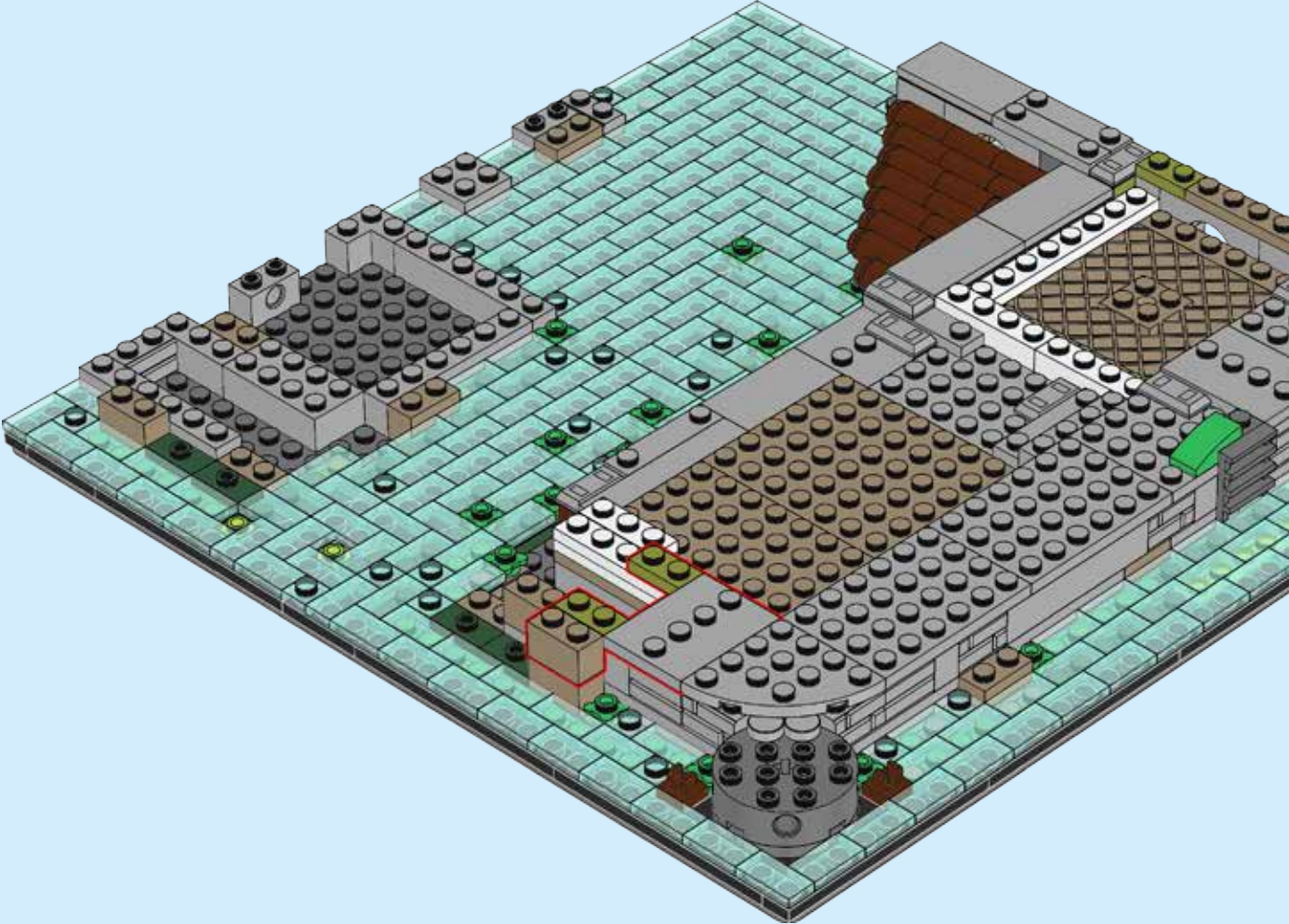

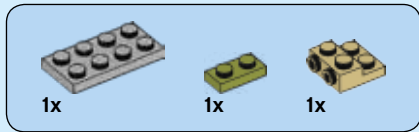

62

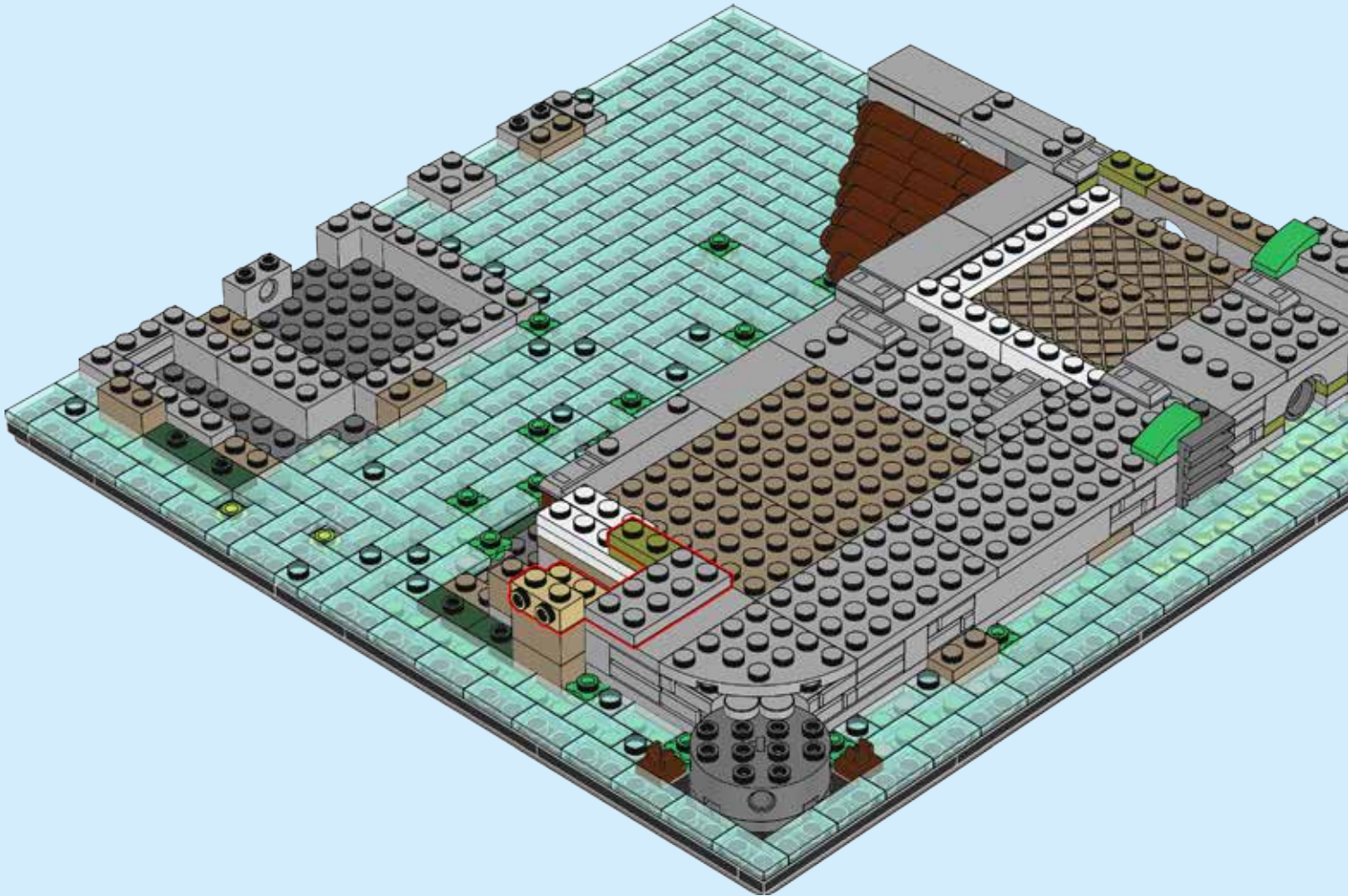

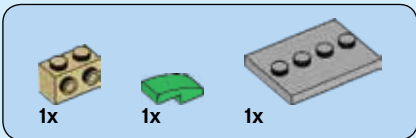

63



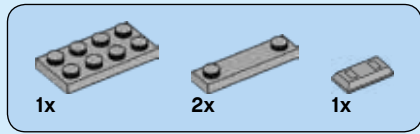

64

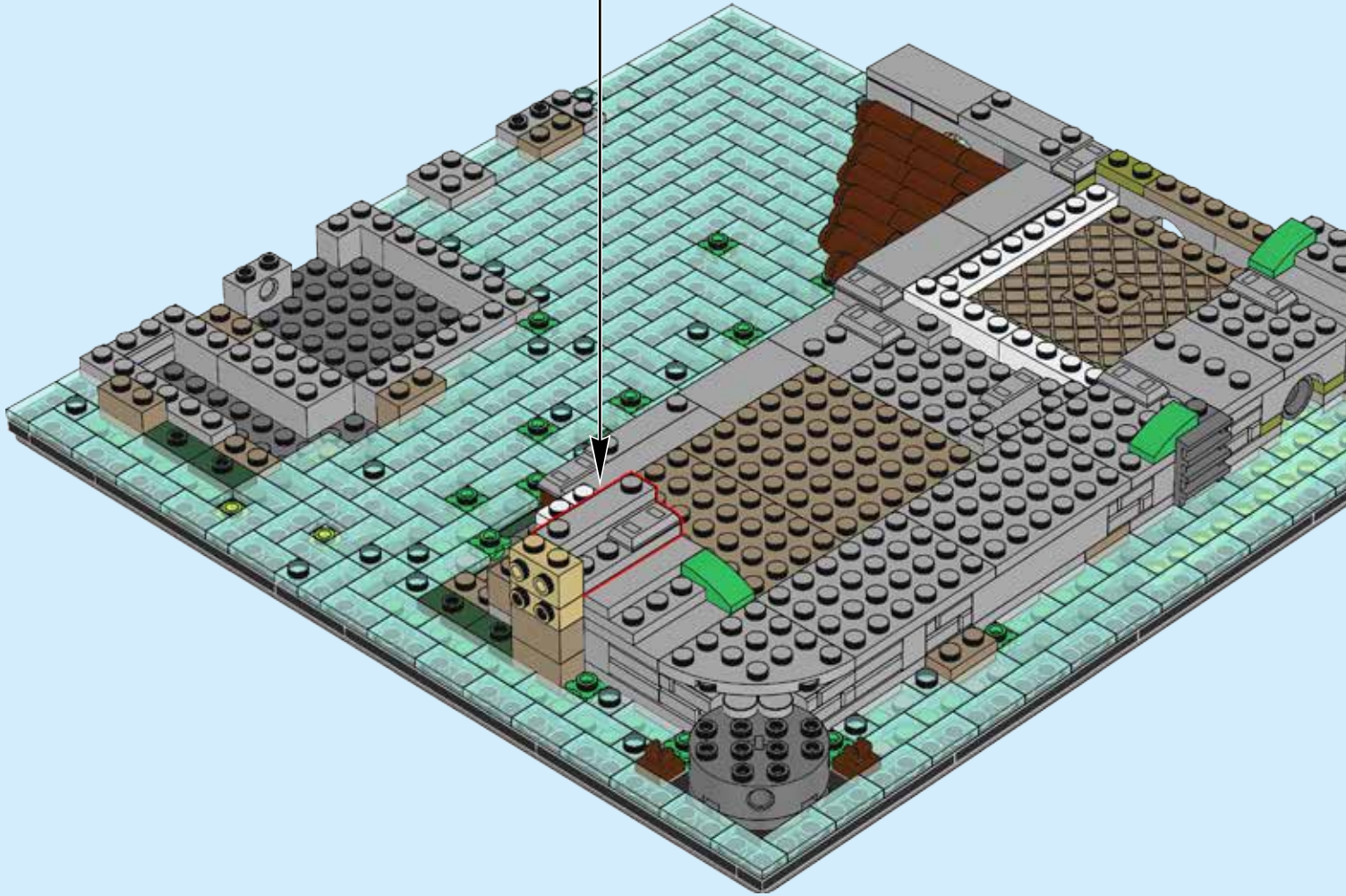
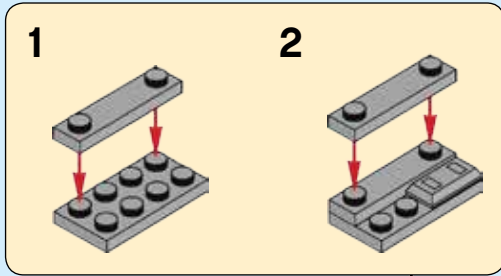

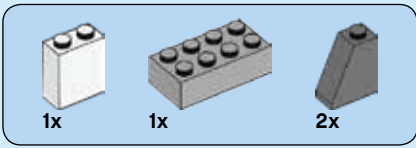

65

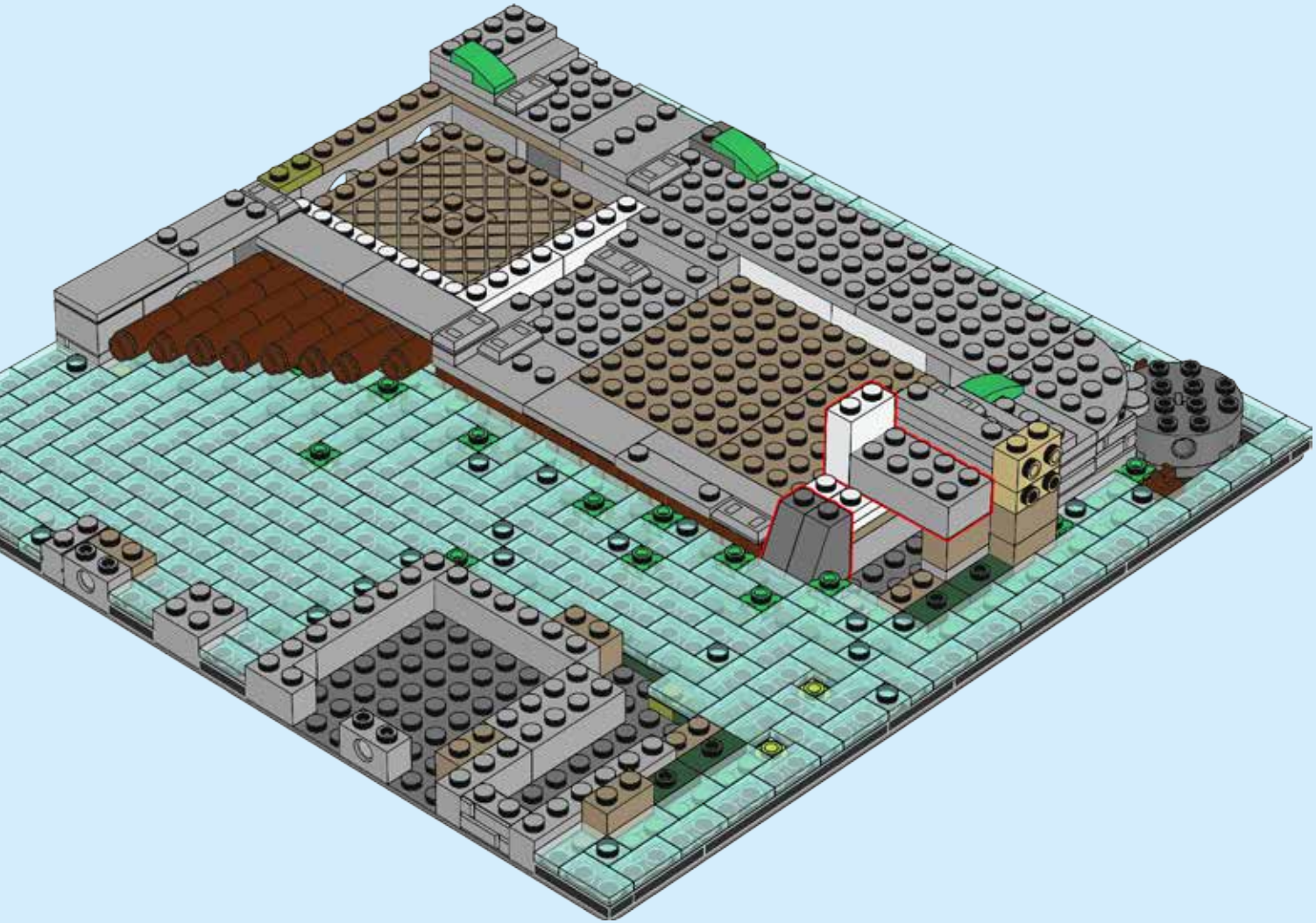
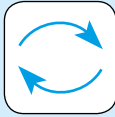

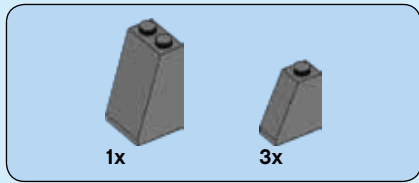

66

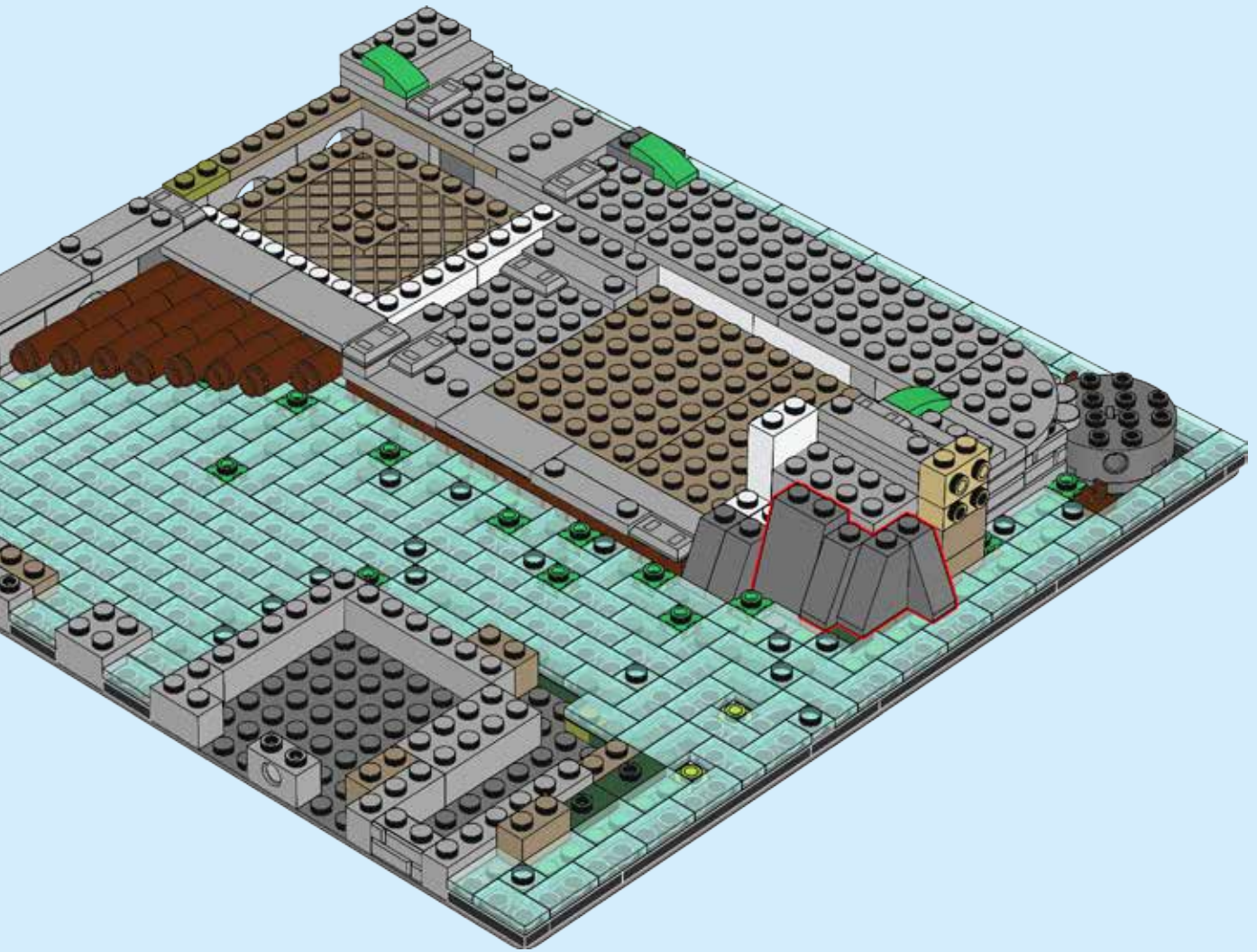

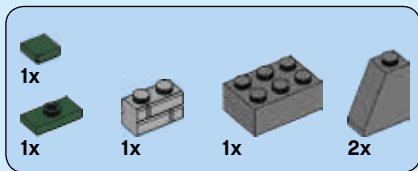

67



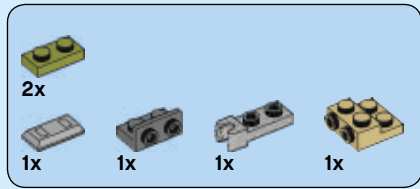

68

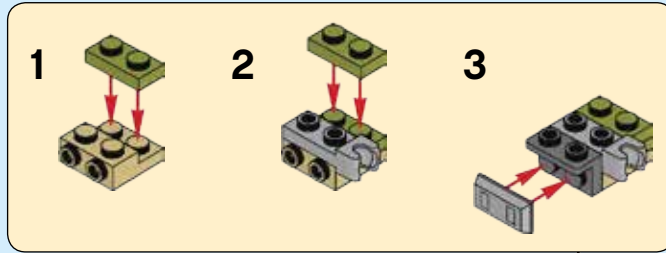

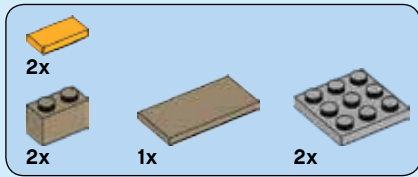

69

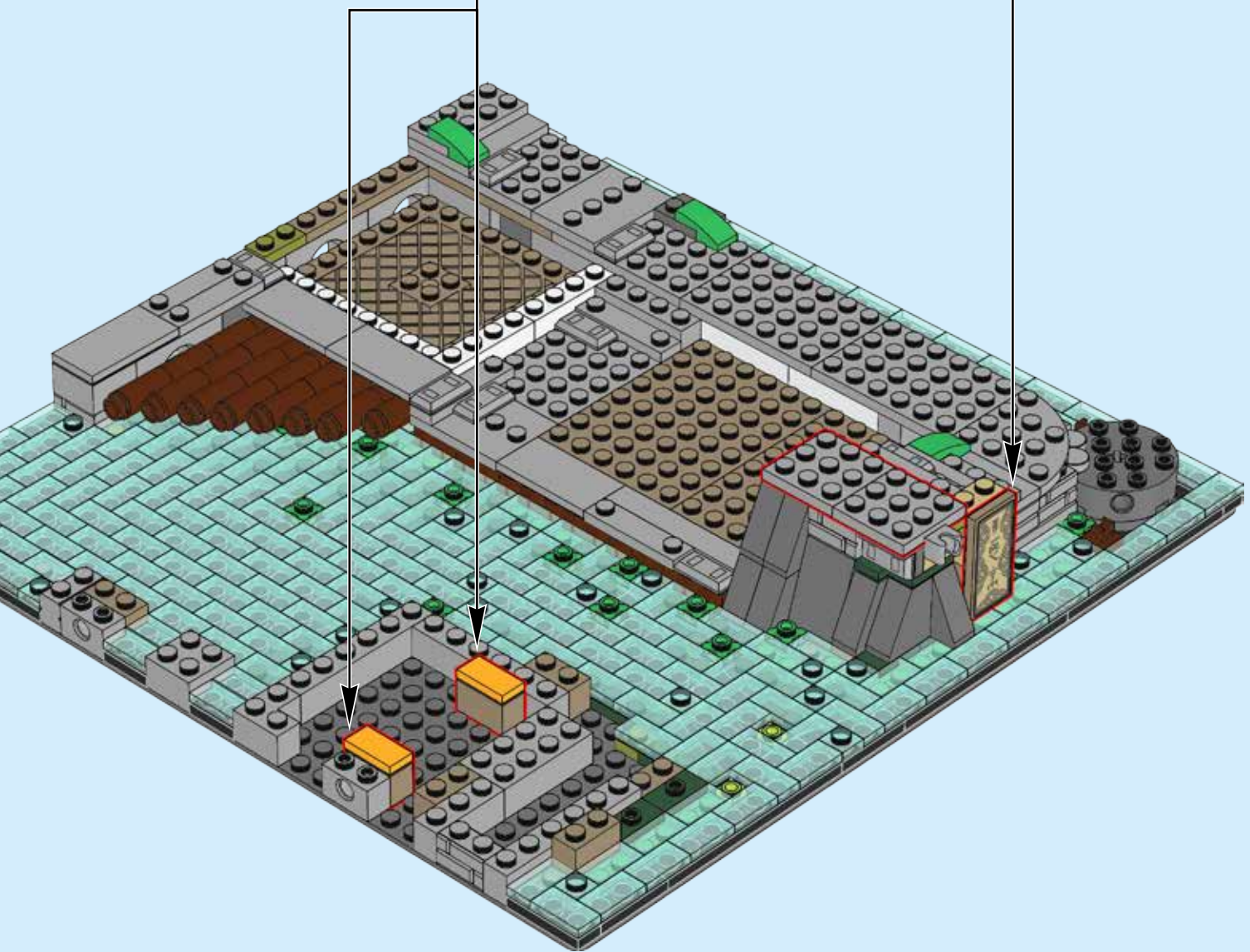
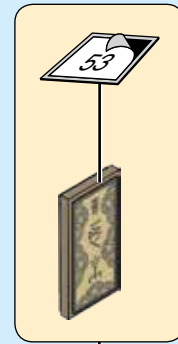
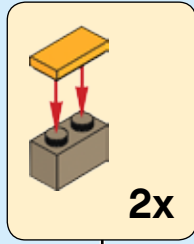

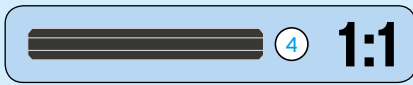
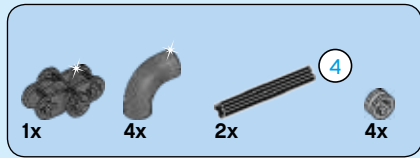

70

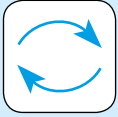
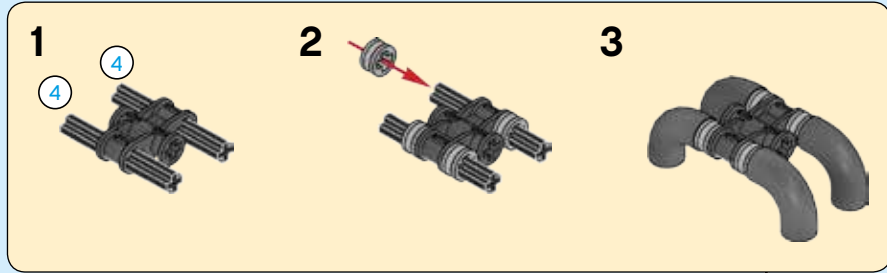

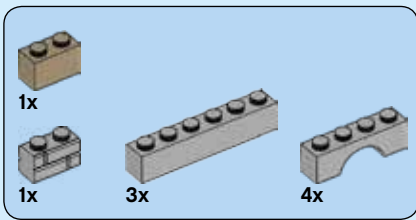

71

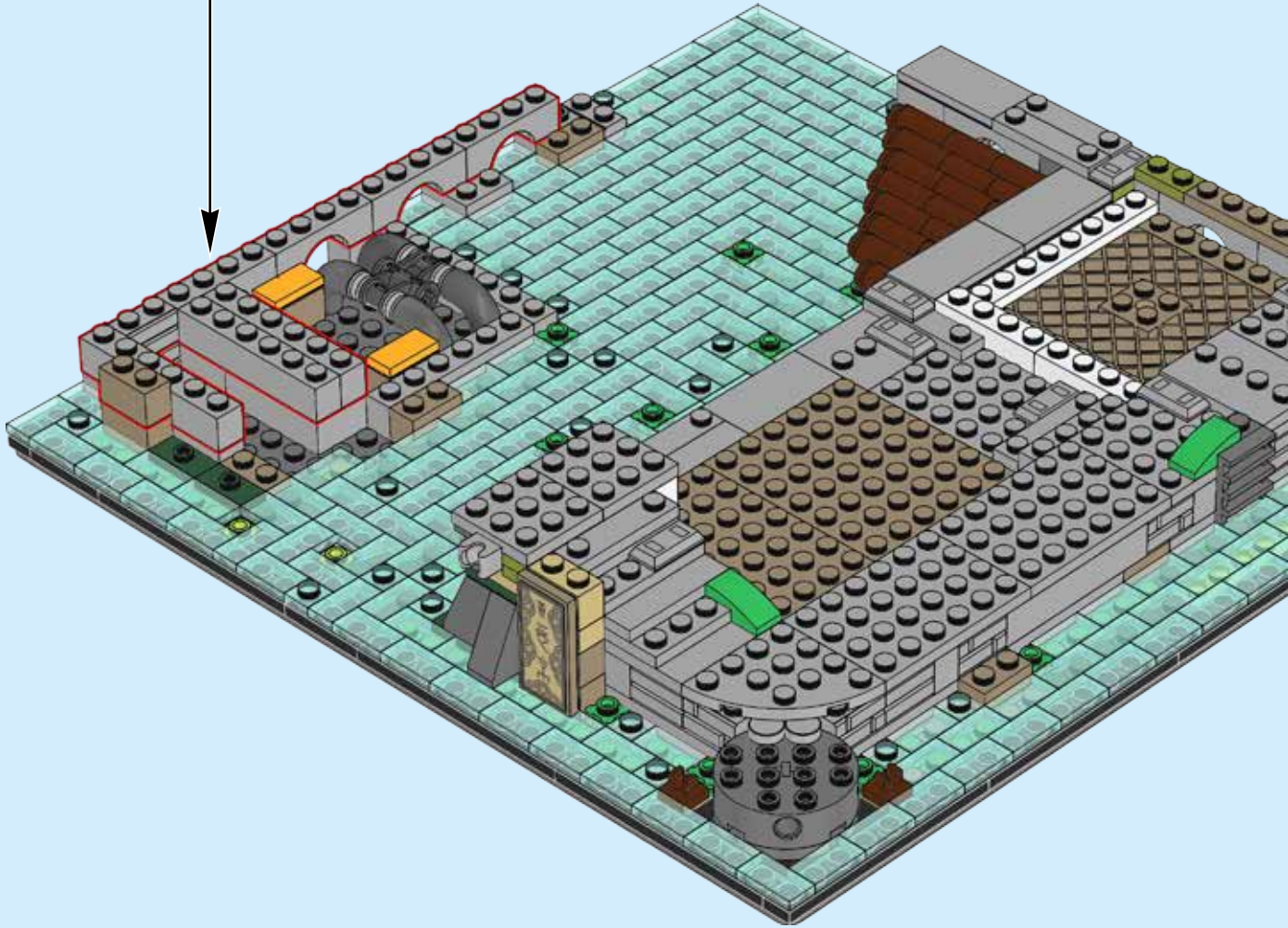
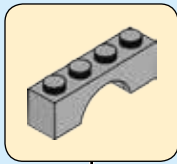

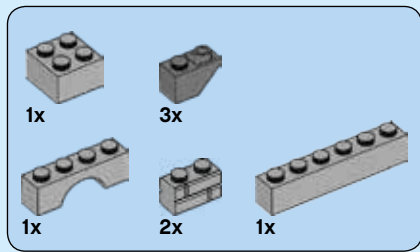

72

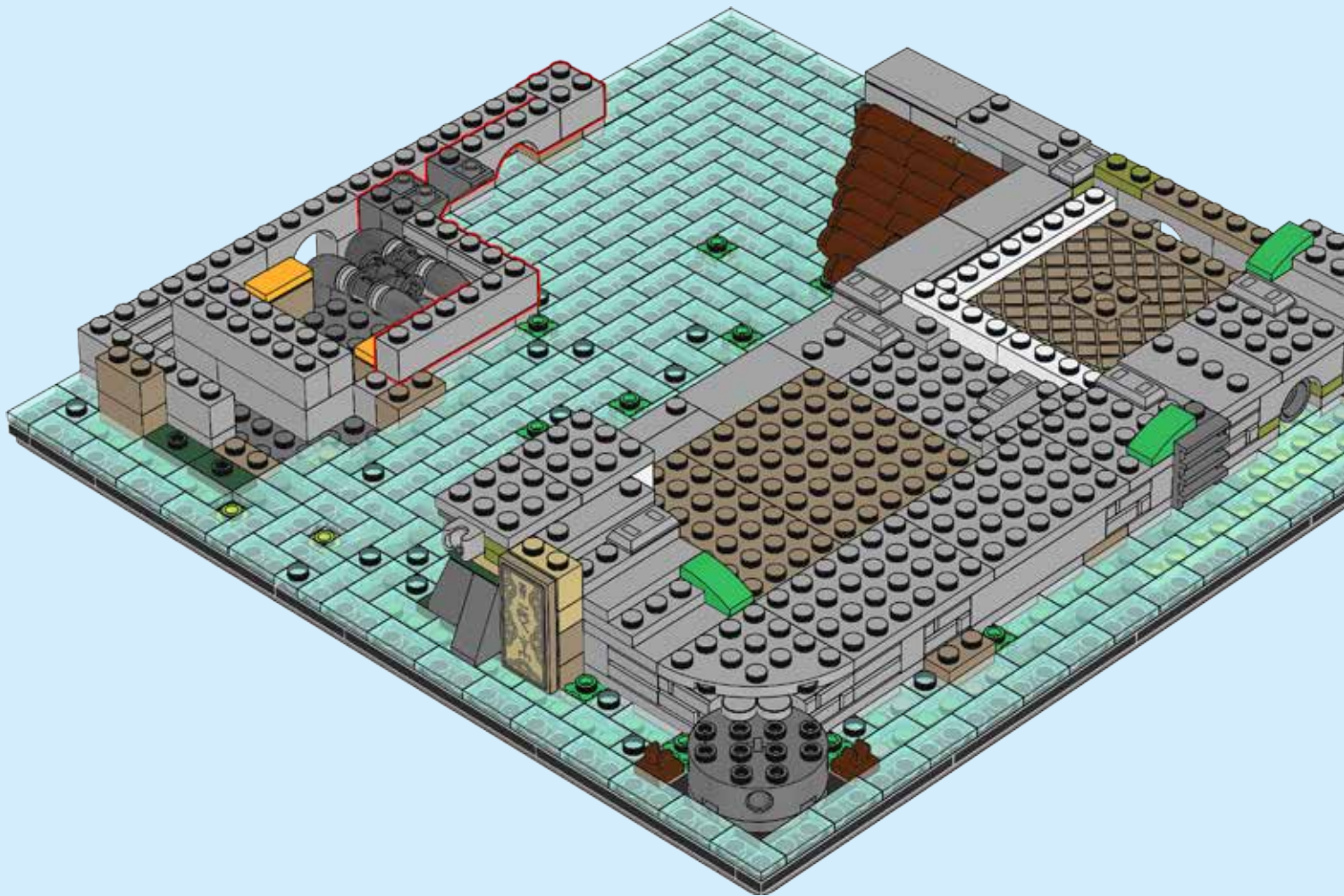

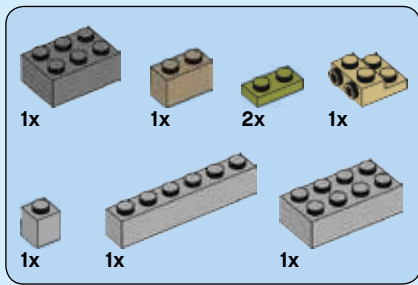

73

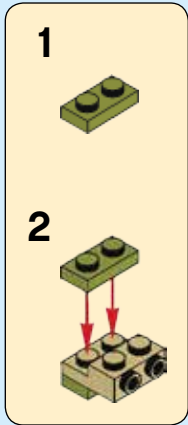

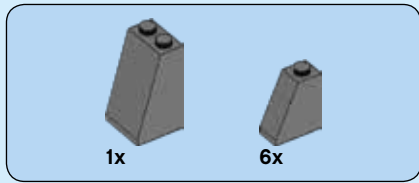

74

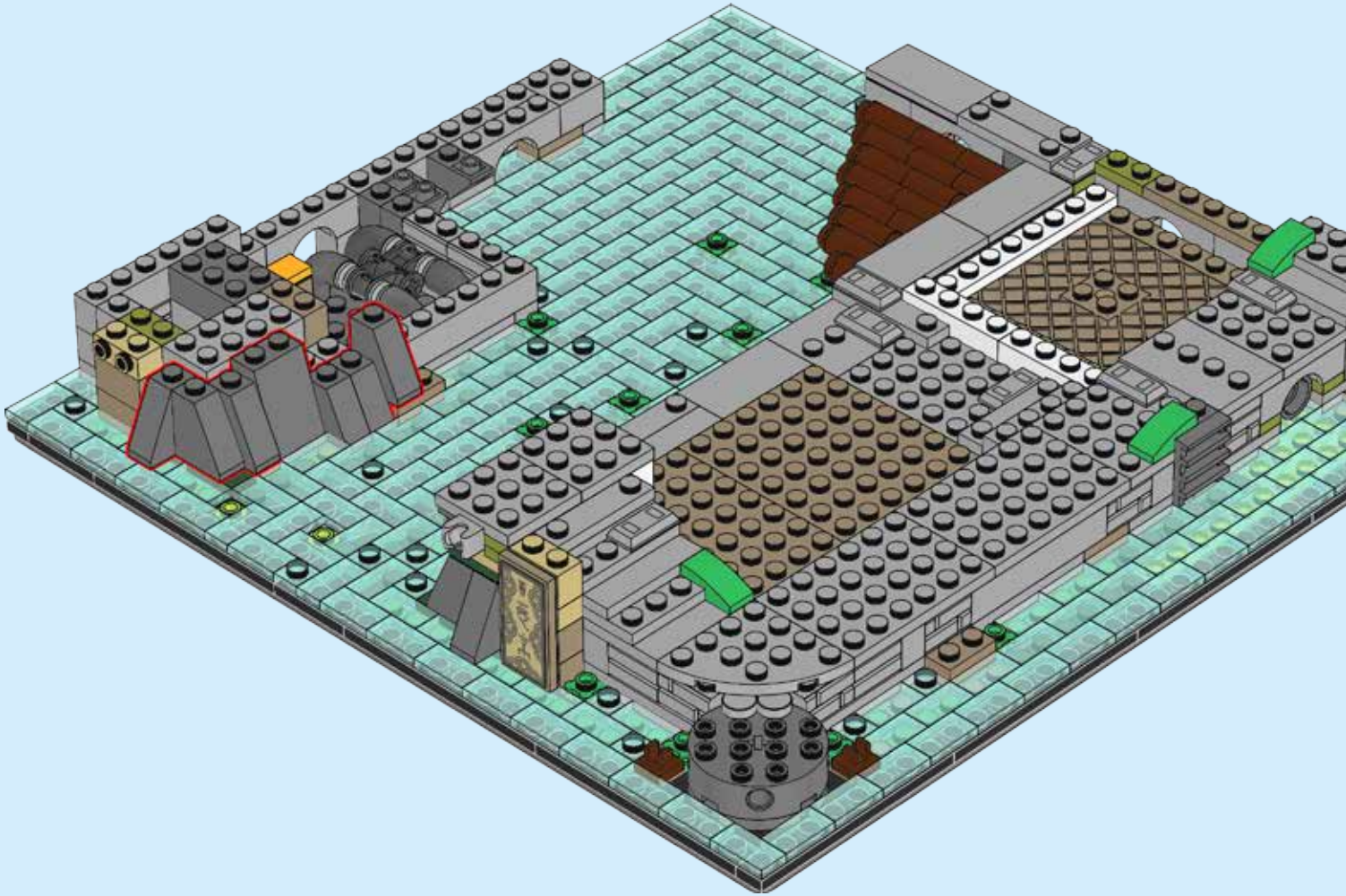

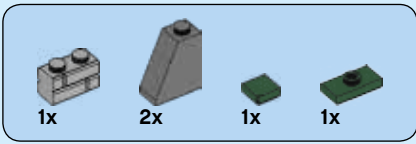

75

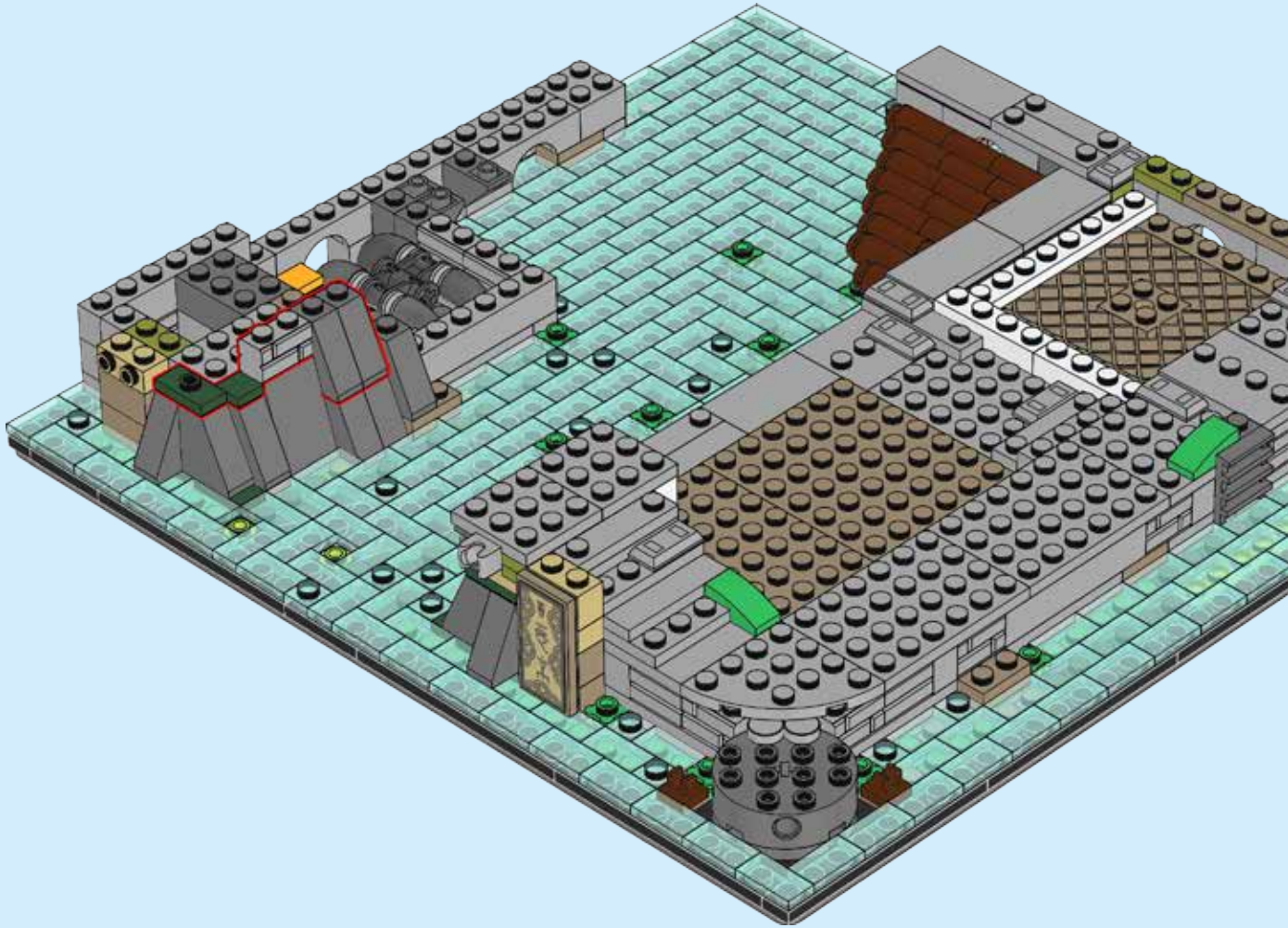

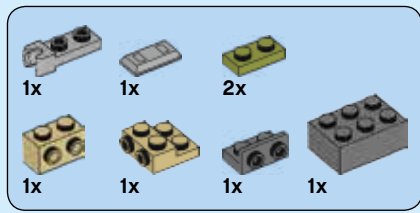

76

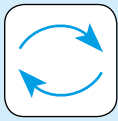
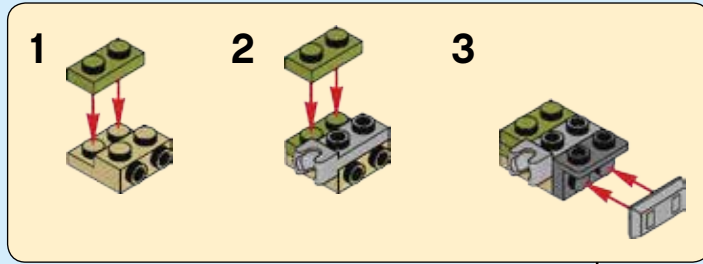

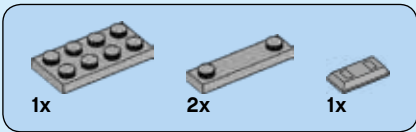

77

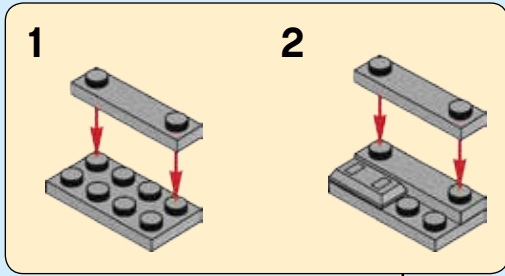

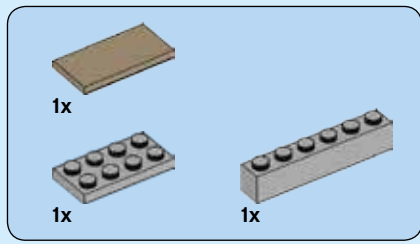

78

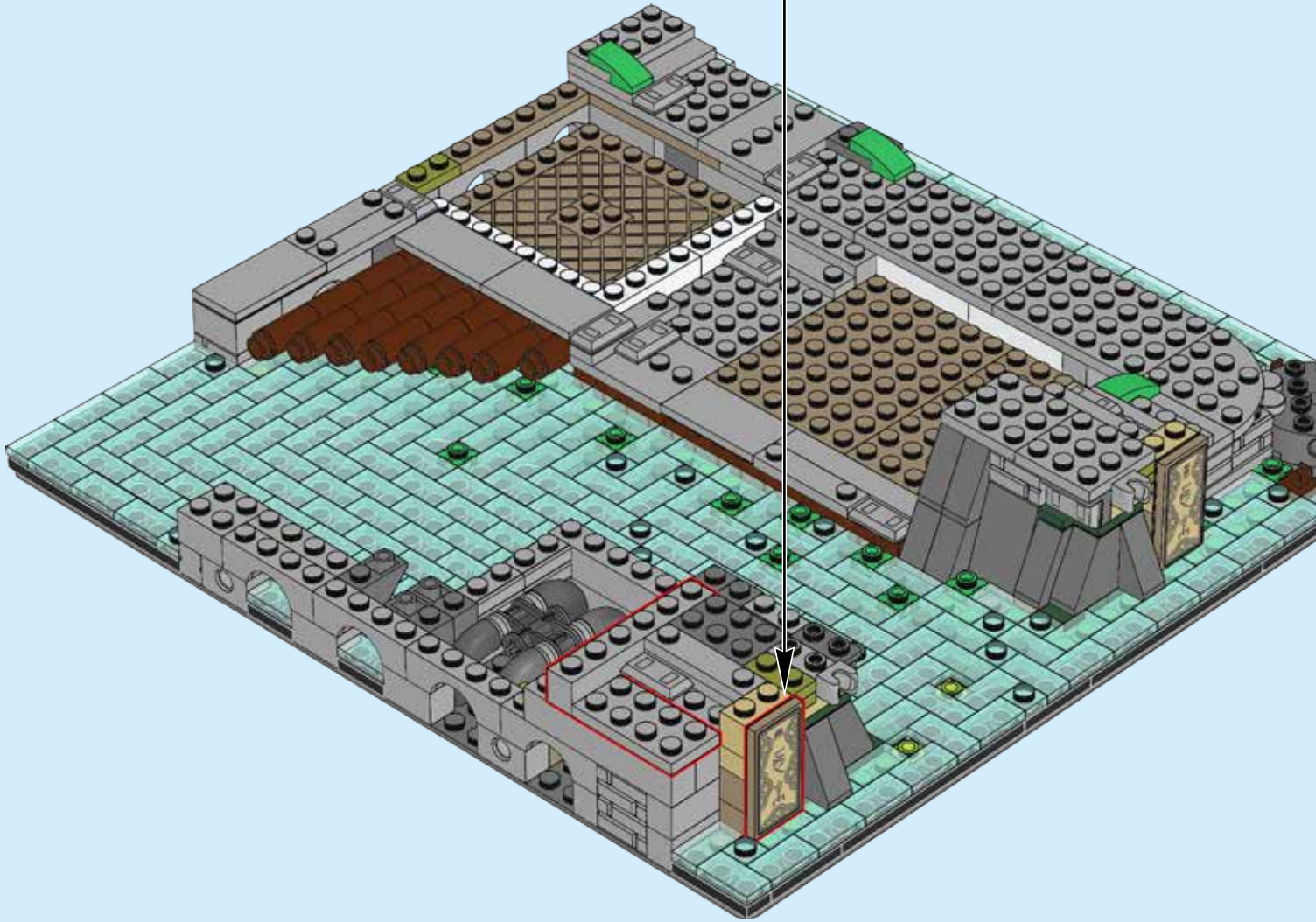
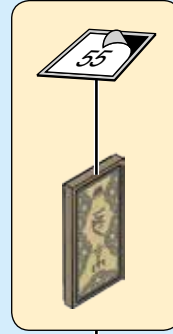

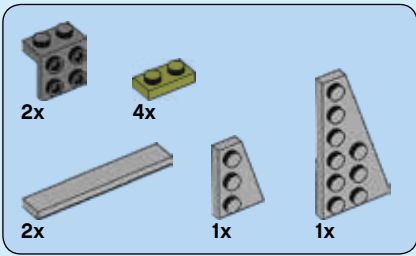

79

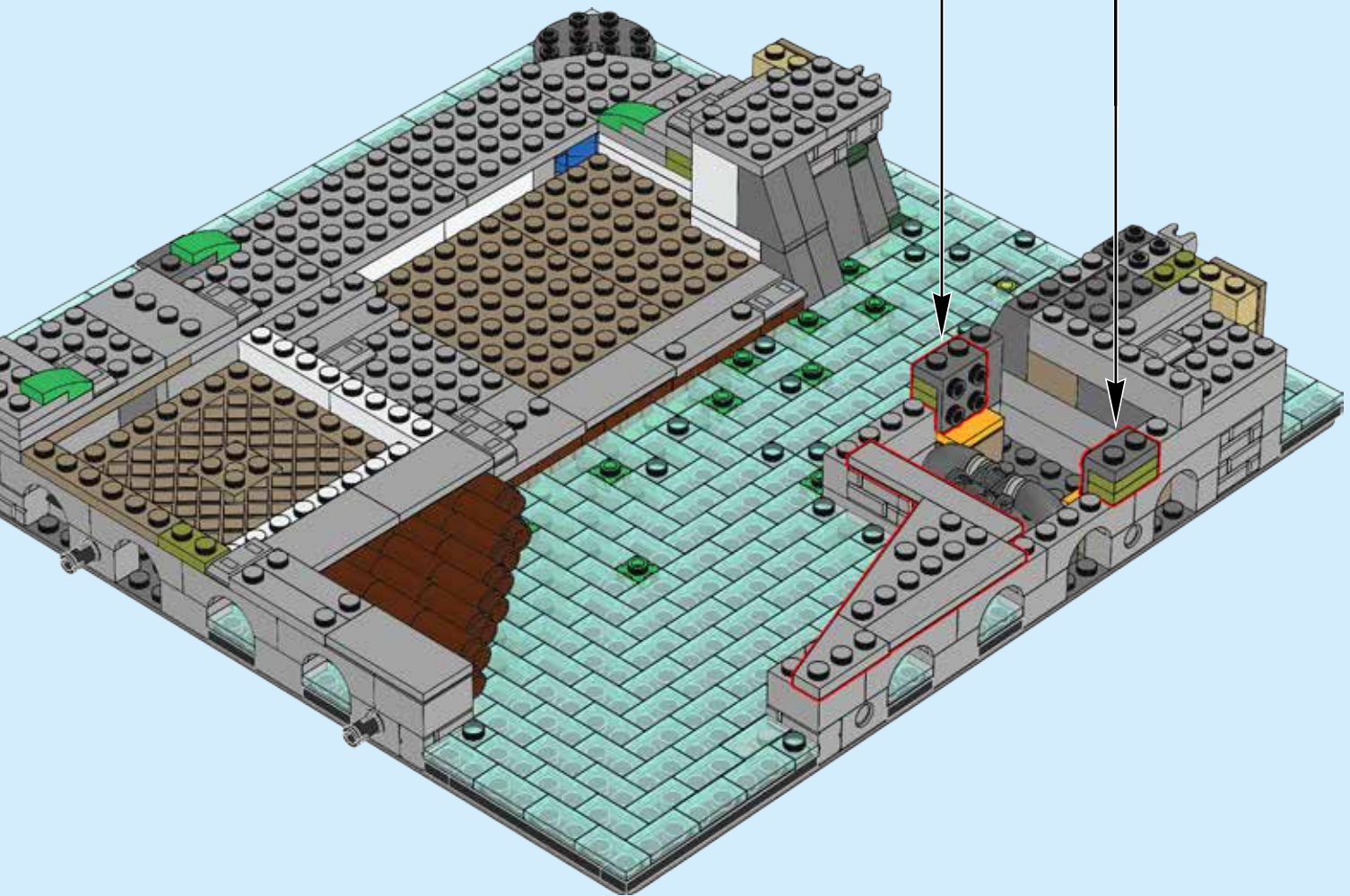
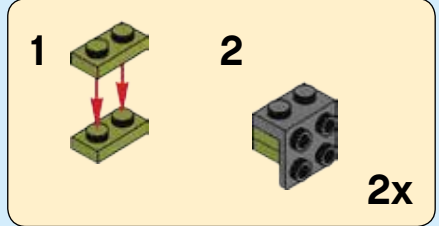



80

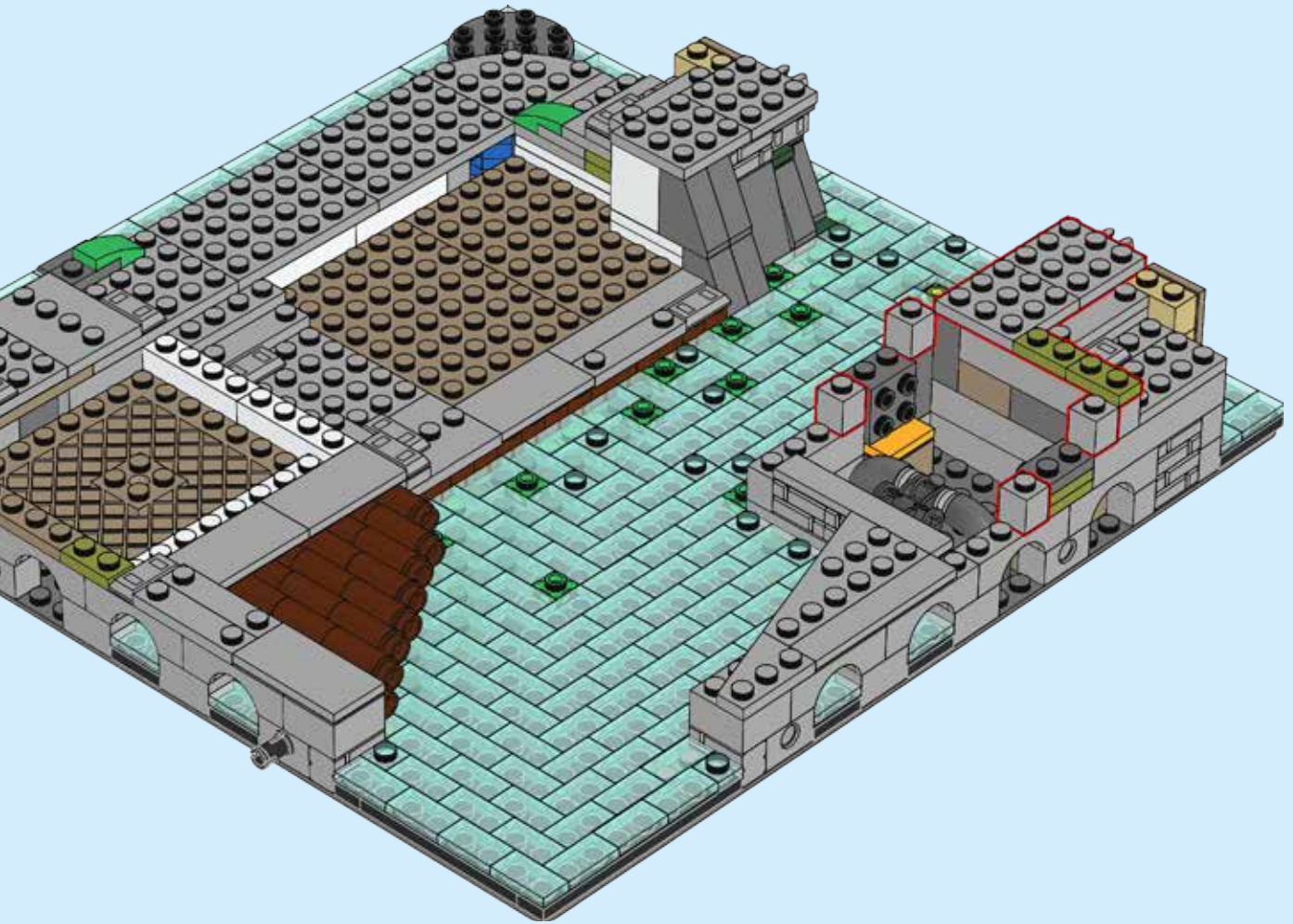

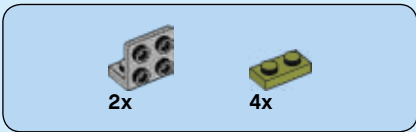

81

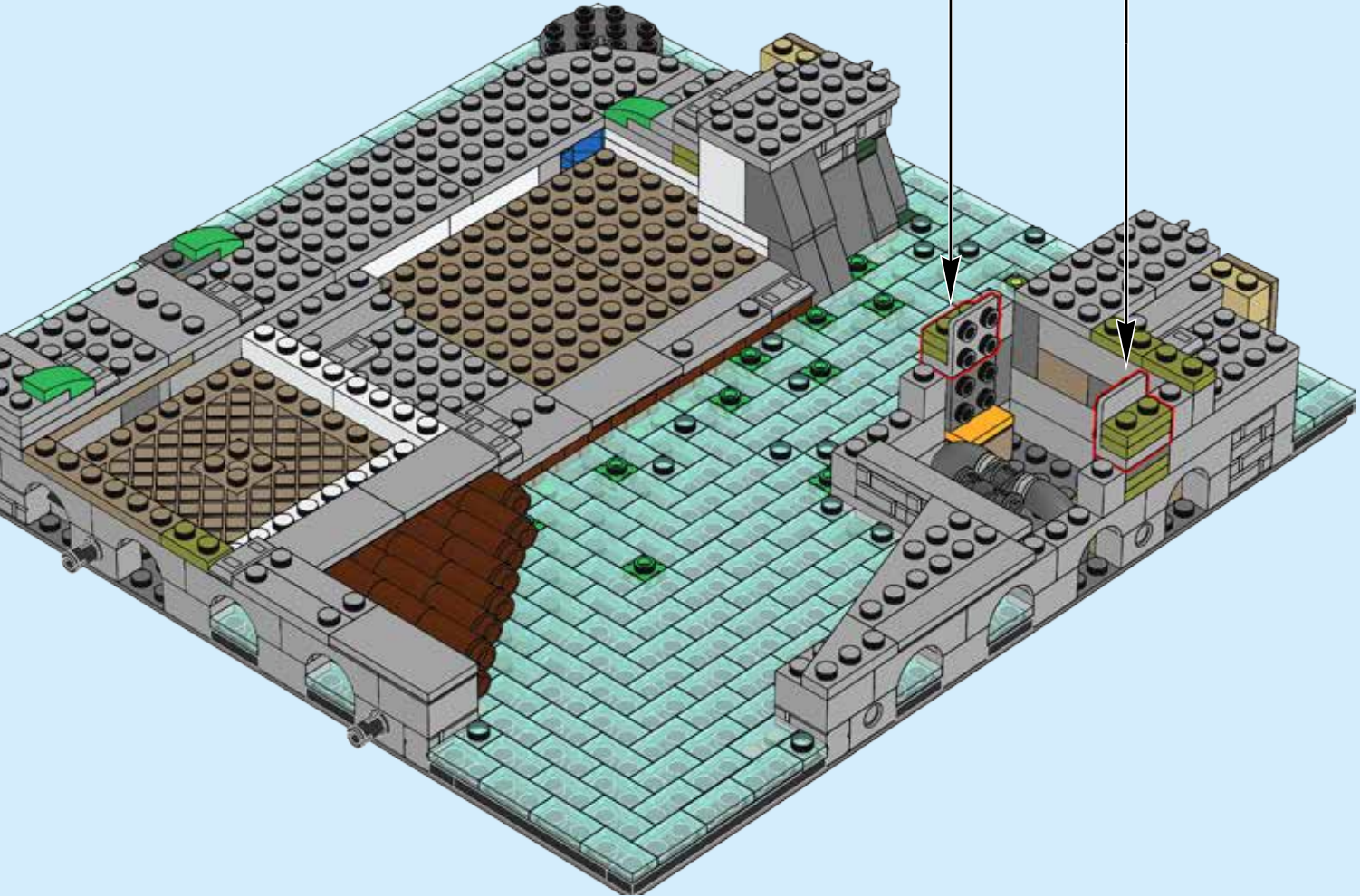
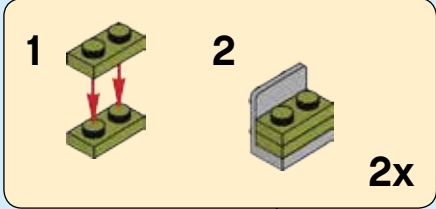

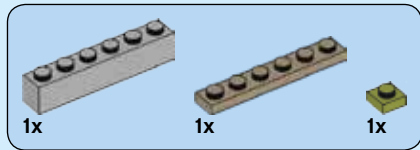

82

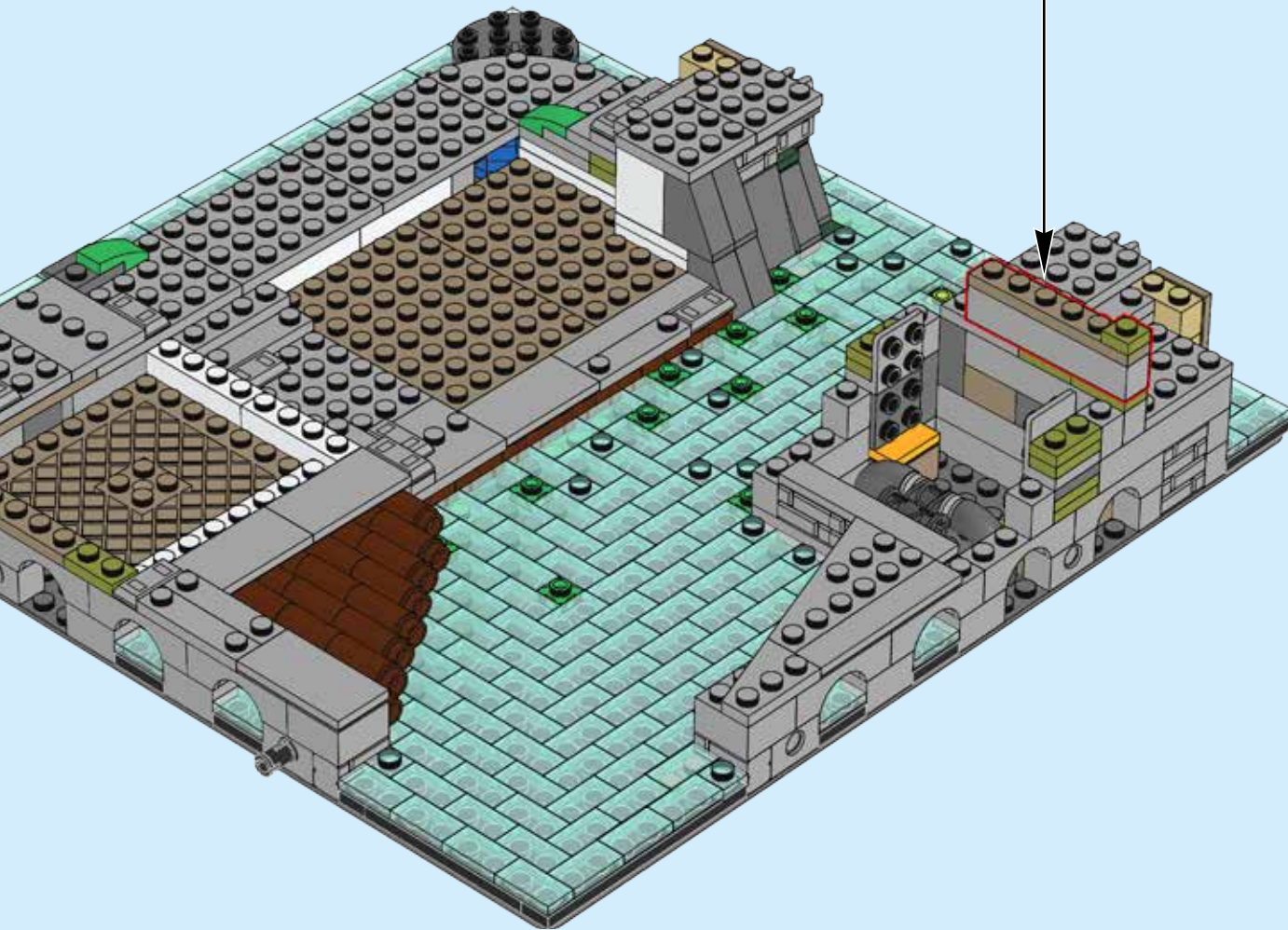
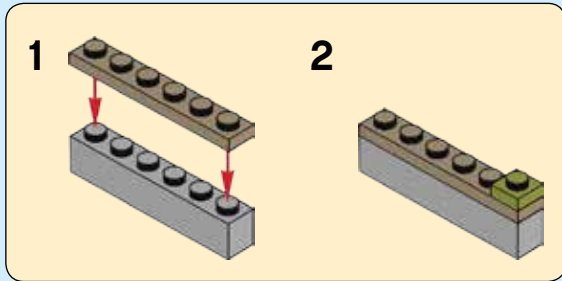

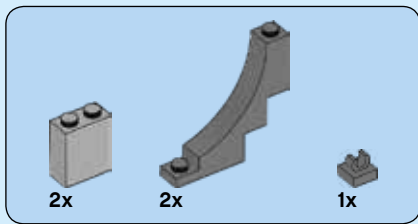

83

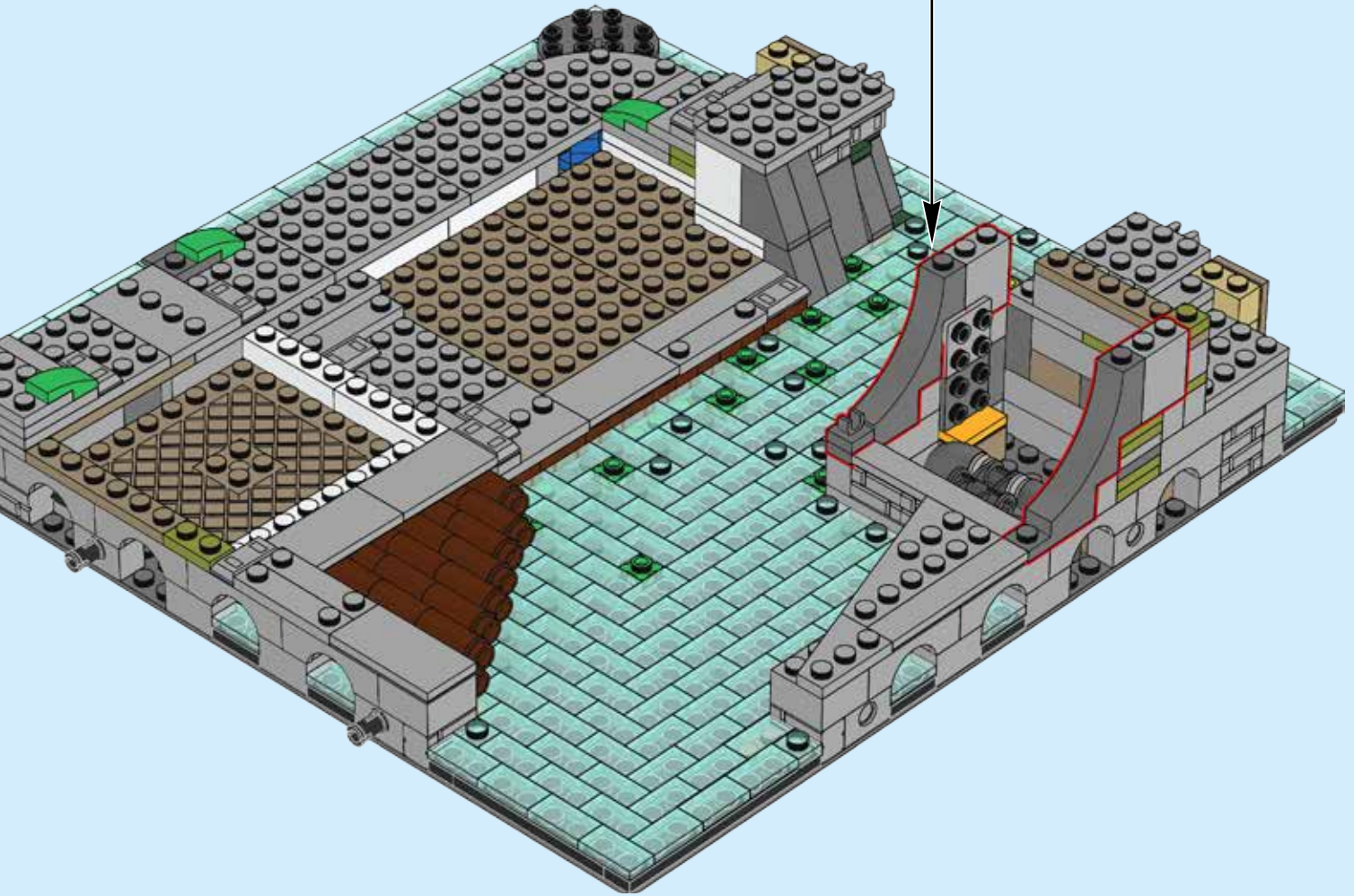
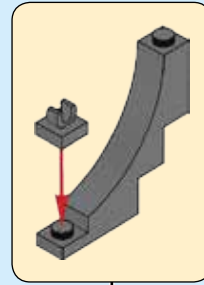



84

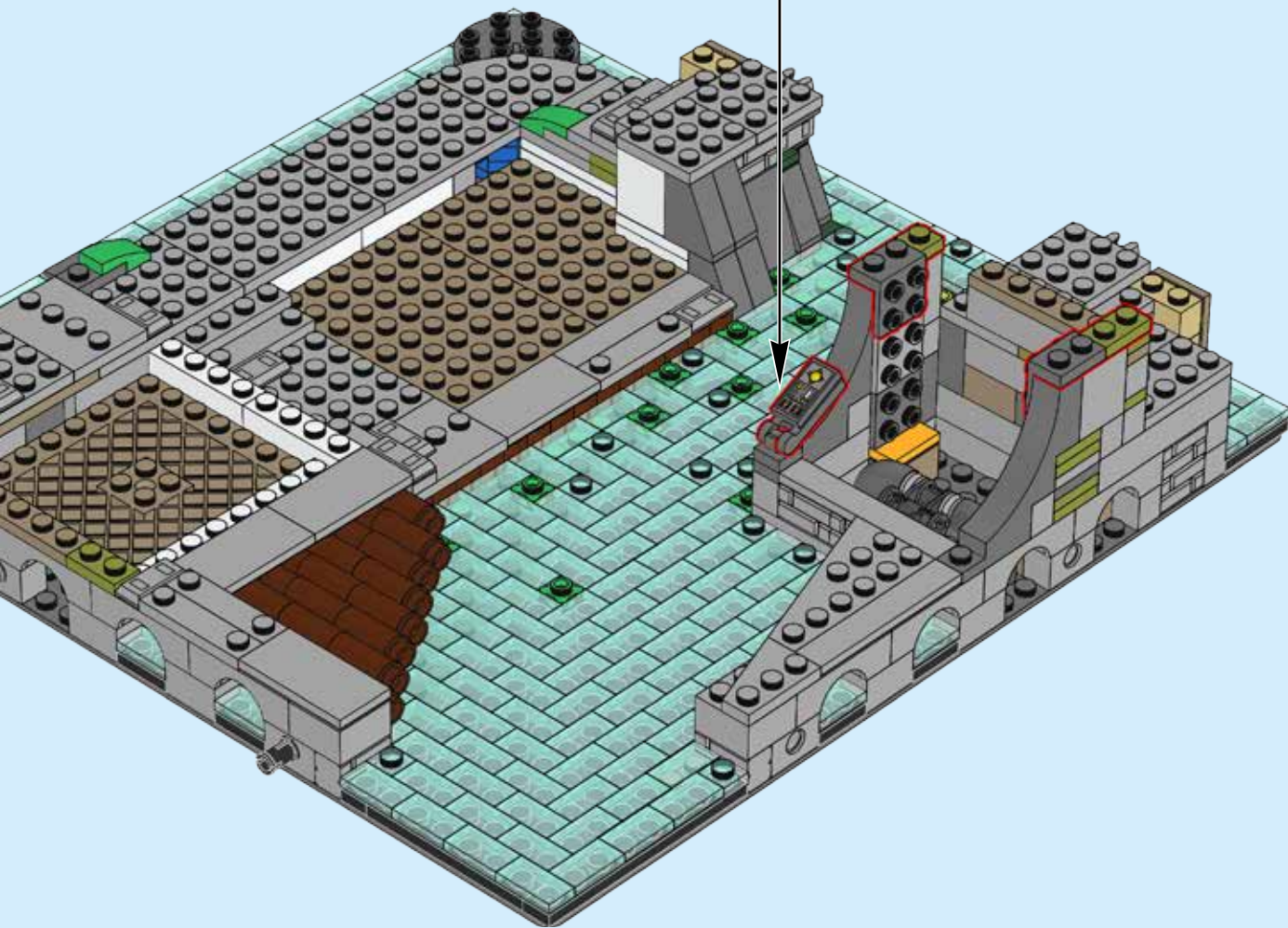

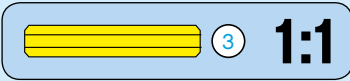
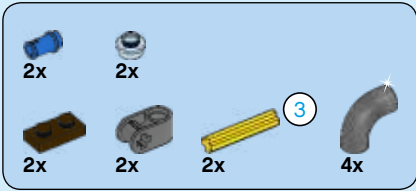
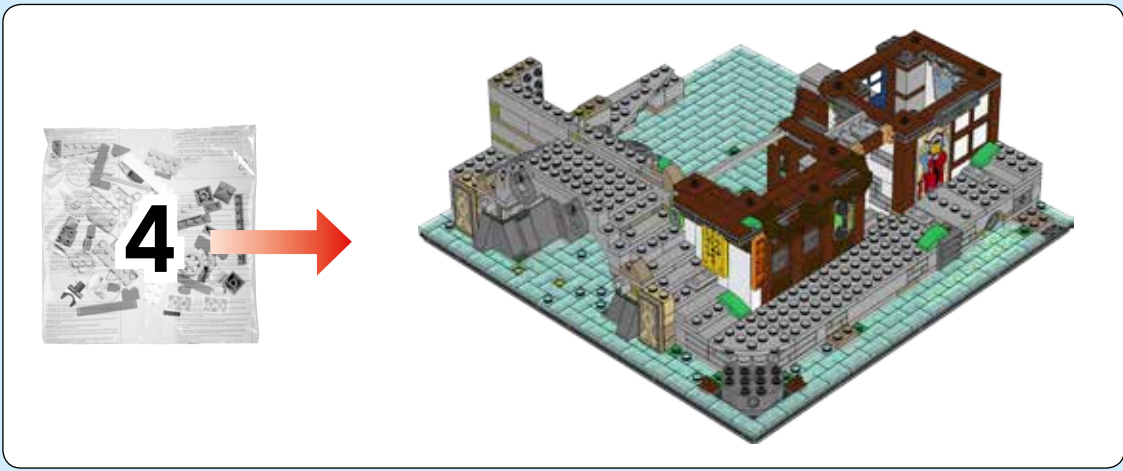

85

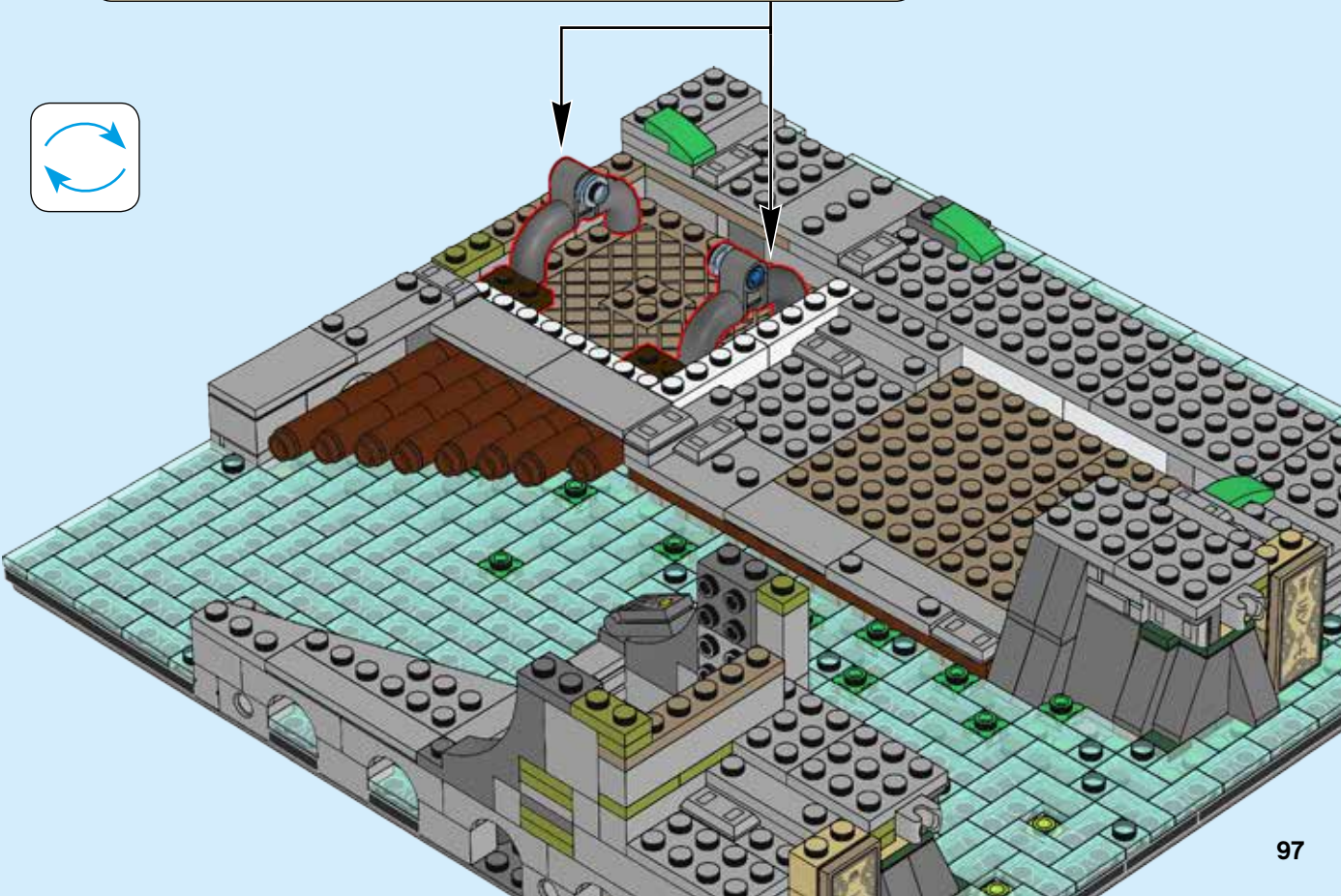
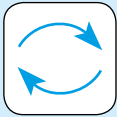
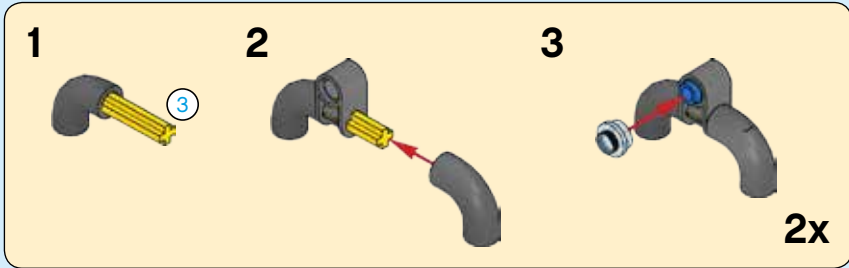

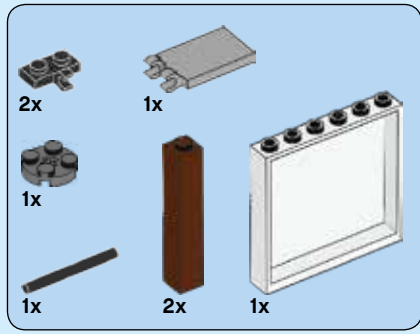

86

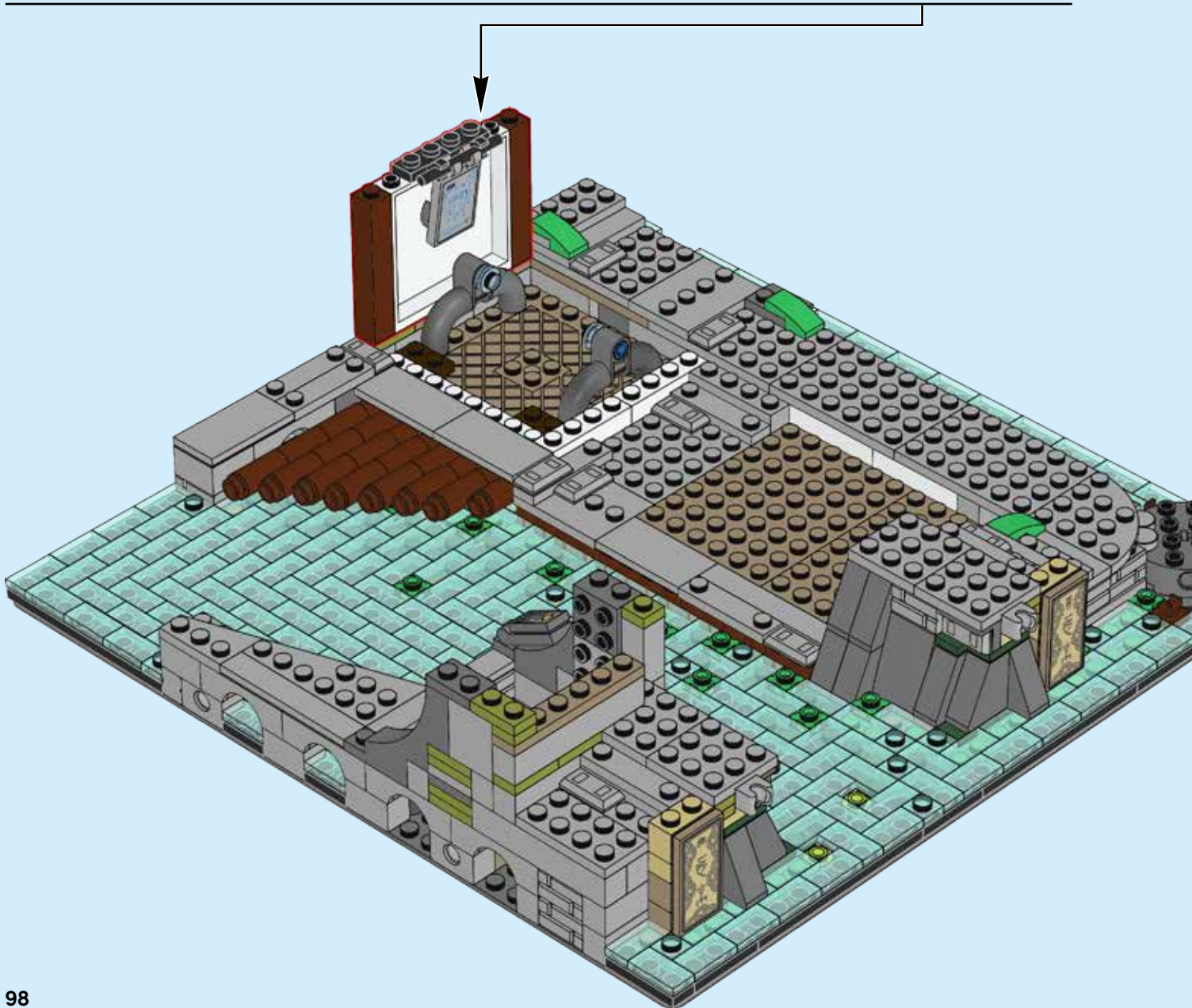
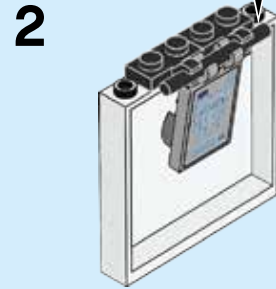
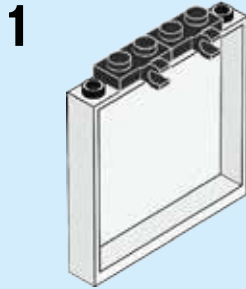
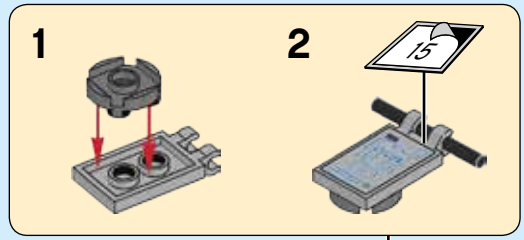

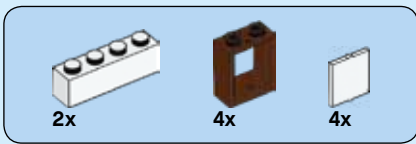

87

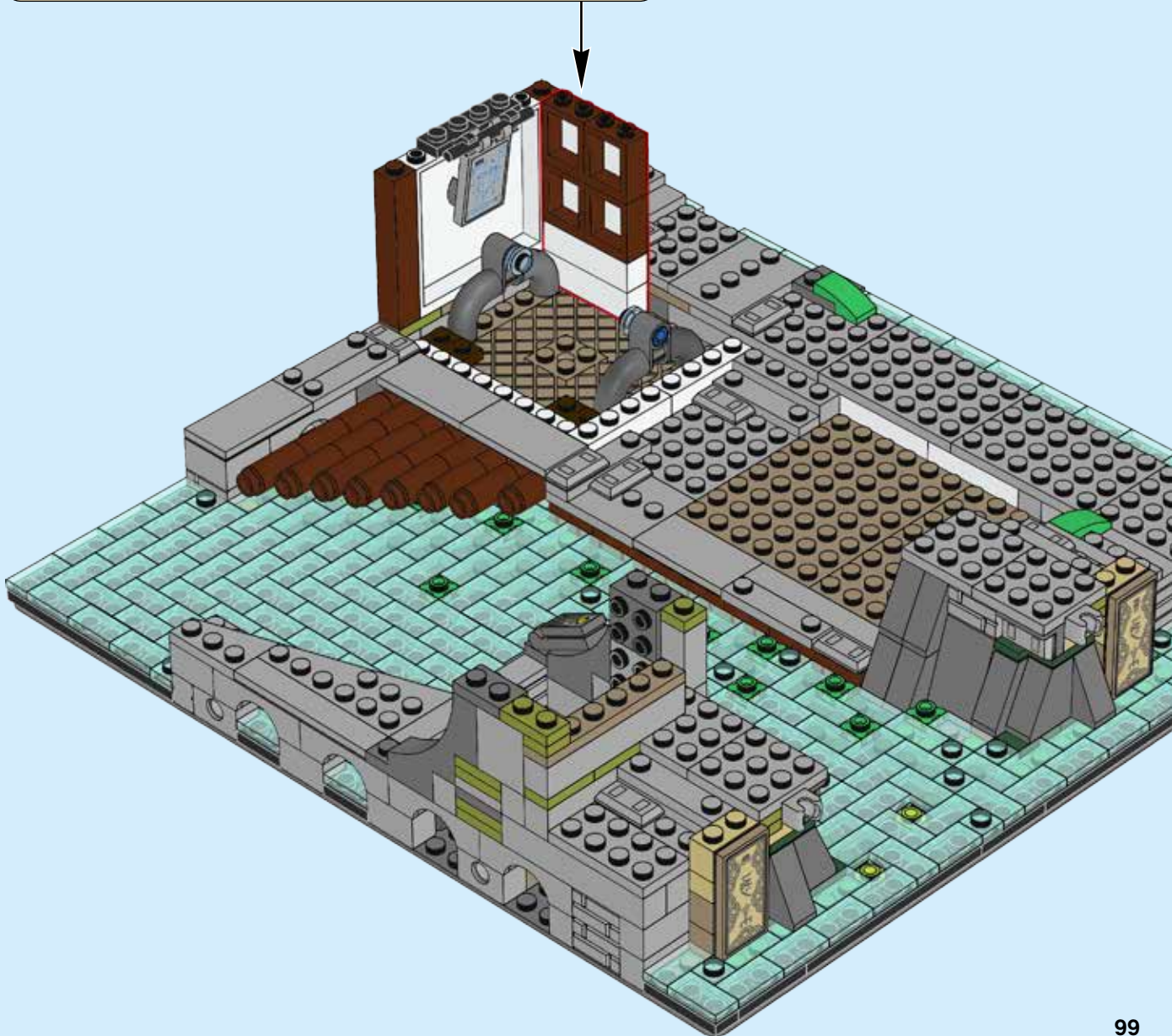
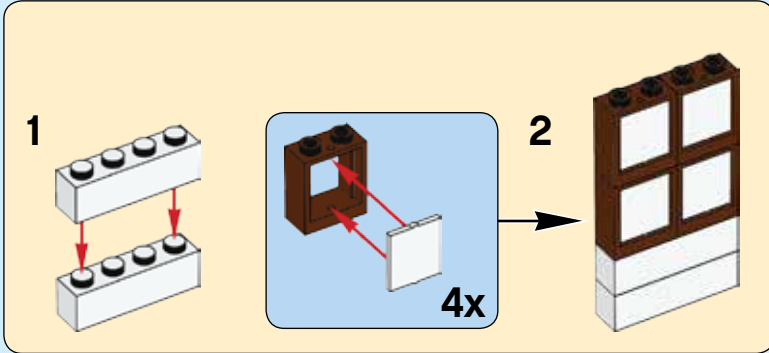

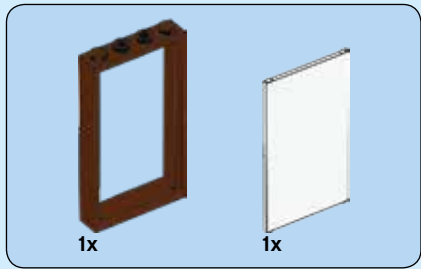

88

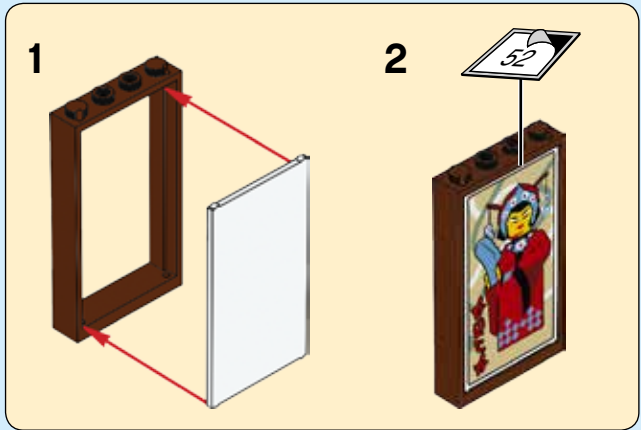

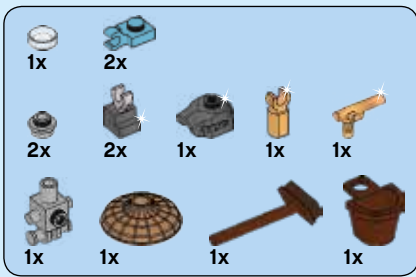

89

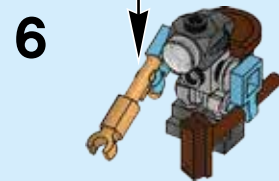
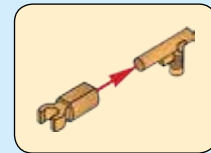
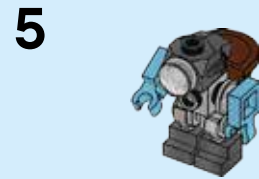
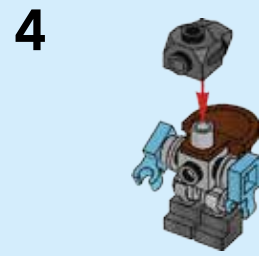
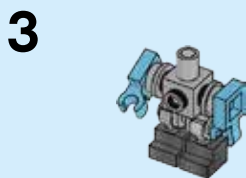
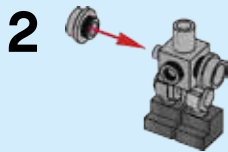
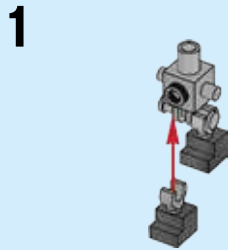

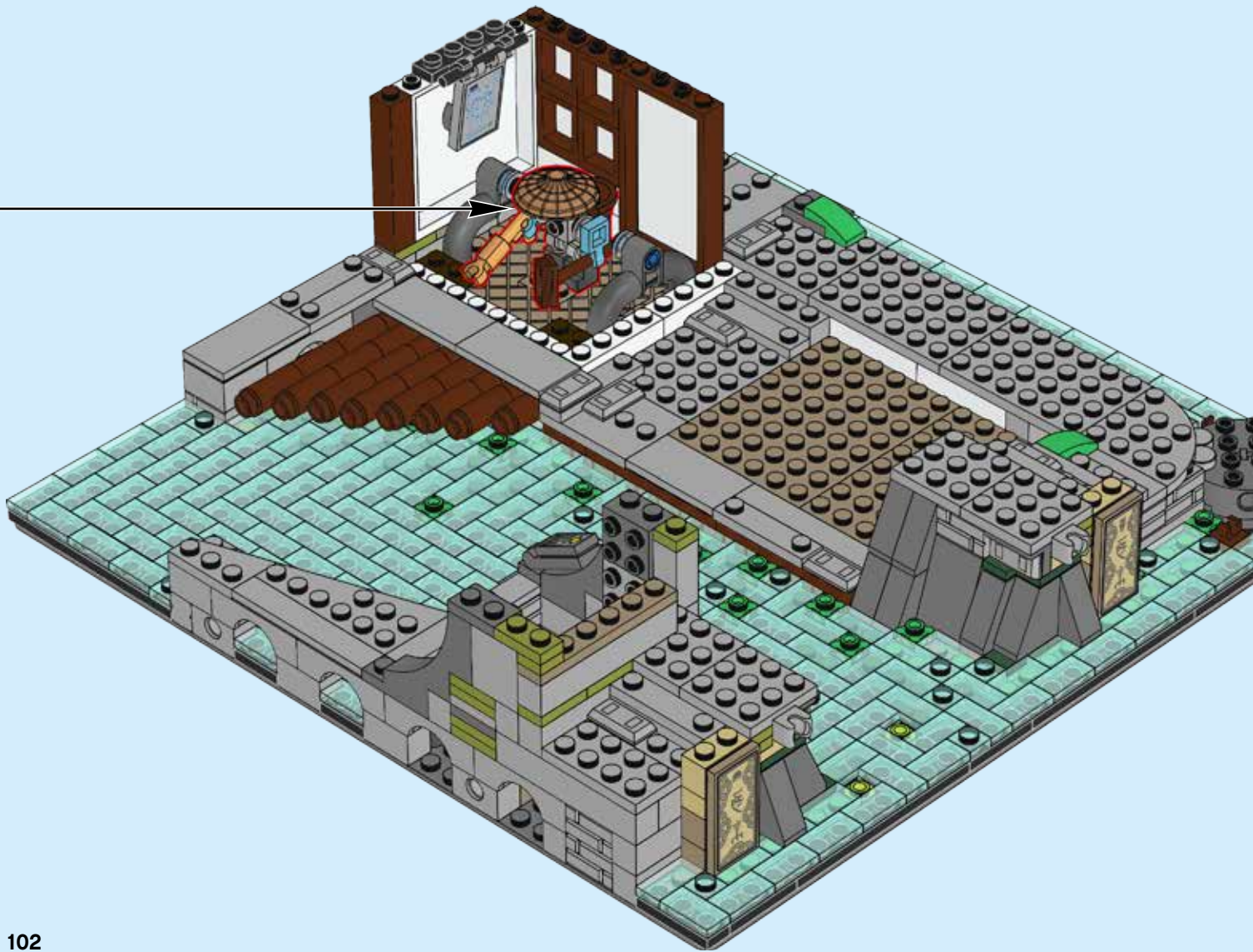



90

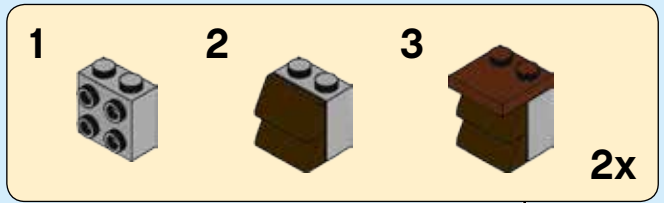

1



2



3



4

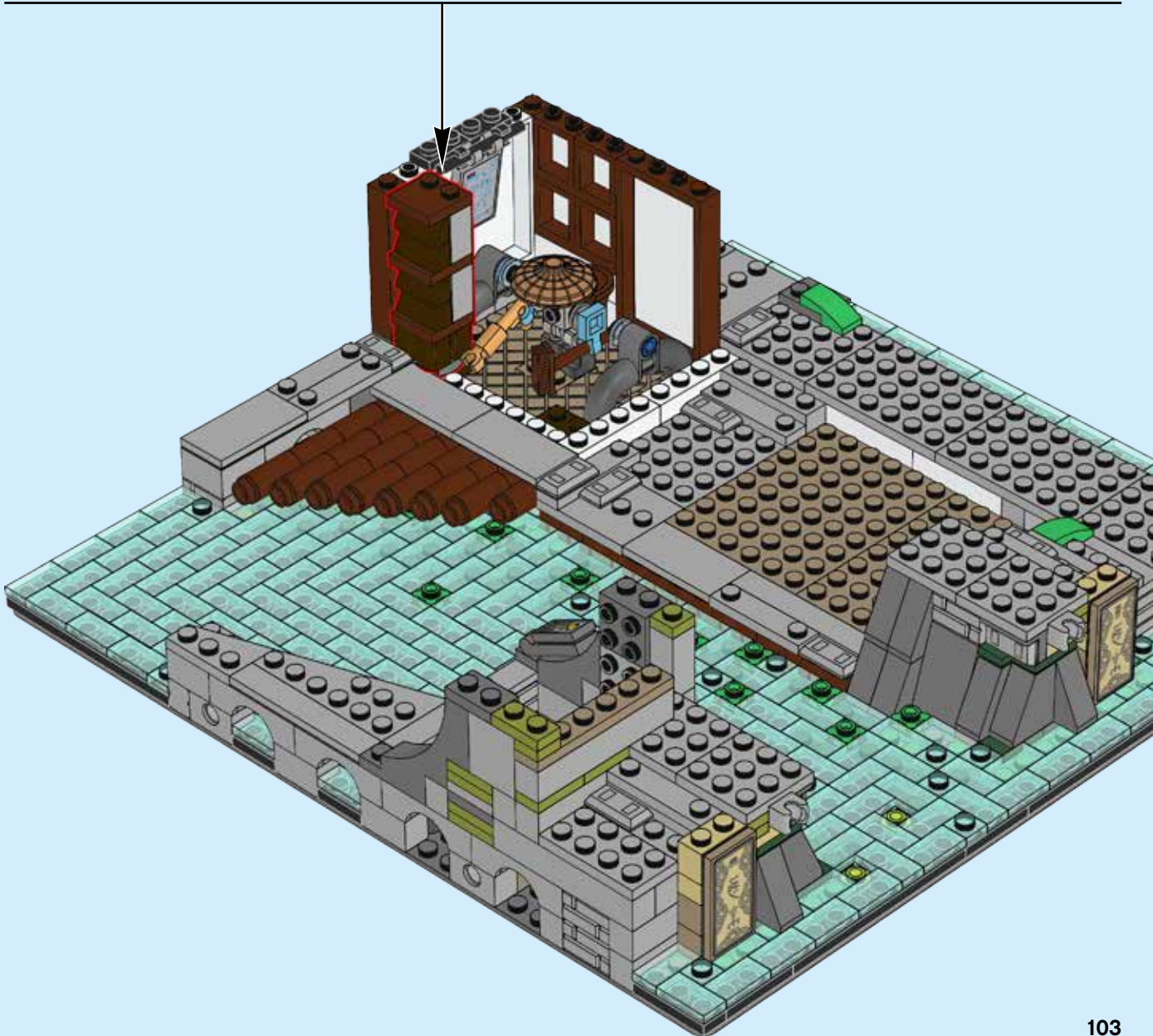

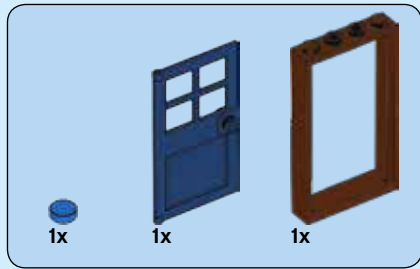

91

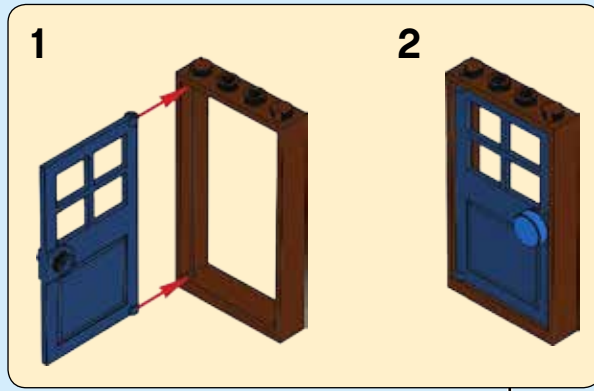

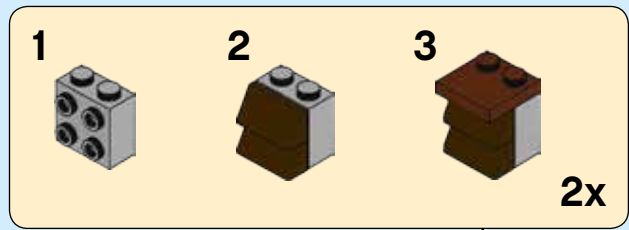
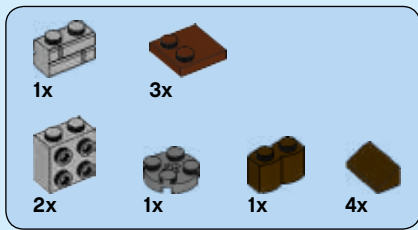

92

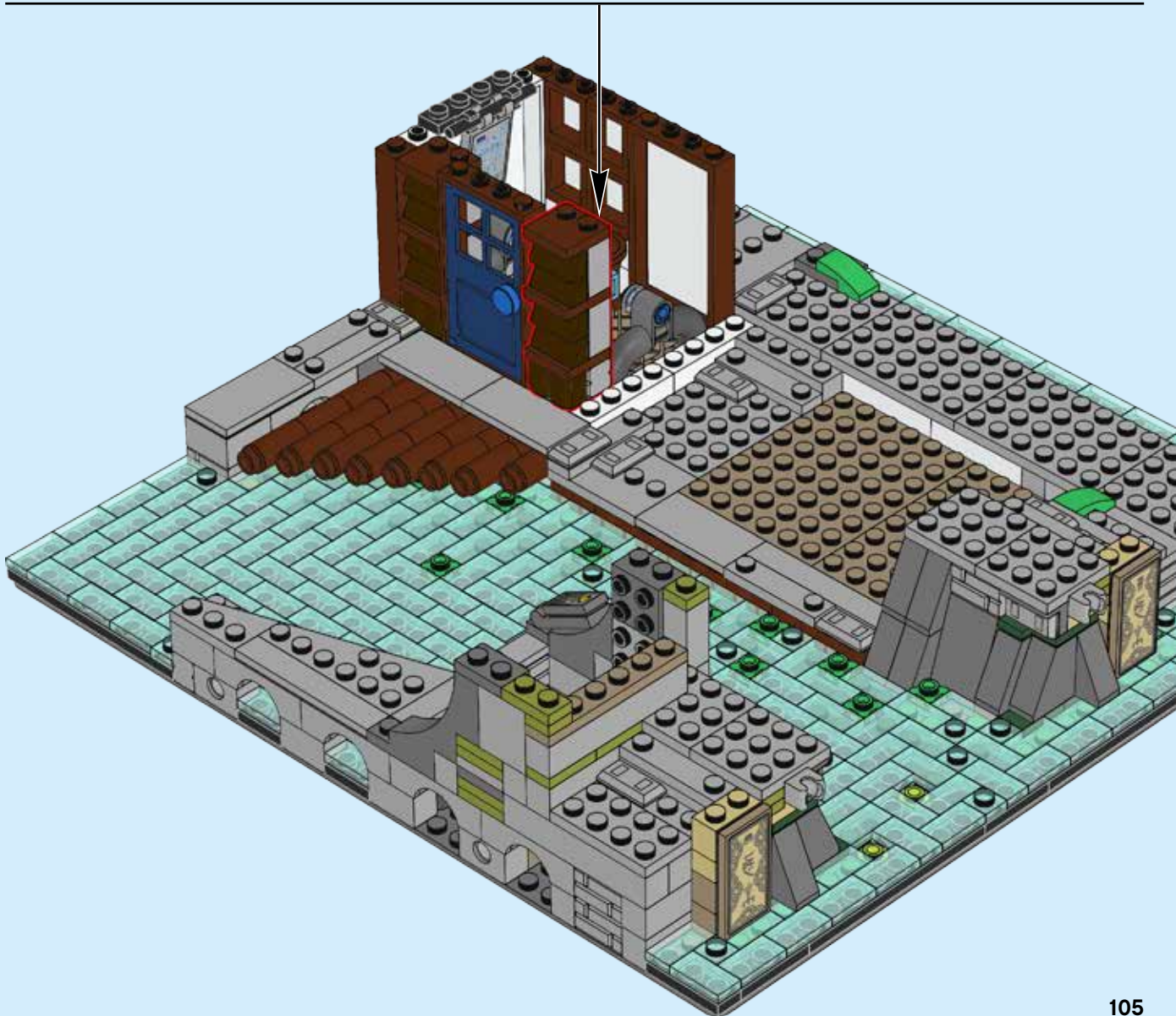
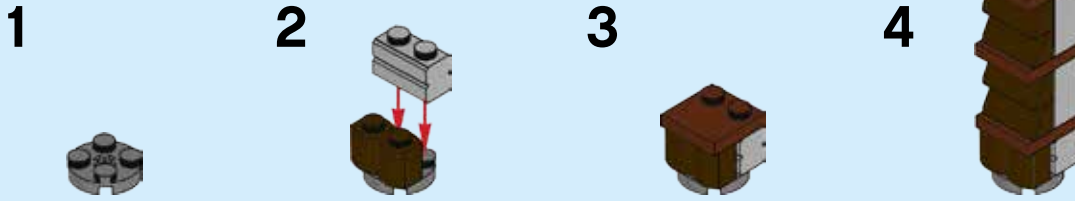

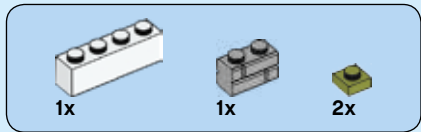

93

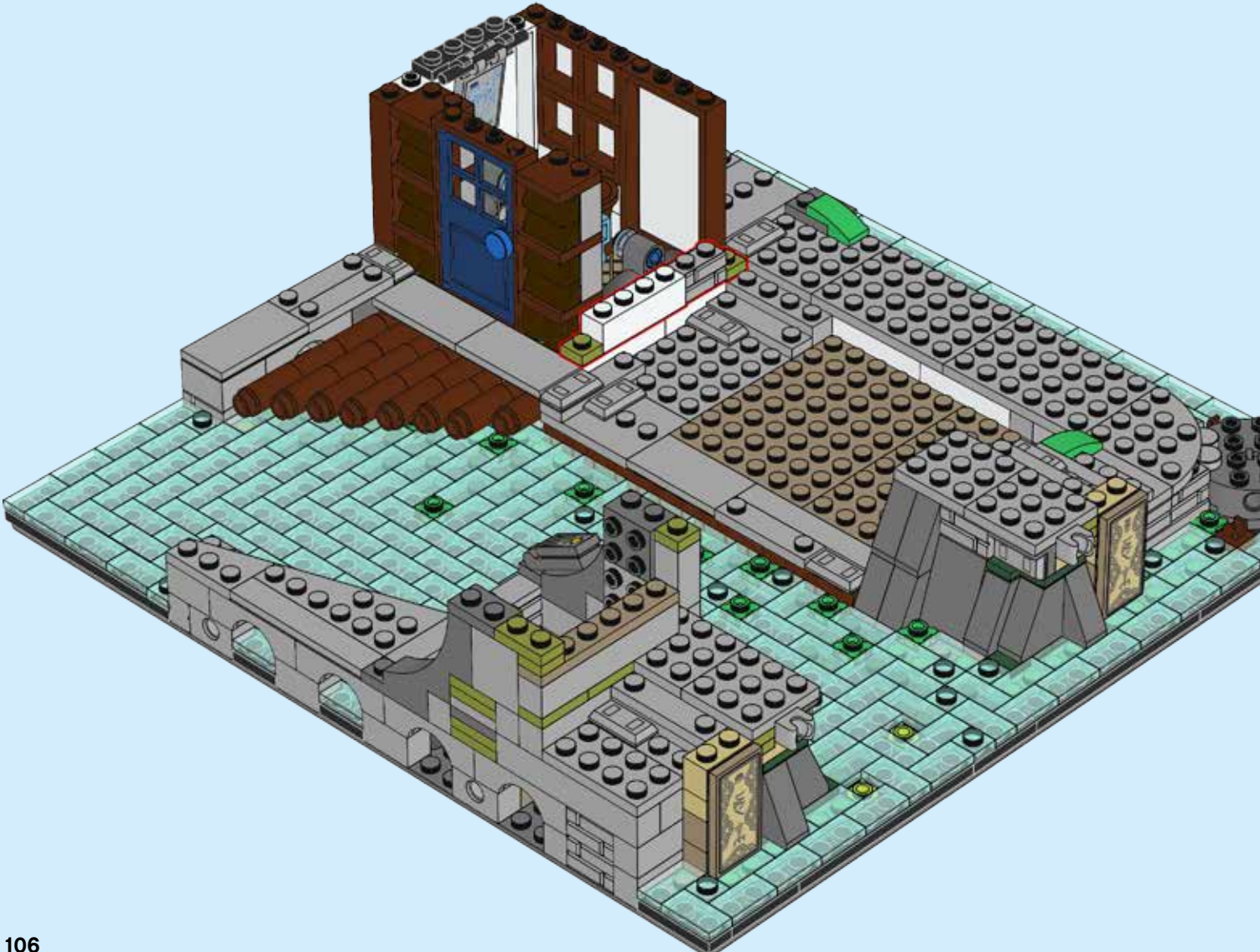

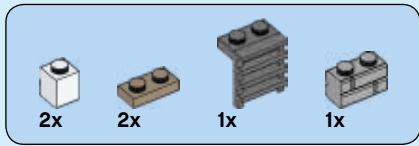

94

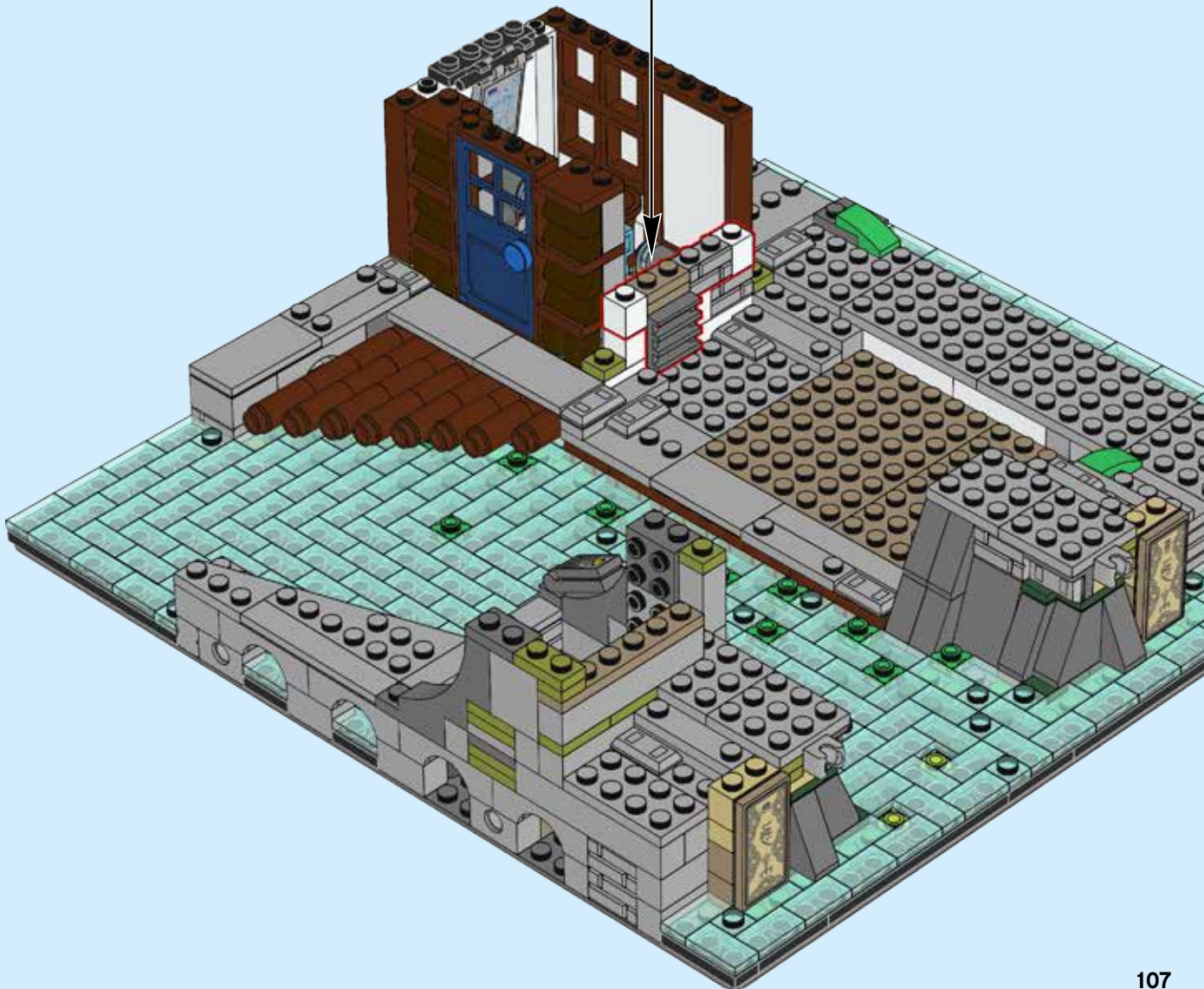
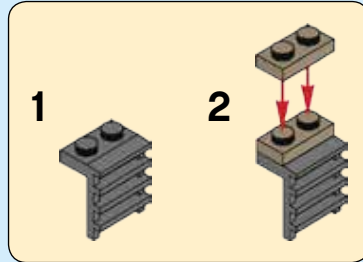

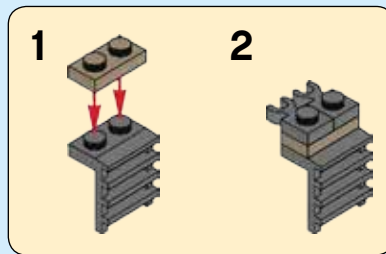
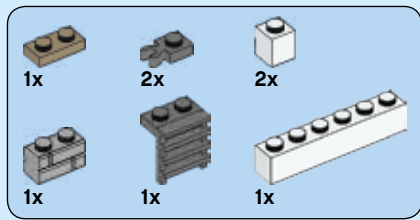

95

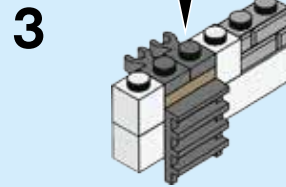
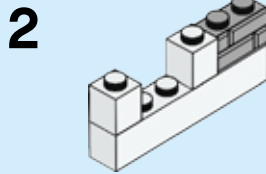
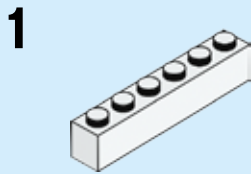

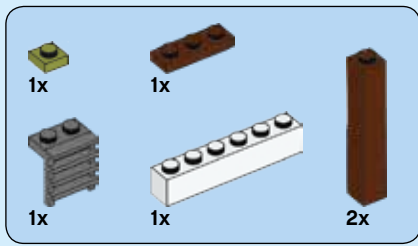

96

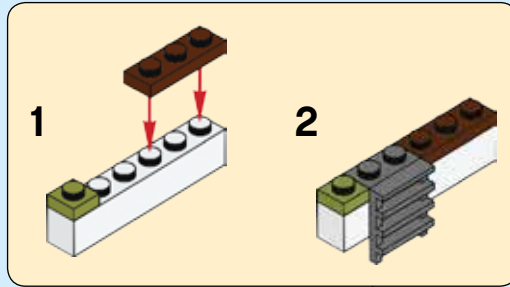

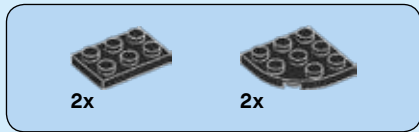

97



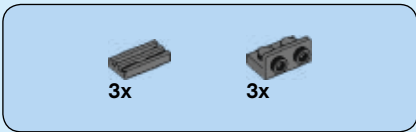

98

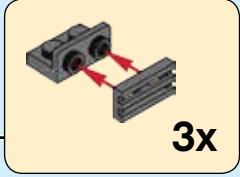
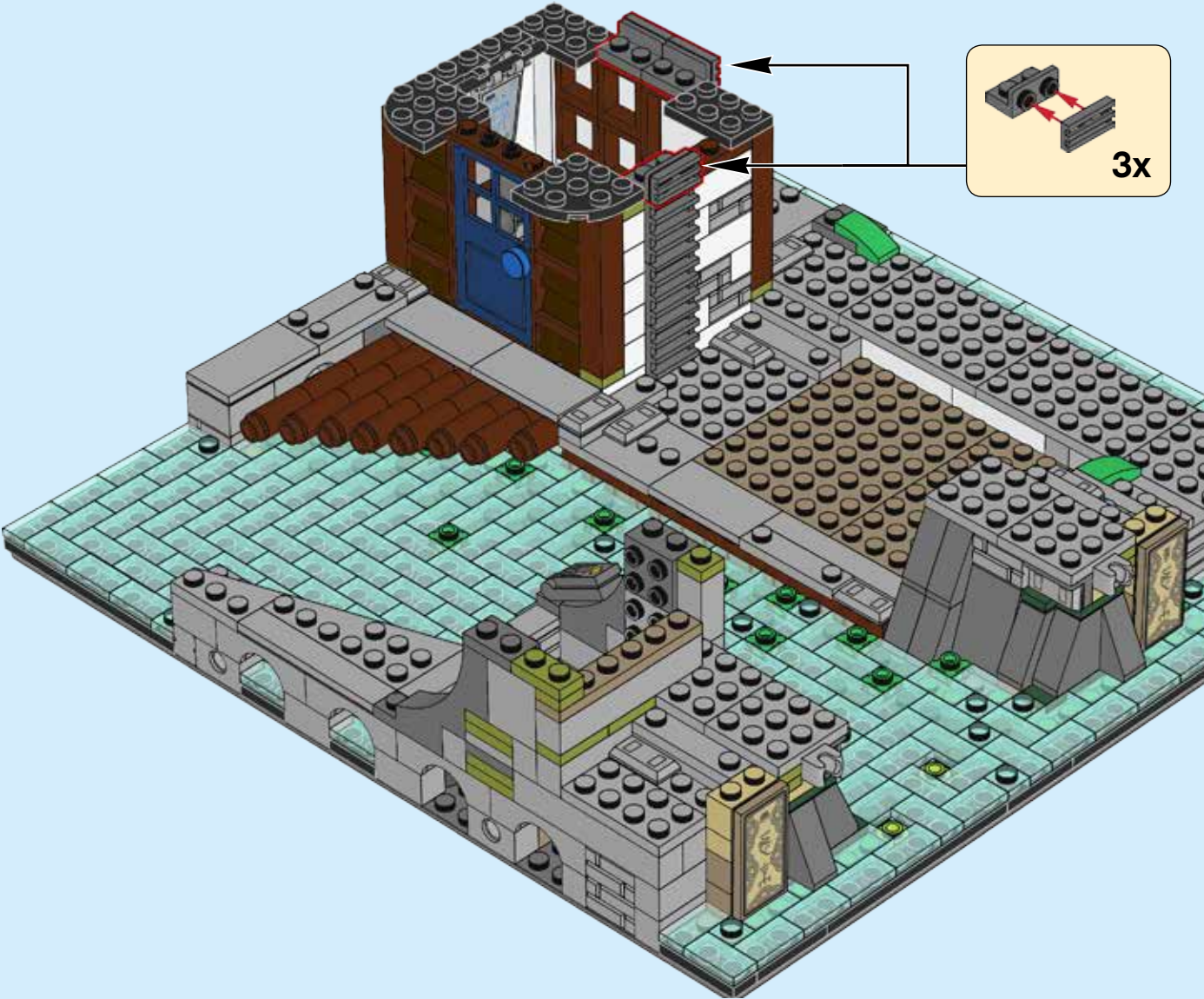

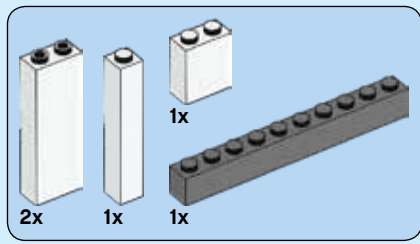

99

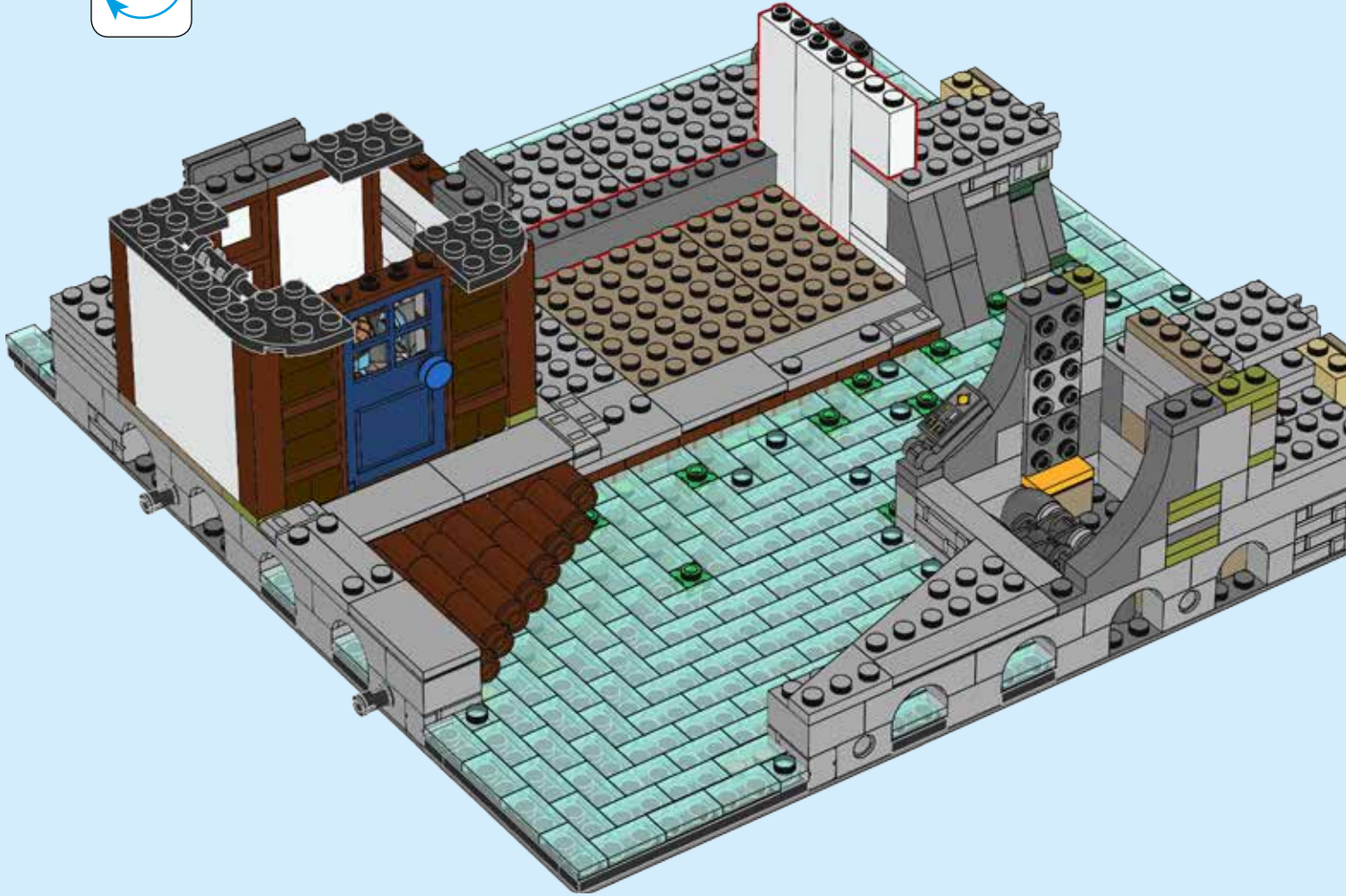
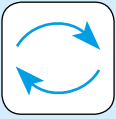



100

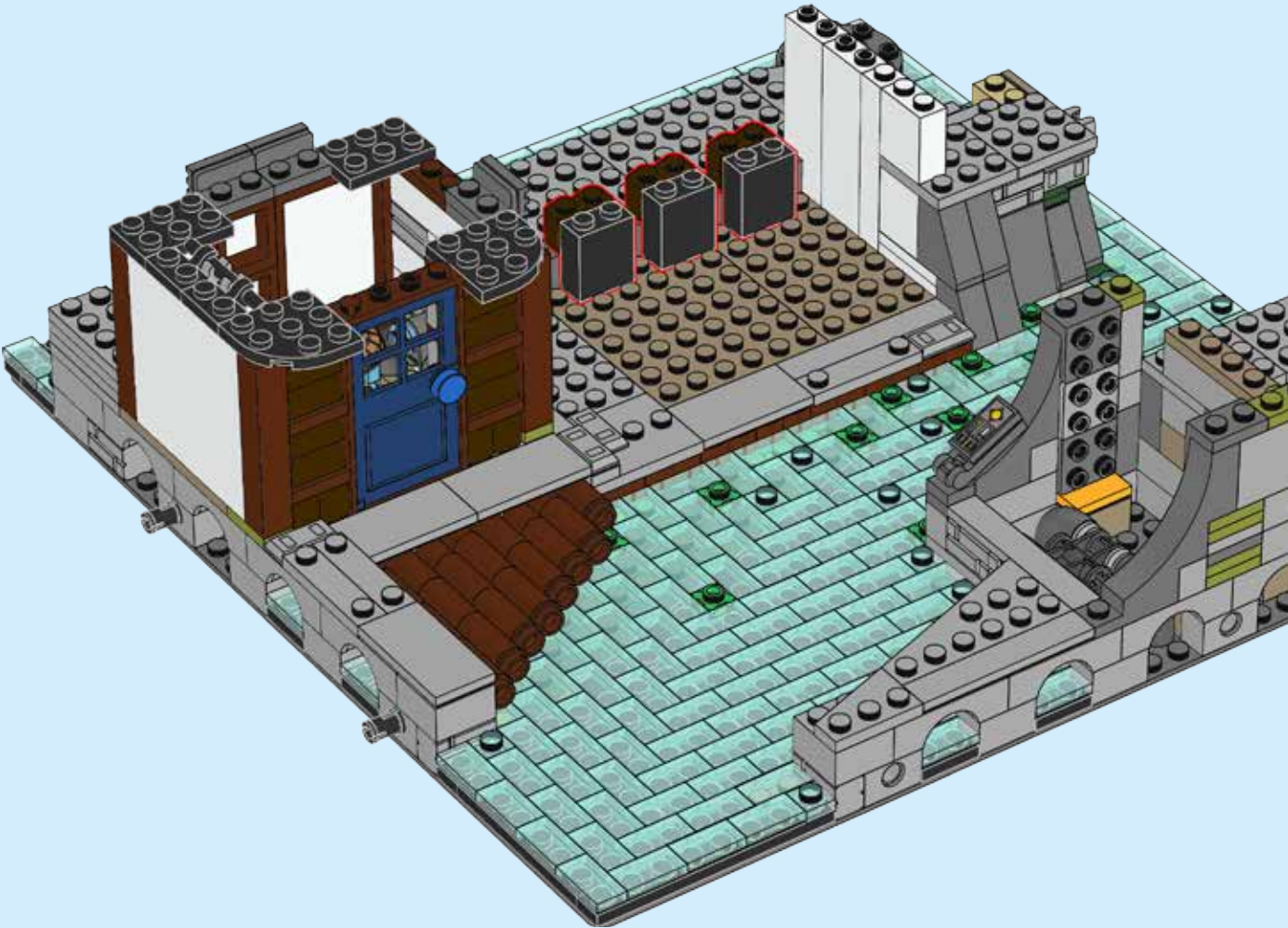

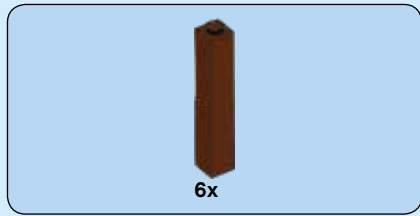

101

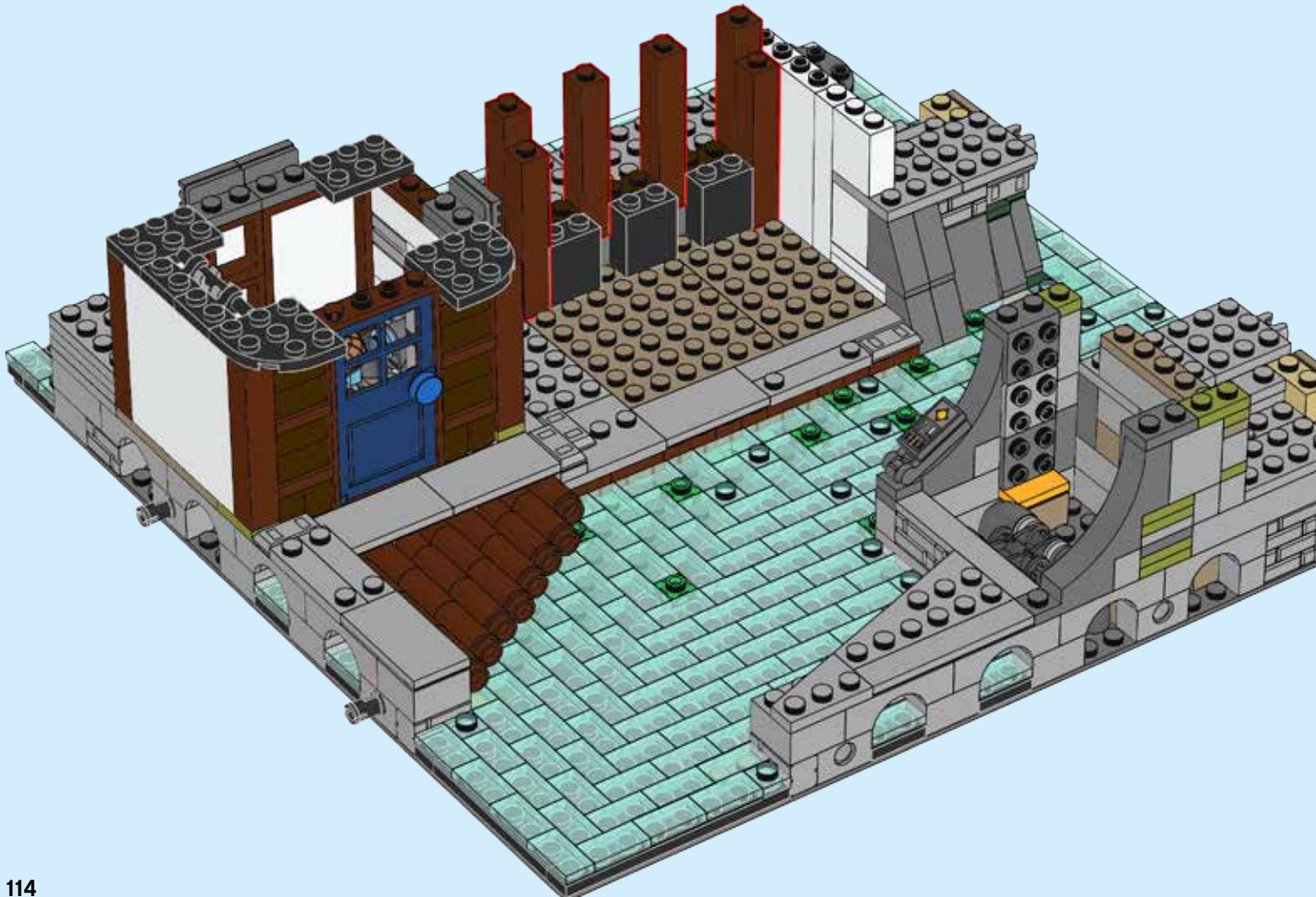

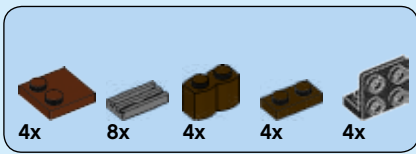

102

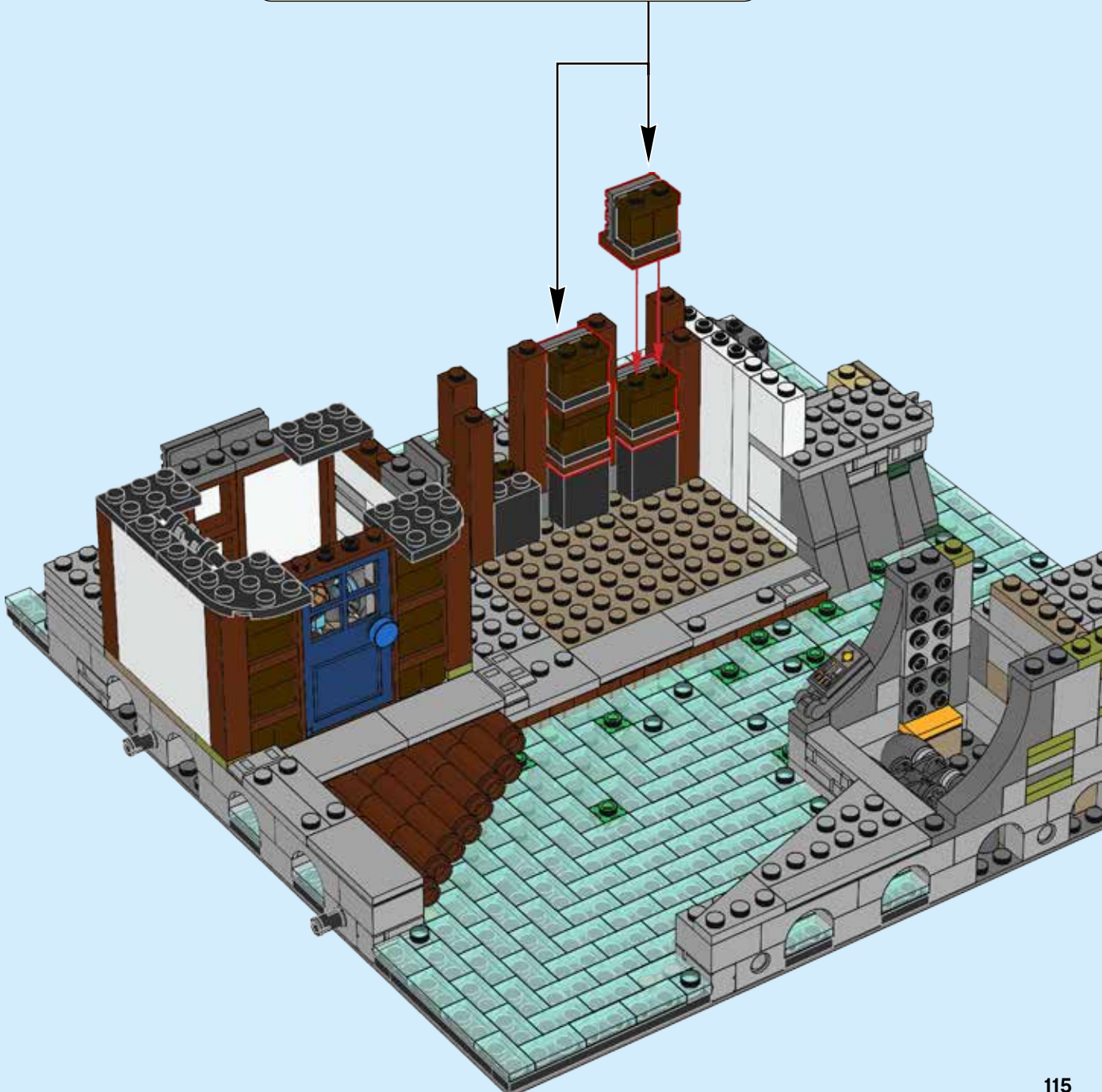
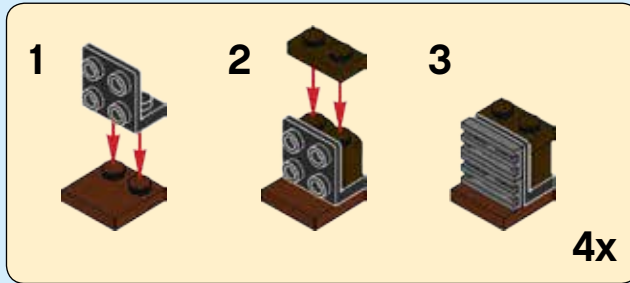



103

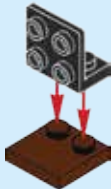

104

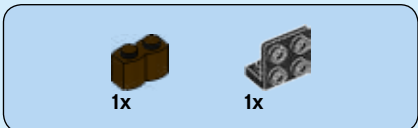

105



106

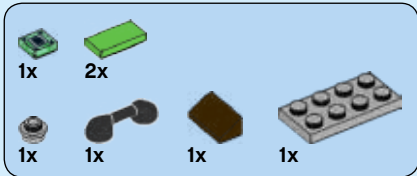
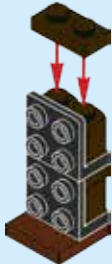

107

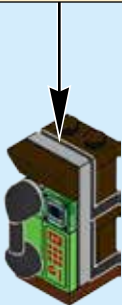
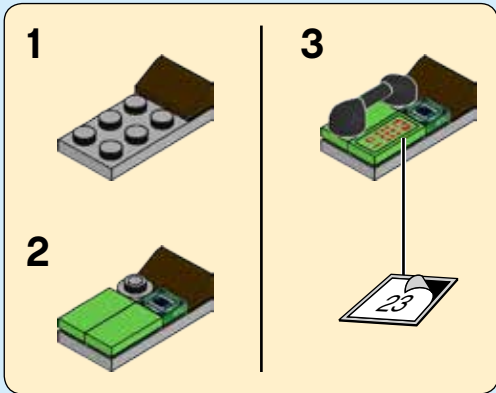



108



109

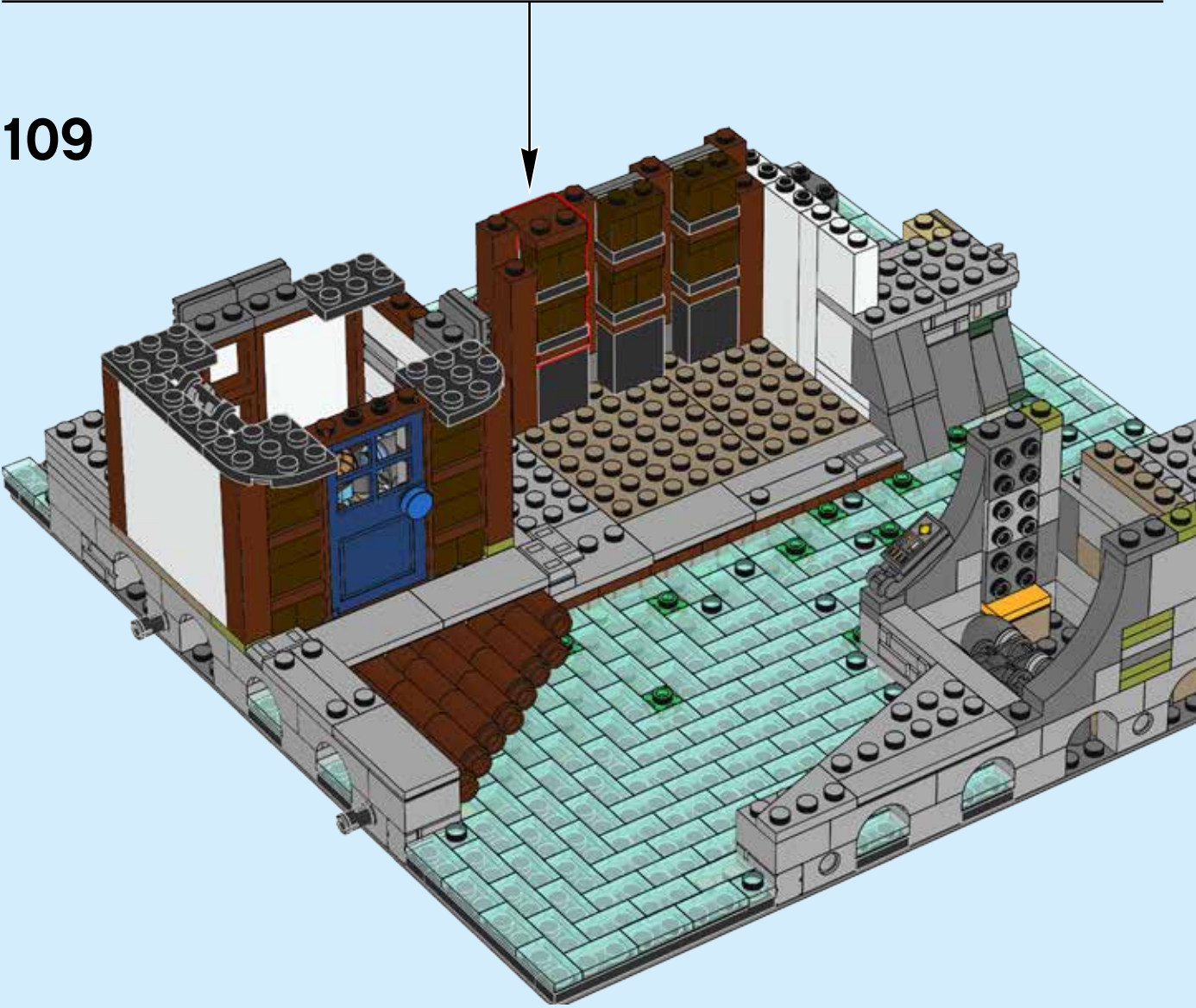

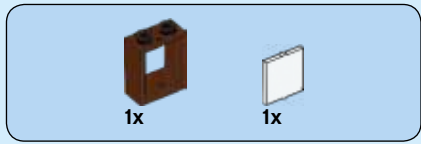

110

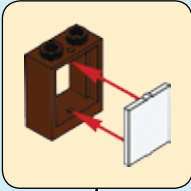

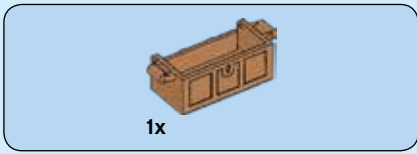

111

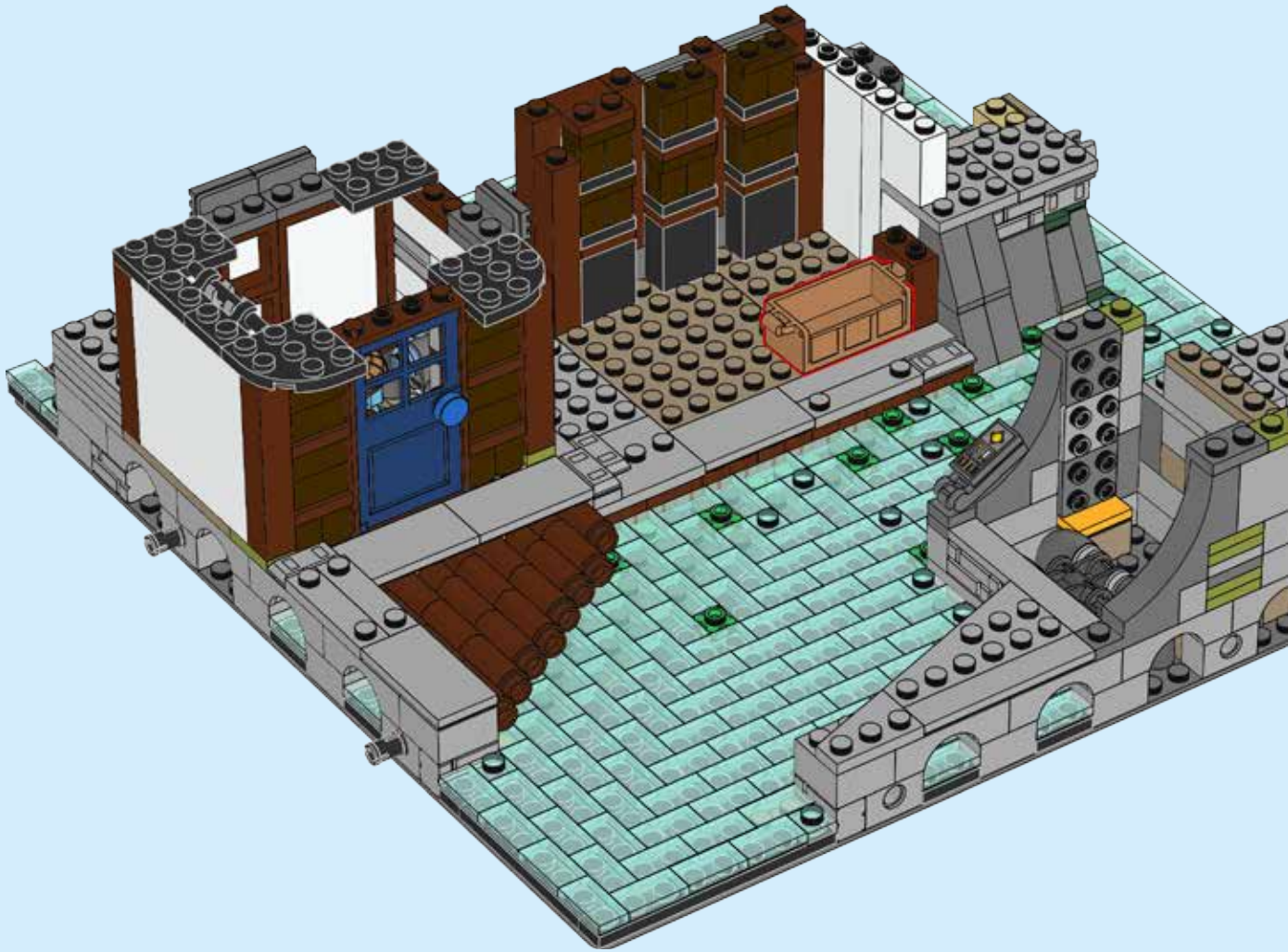

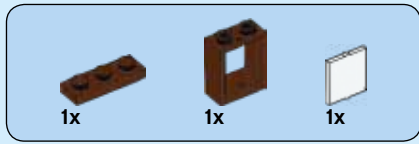

112

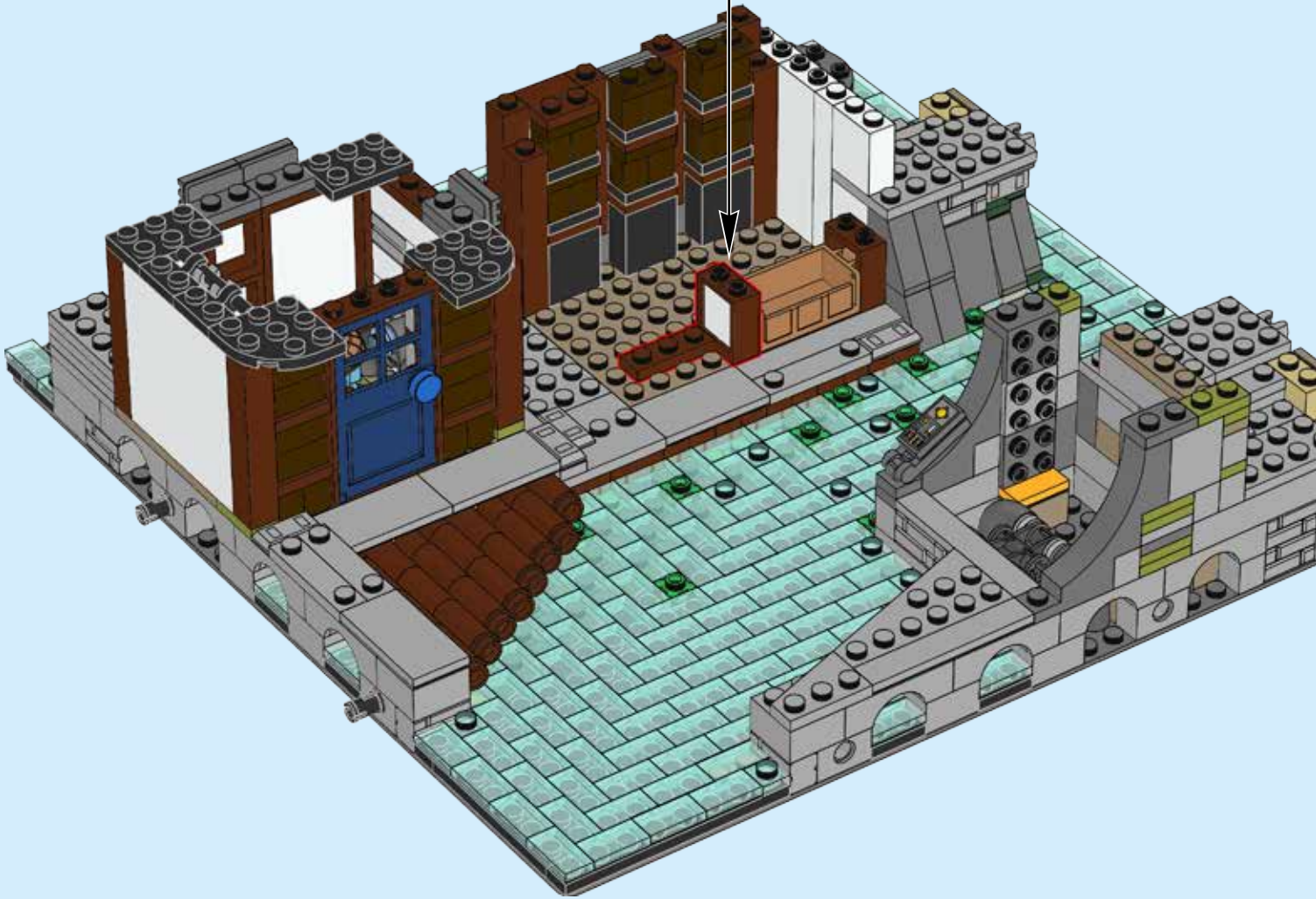
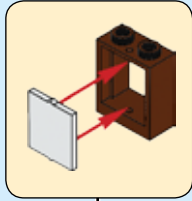

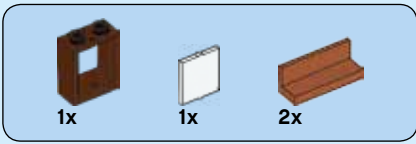

113

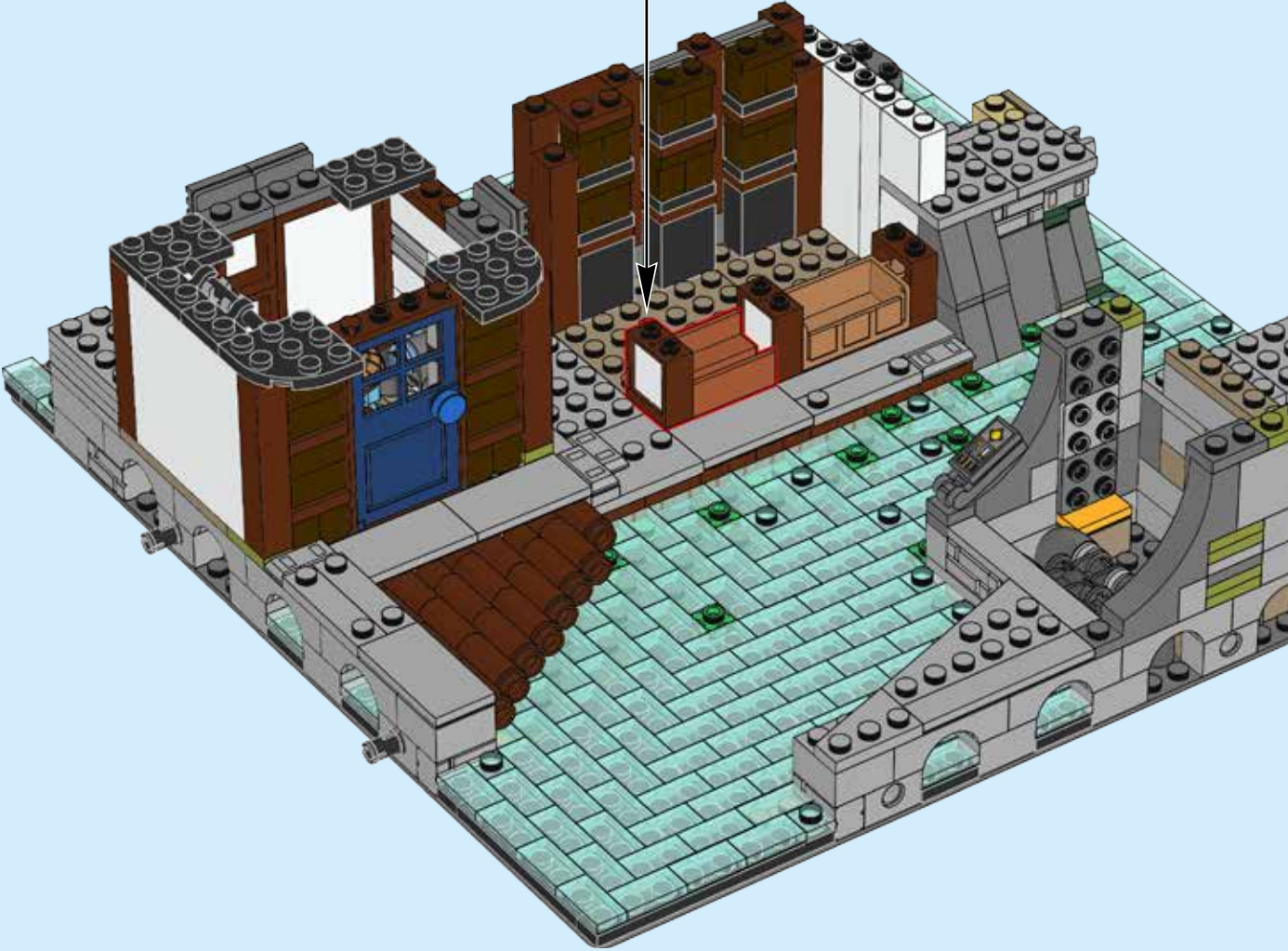
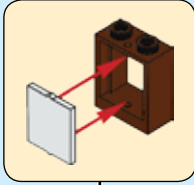

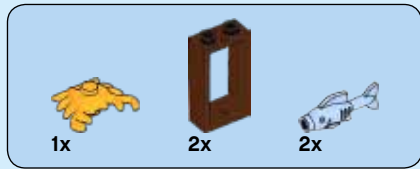



114

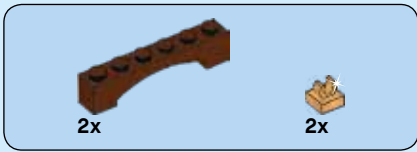



115



3x  1x 

116

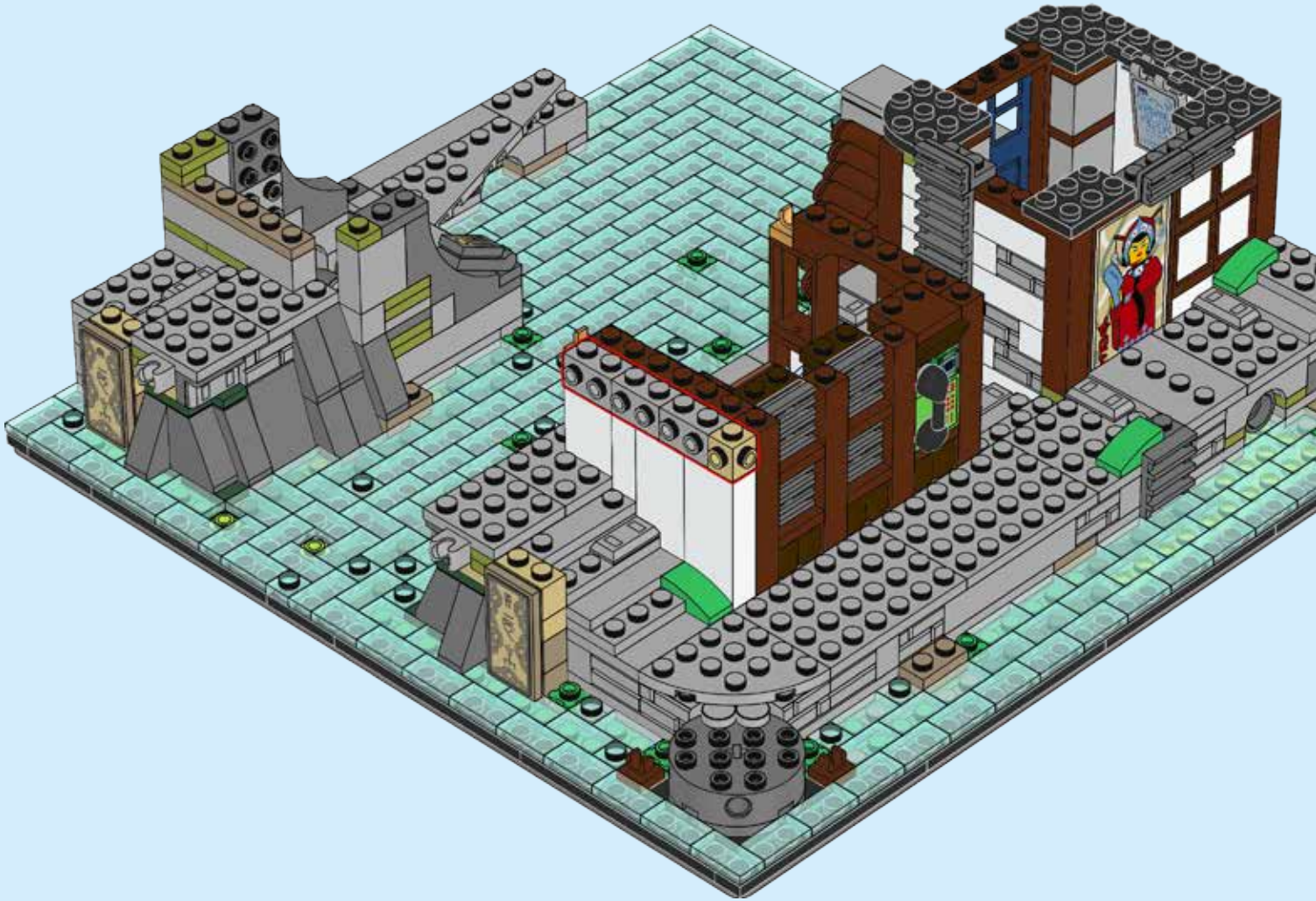

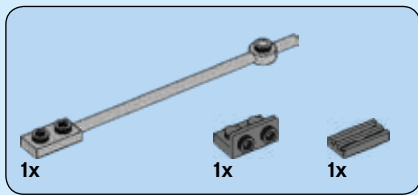

117

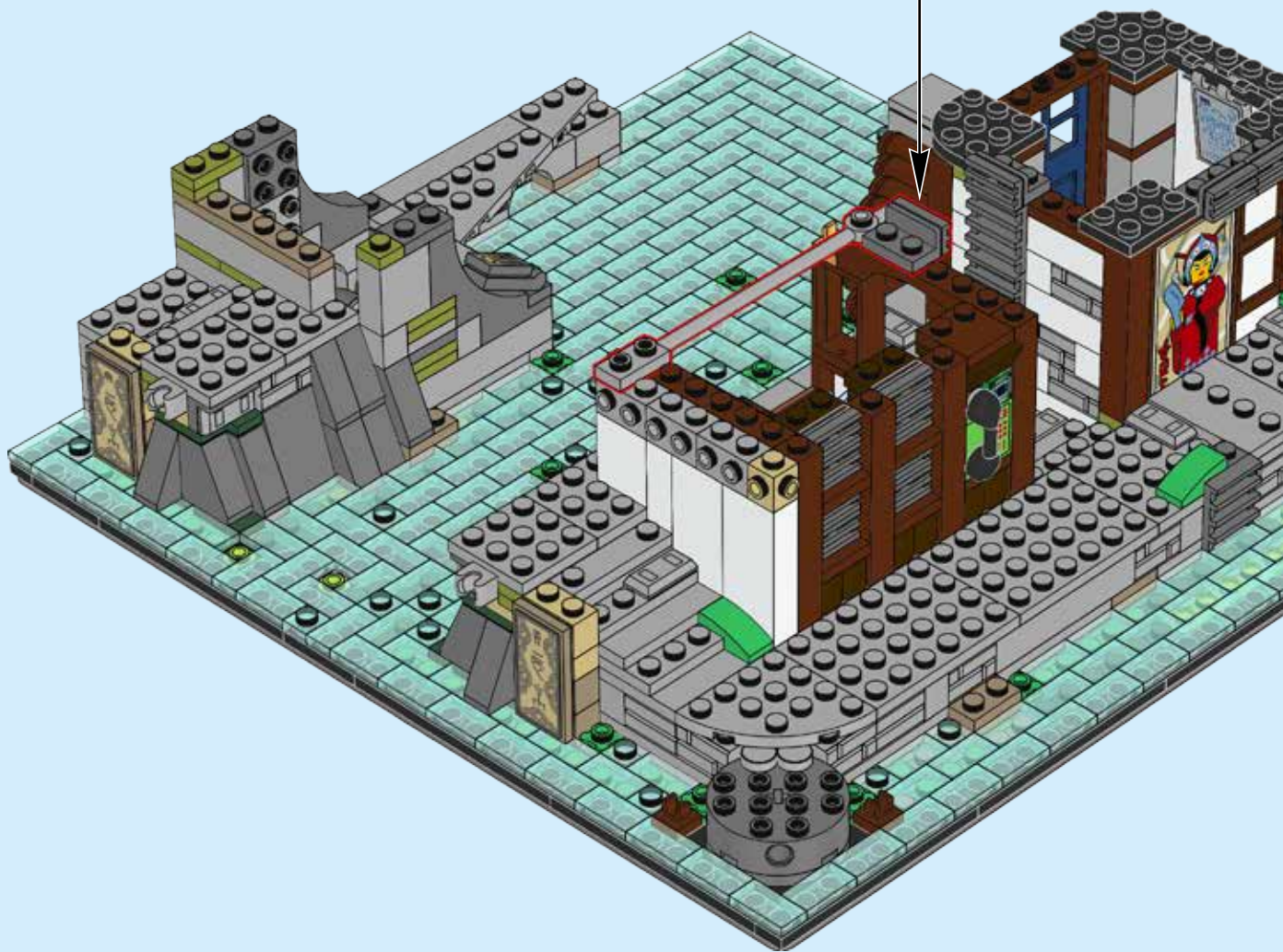
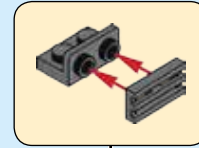

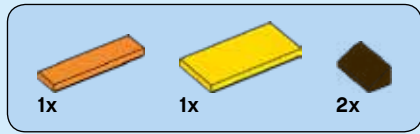

118

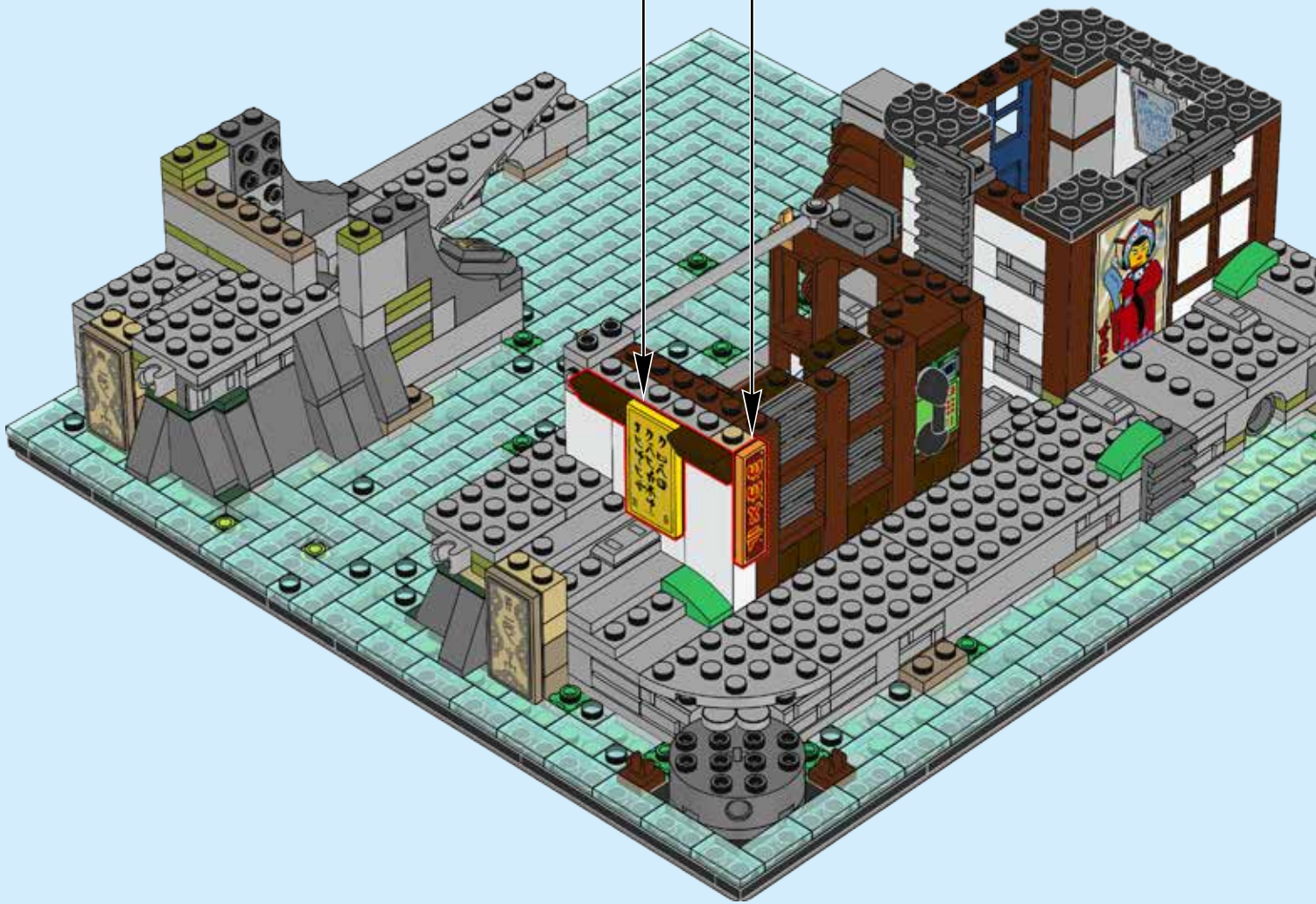
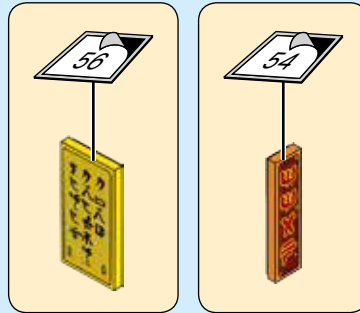

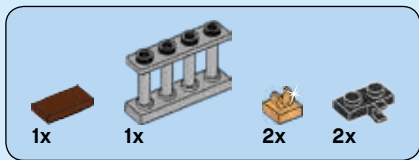

119

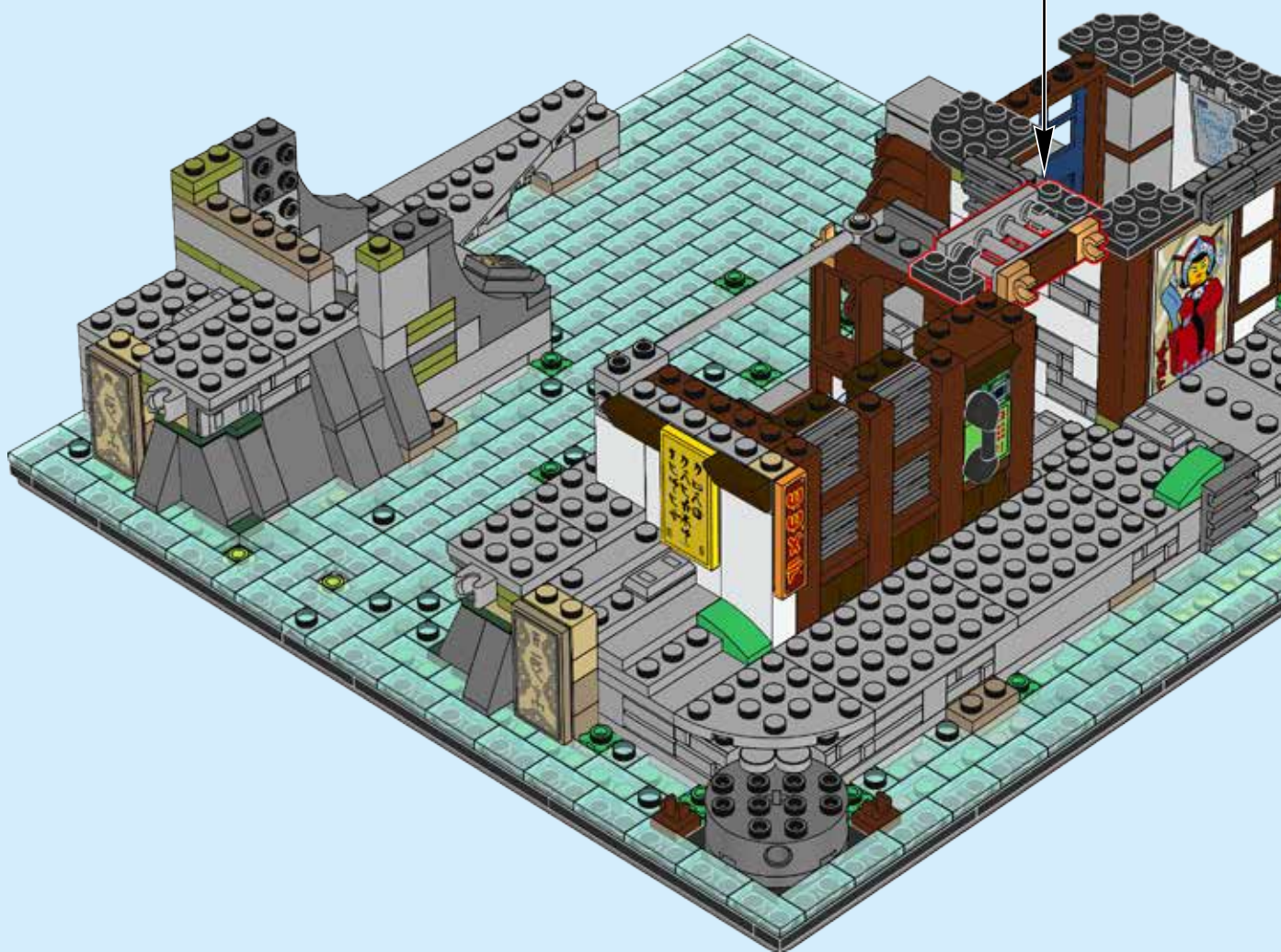
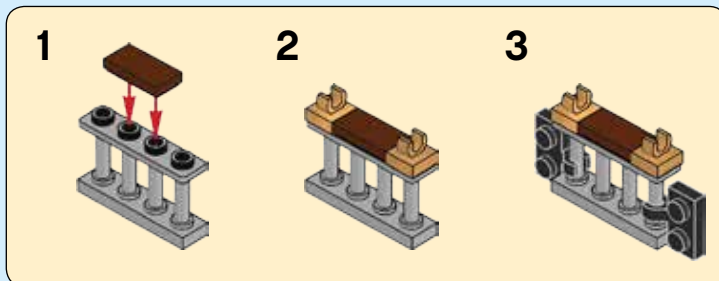

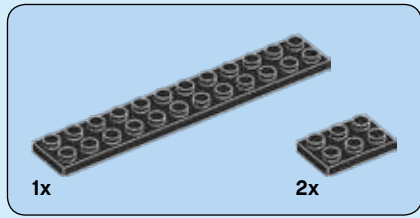

120



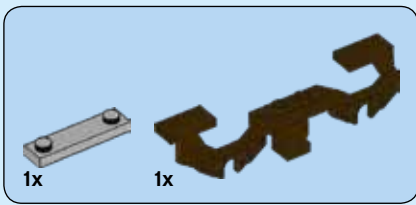

121



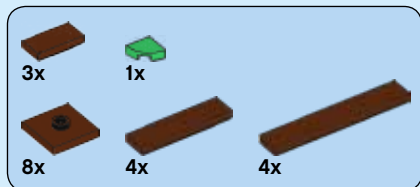

122



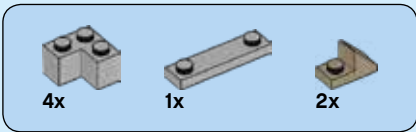

123



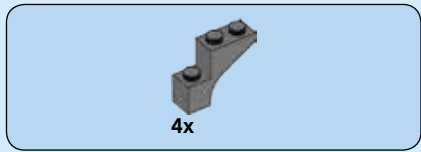

124



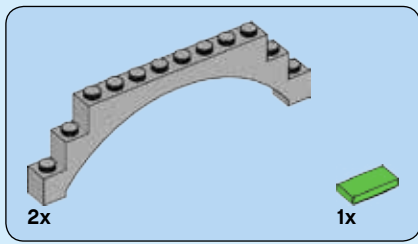

125

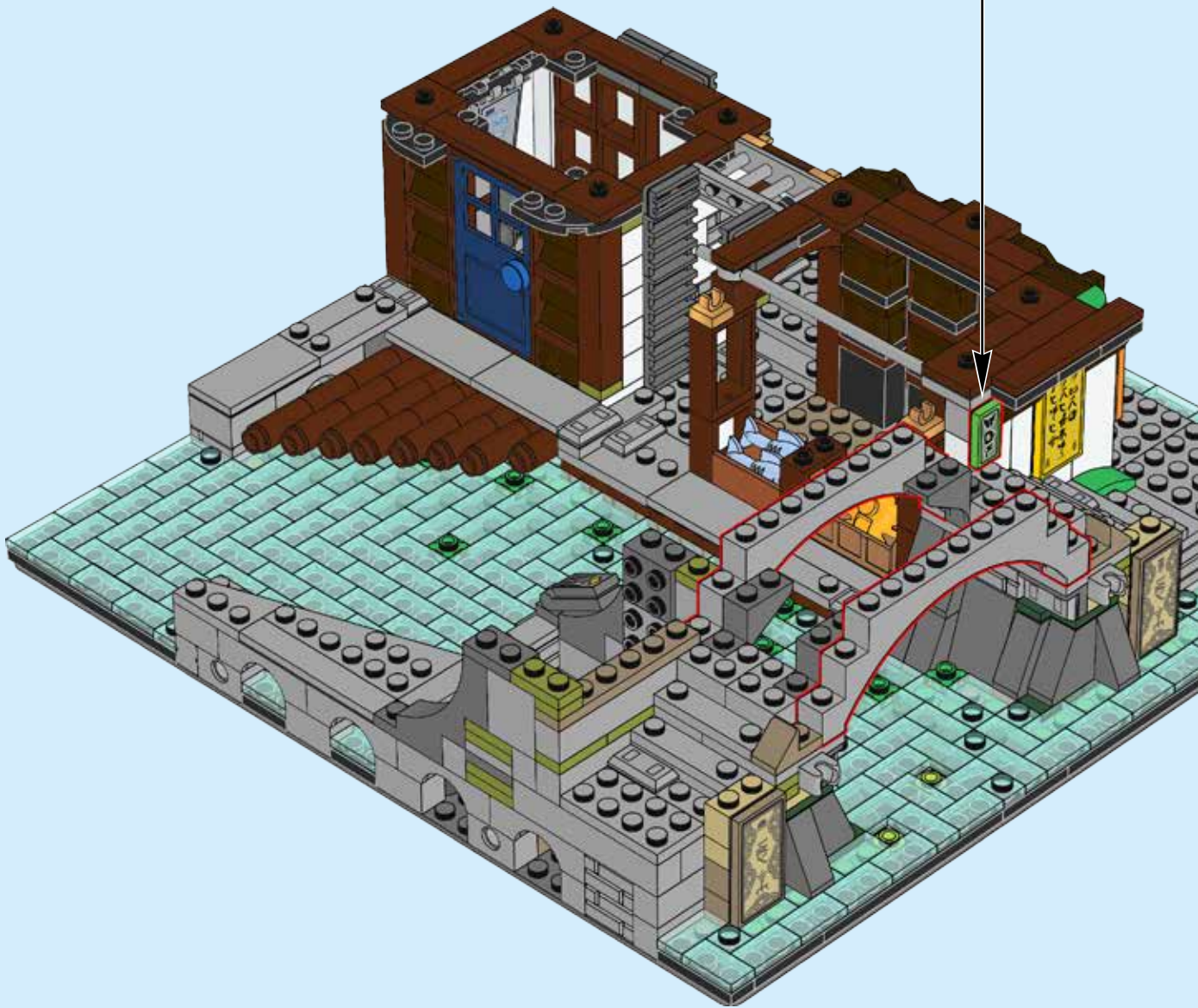
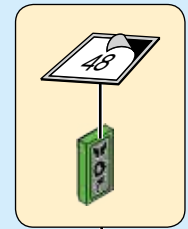

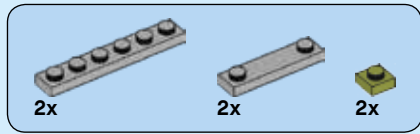

126

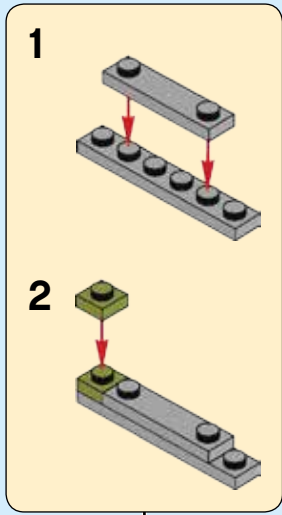
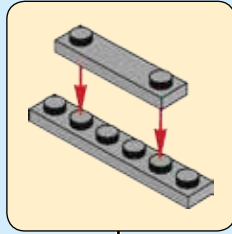

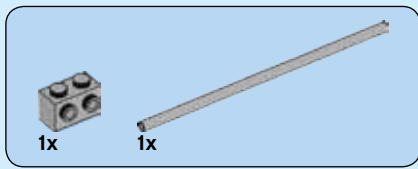

127

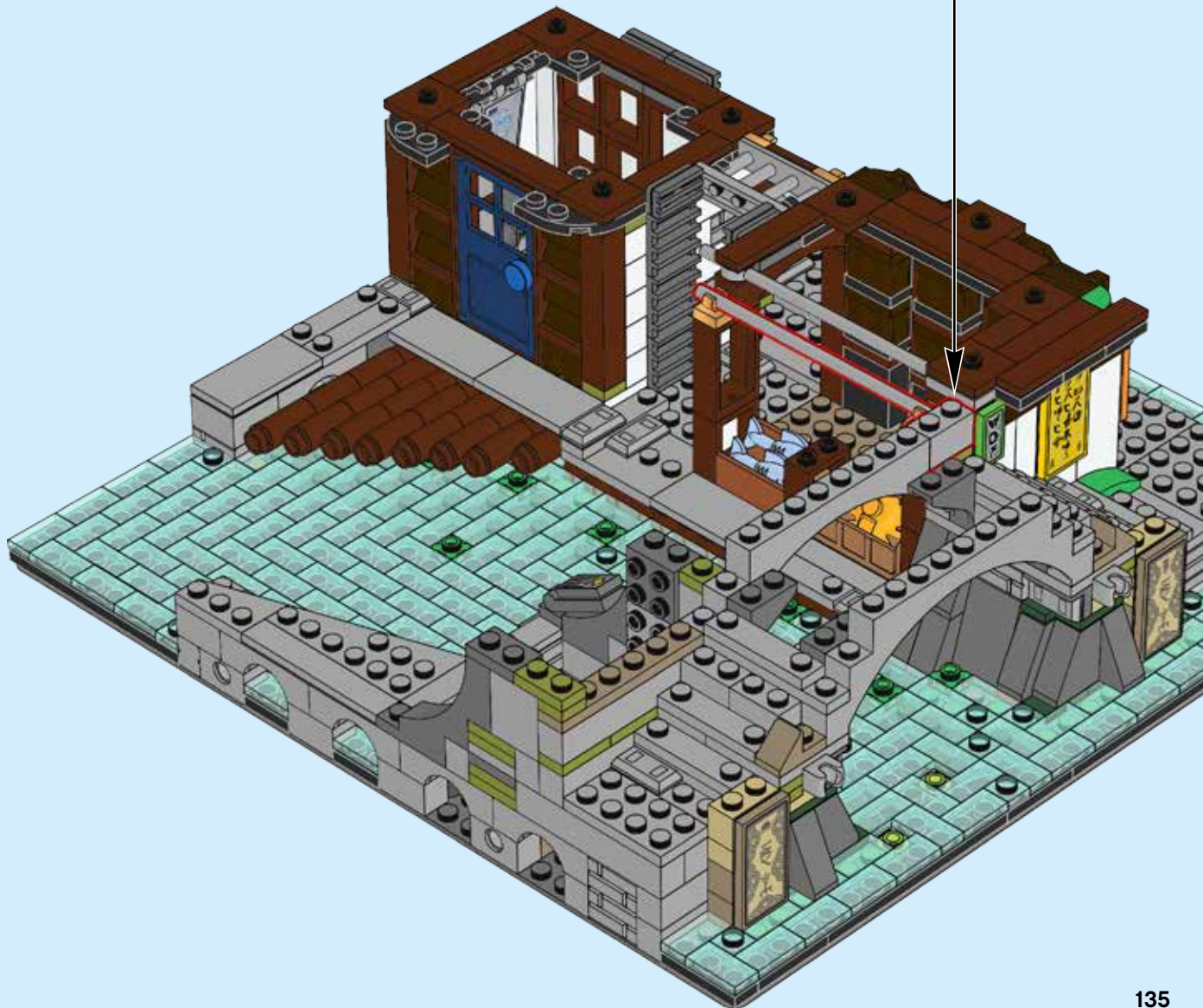
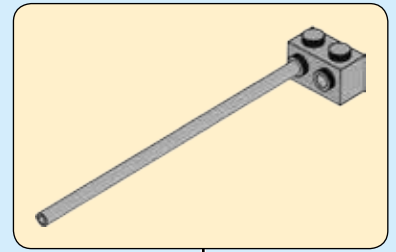

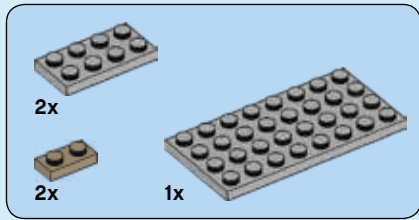

128

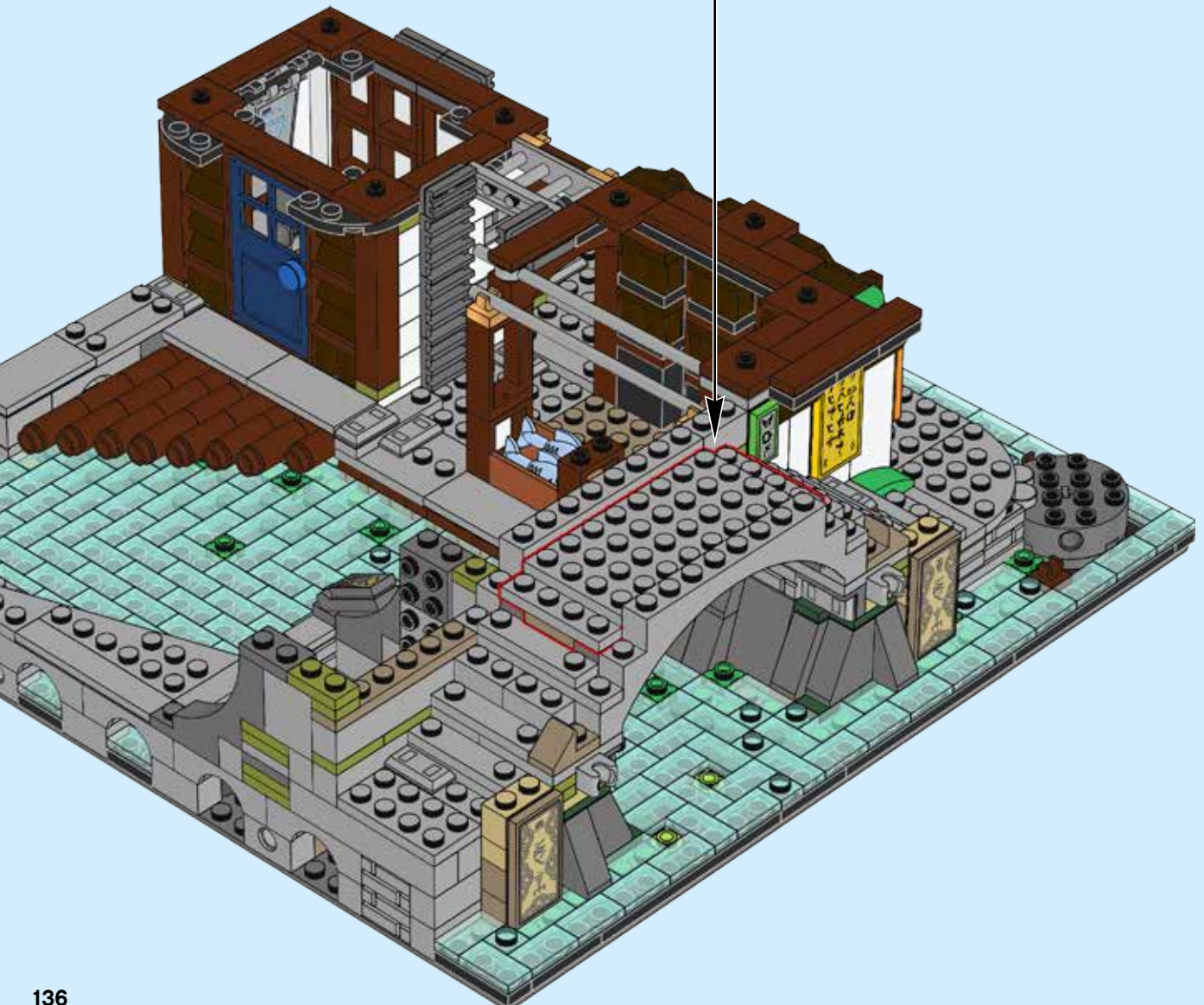
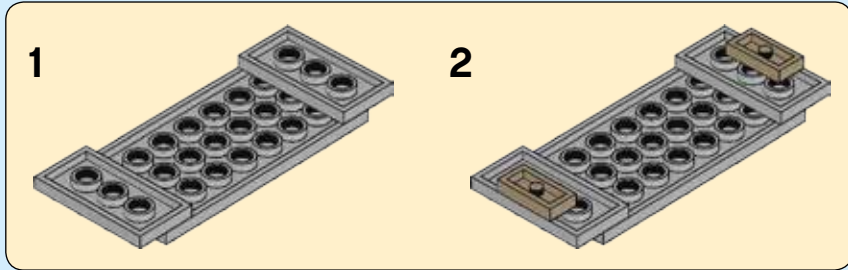



129

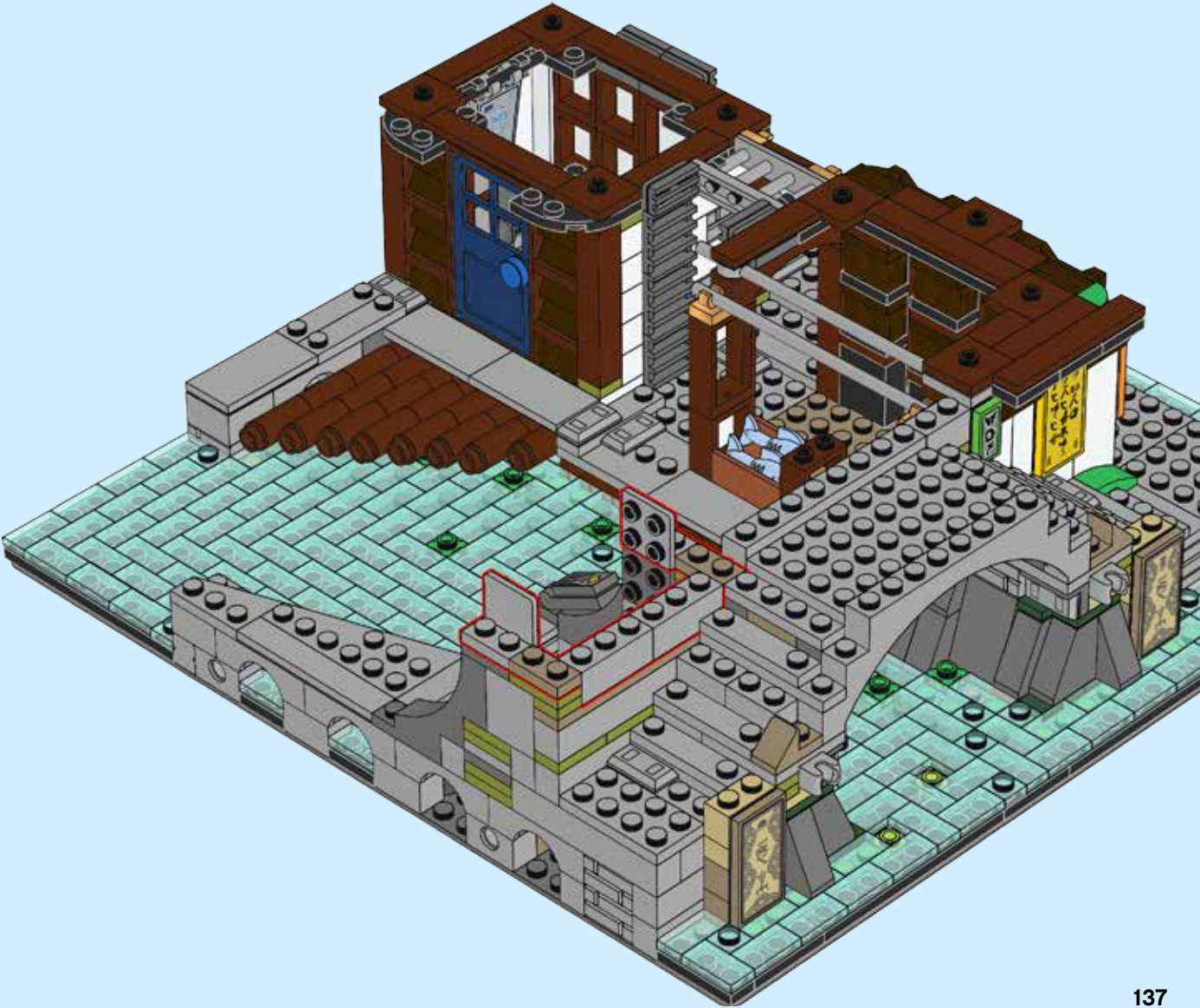

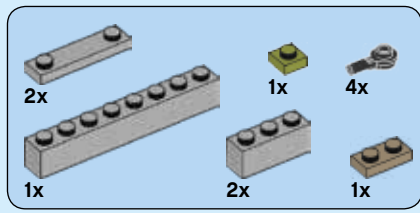

130



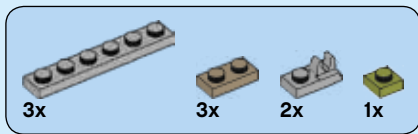

131



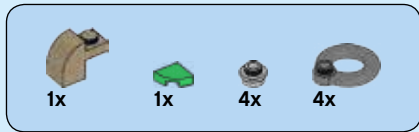

132

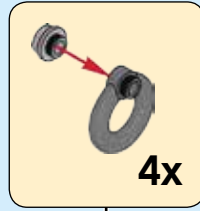

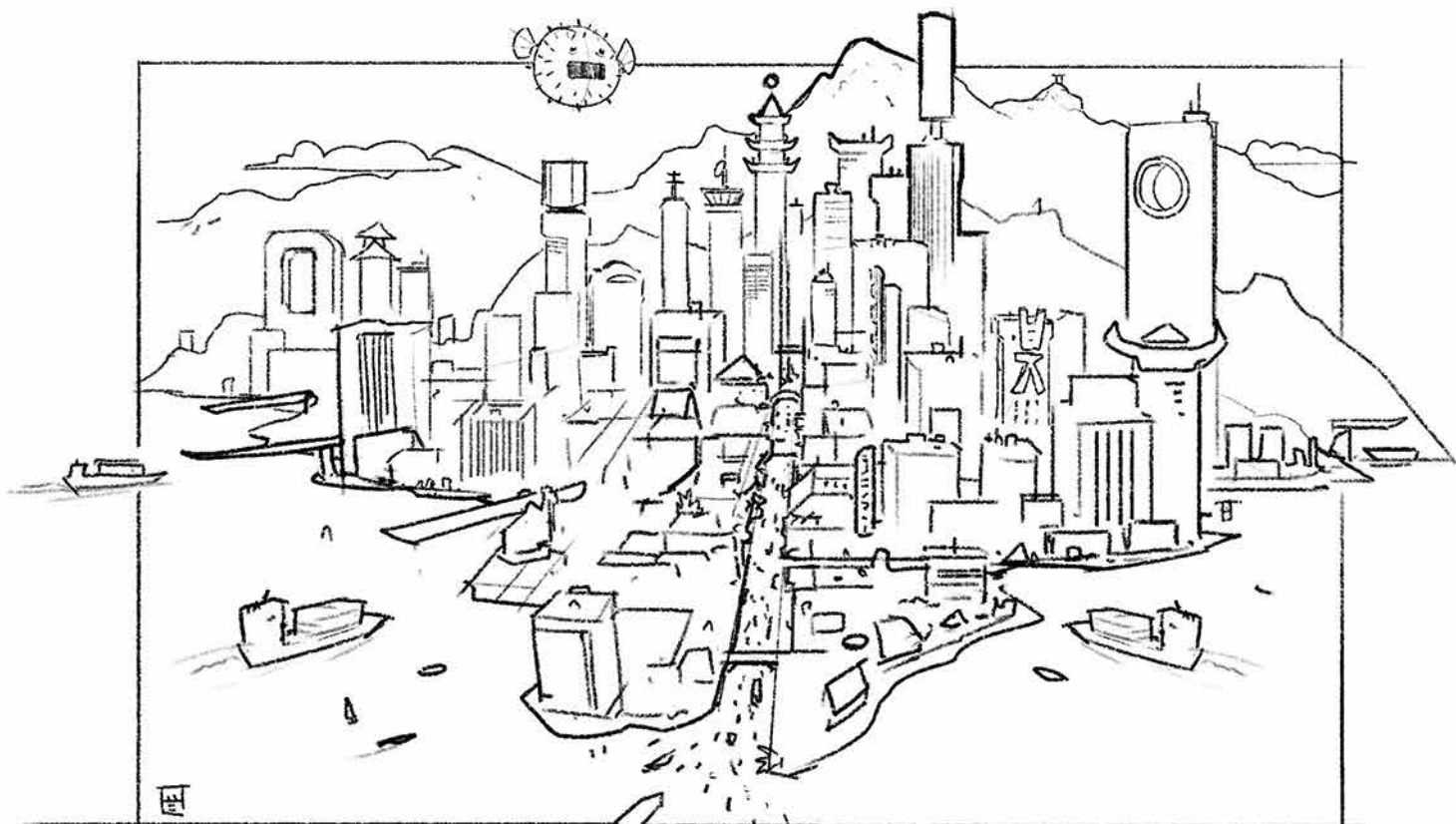

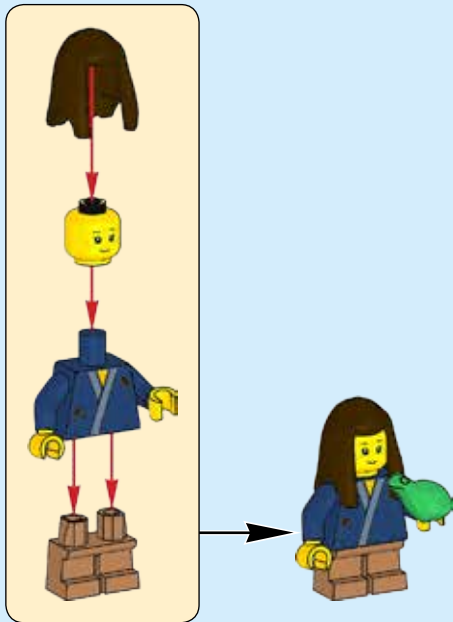

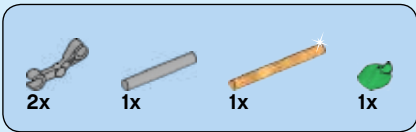

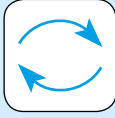
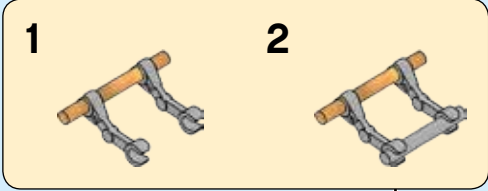

133



2x  19x 

134



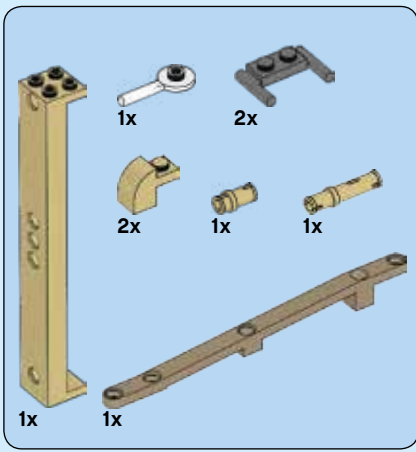

135

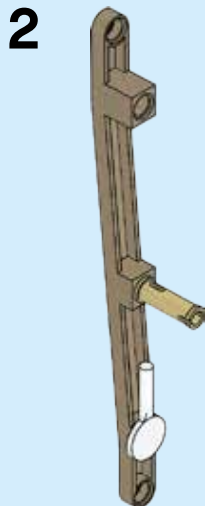
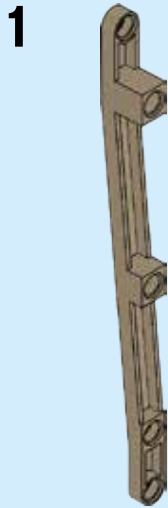

3

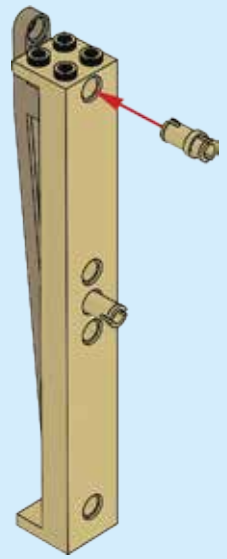

4

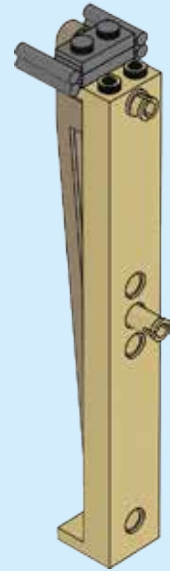

5

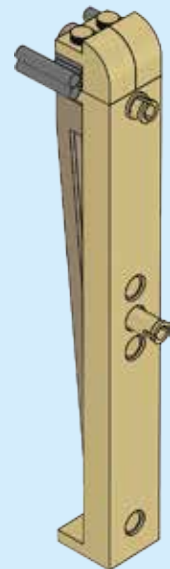





136



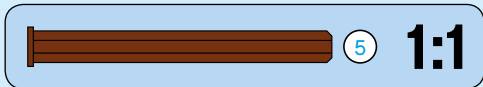
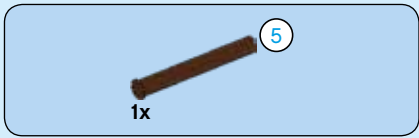

137



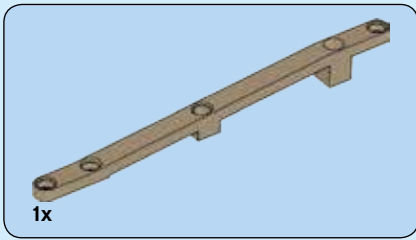

138



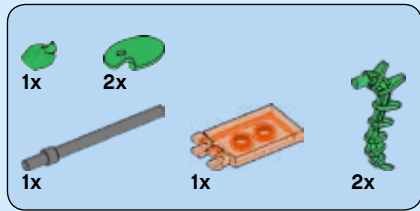

139

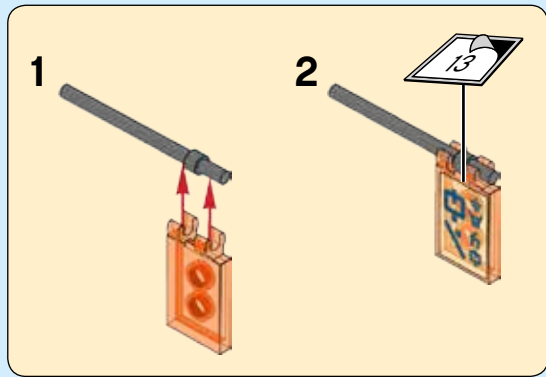



140

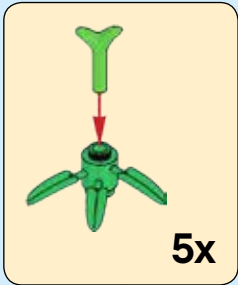

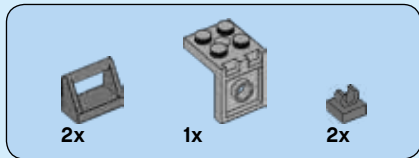

141

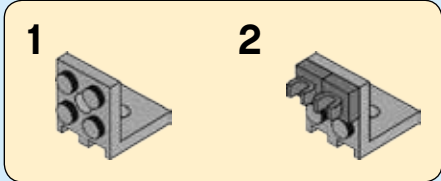

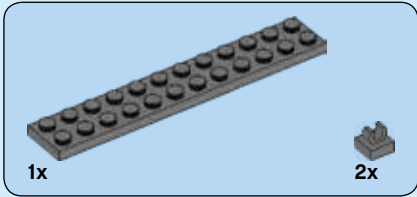
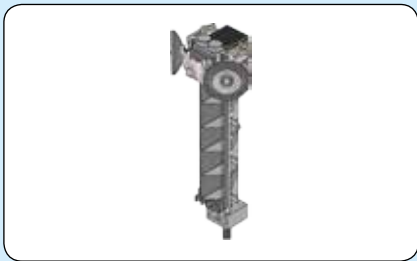

142

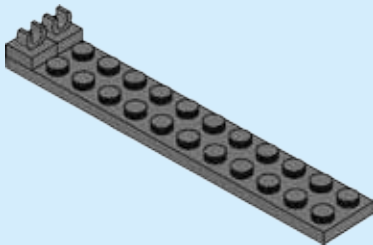

143

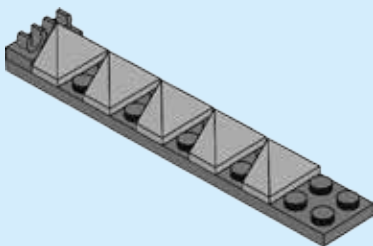

144

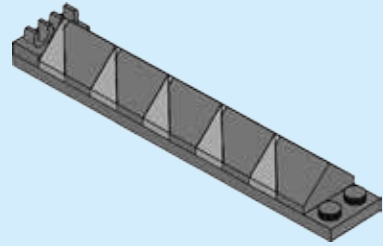

145

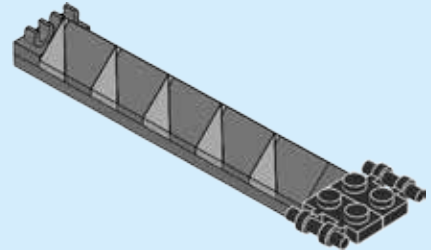

146

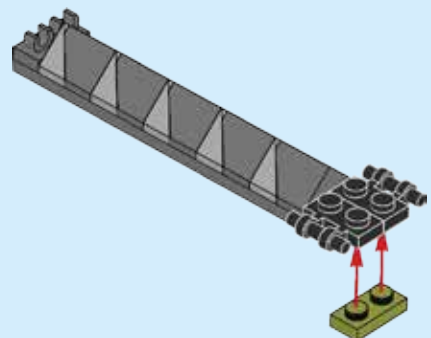



147

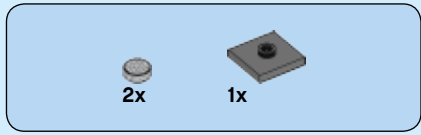
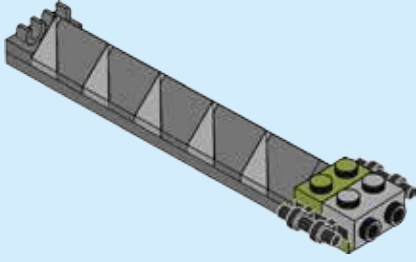

148

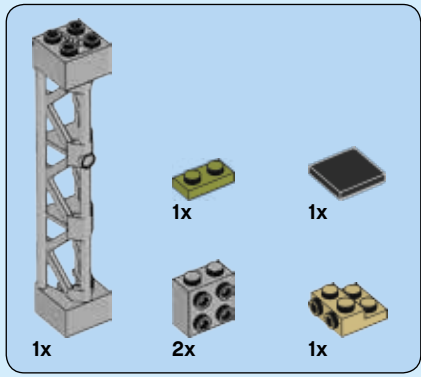
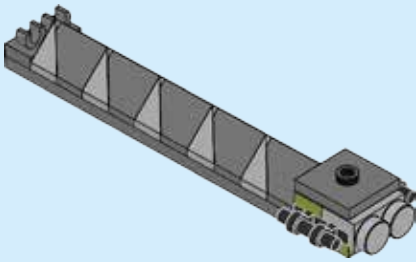

149

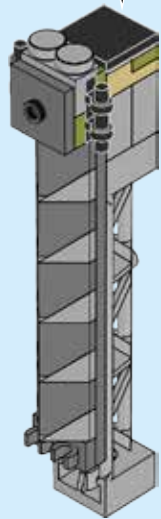
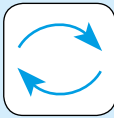
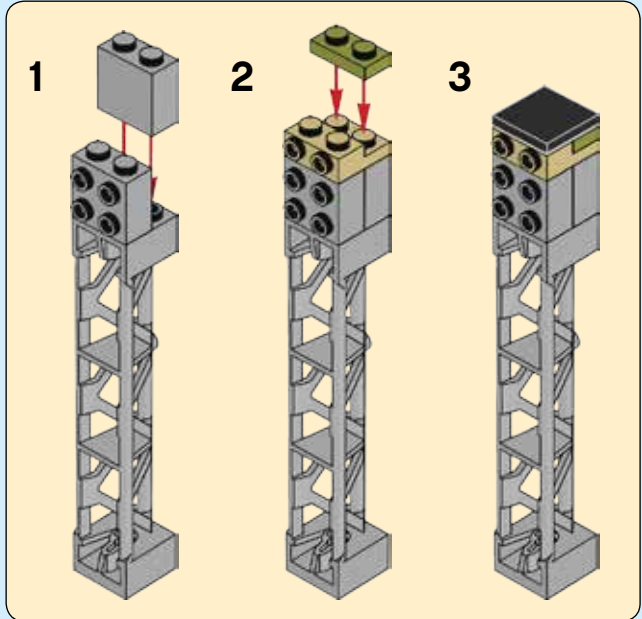

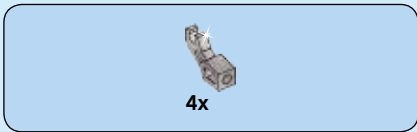

150

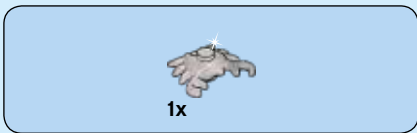
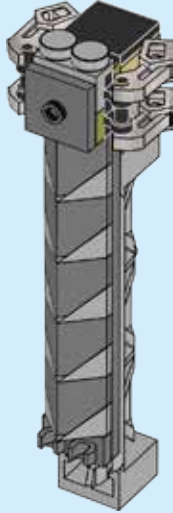

151

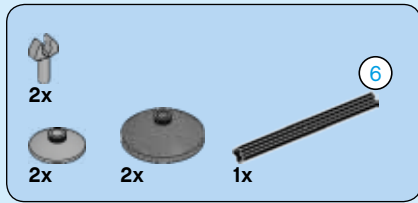
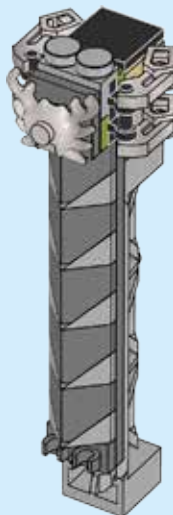

152

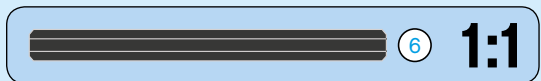
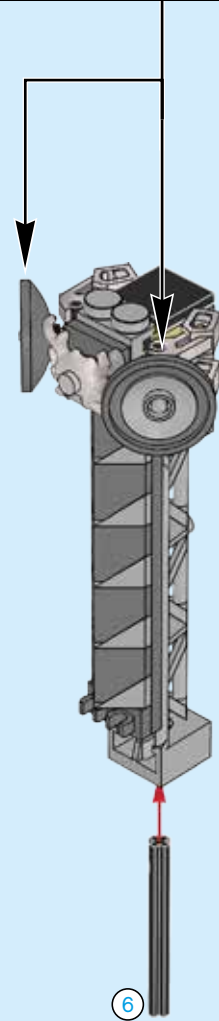
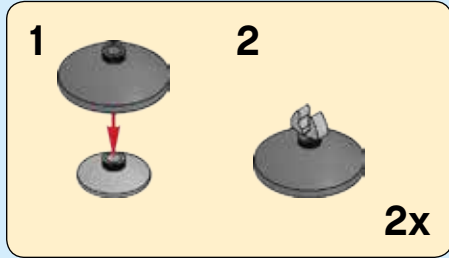

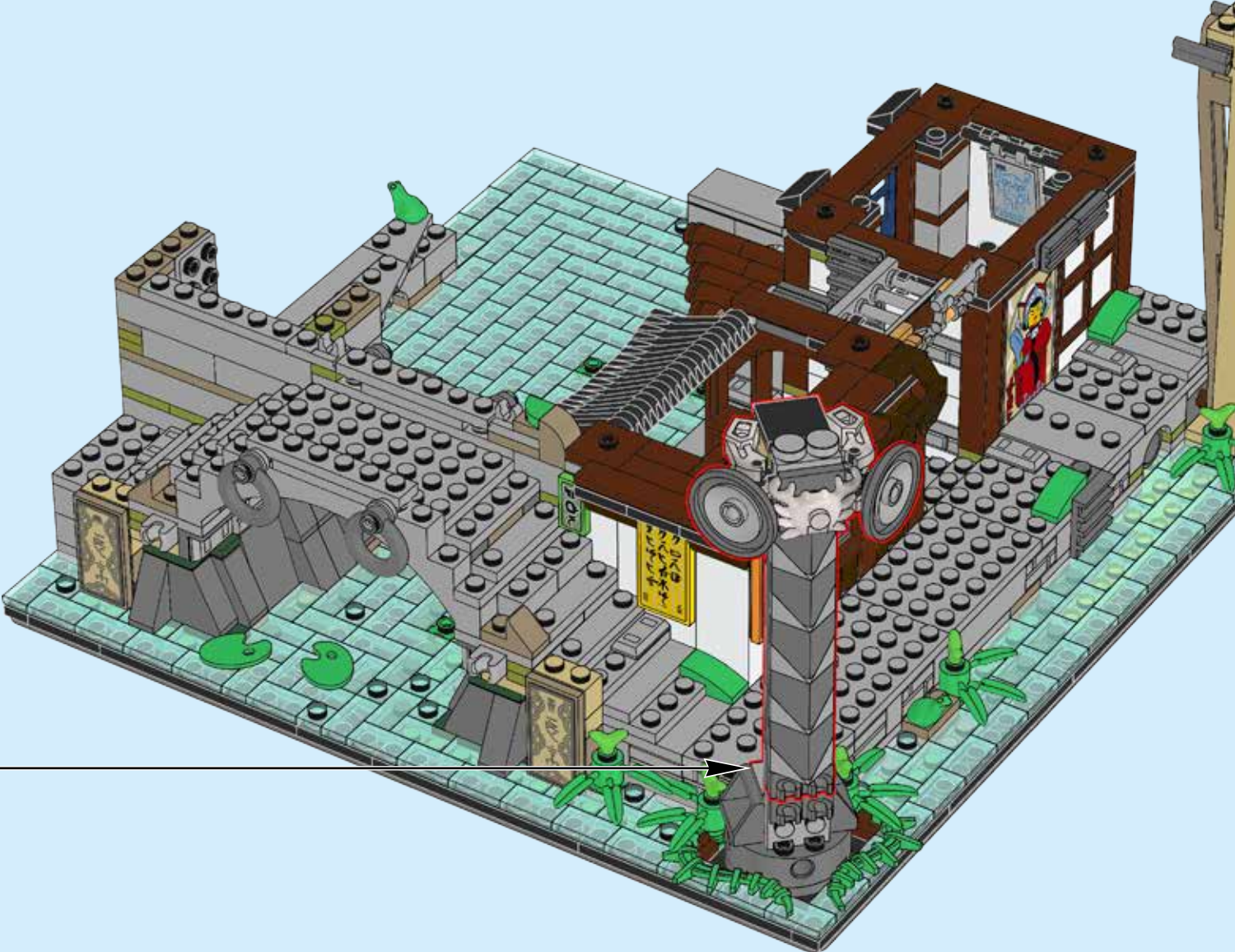

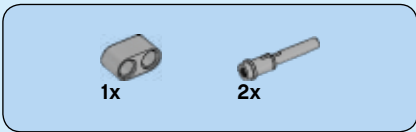

154

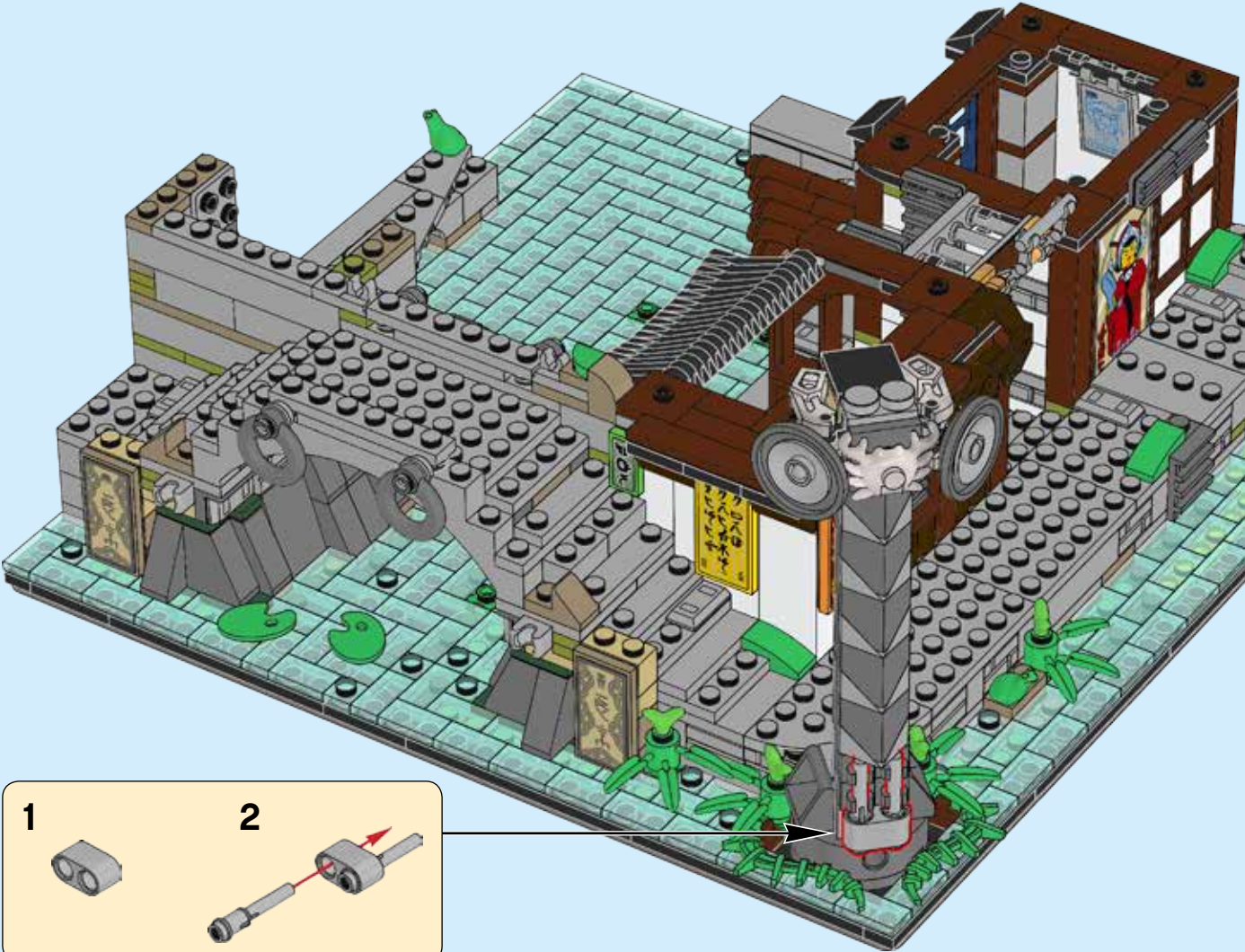

8x 2x 2x

155

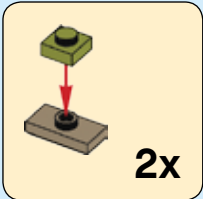

2x

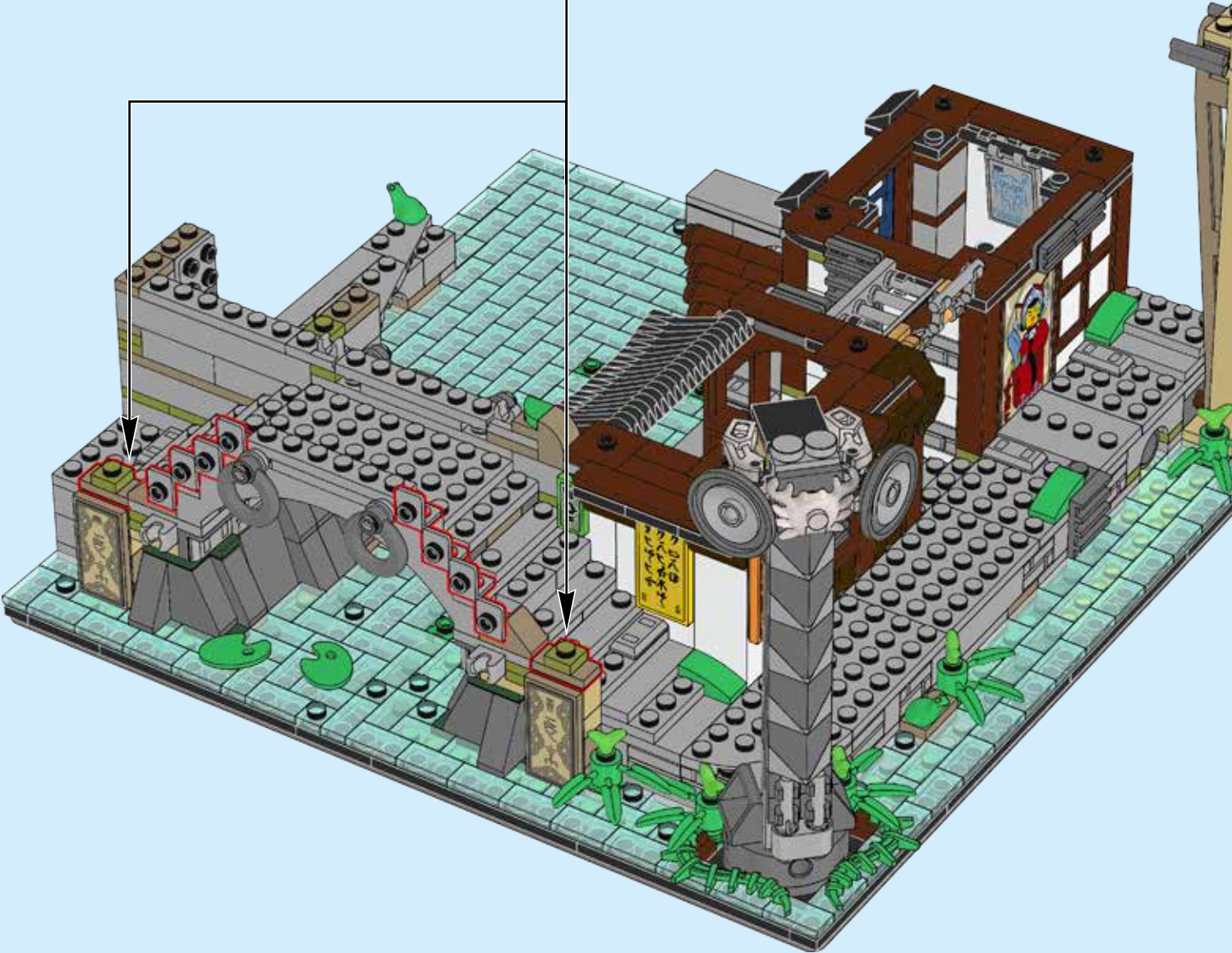



156

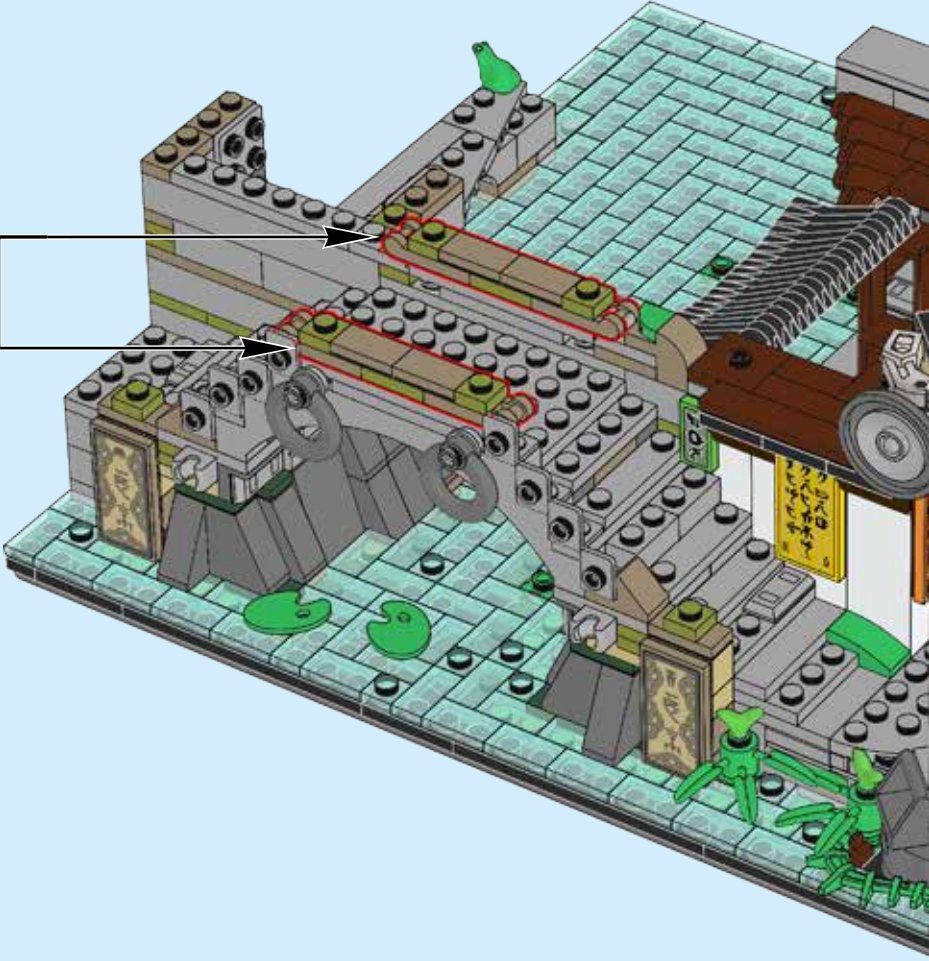
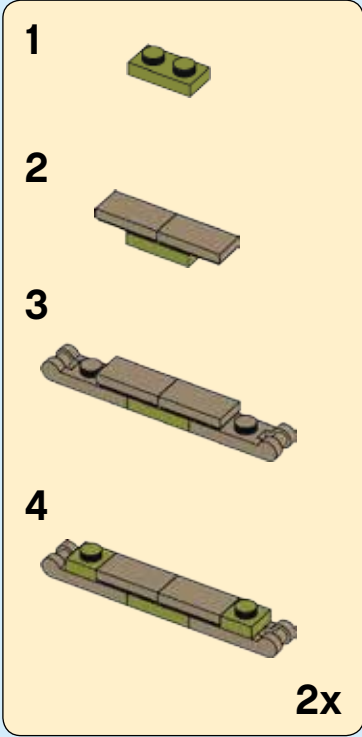

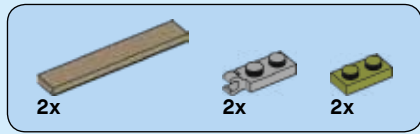

157

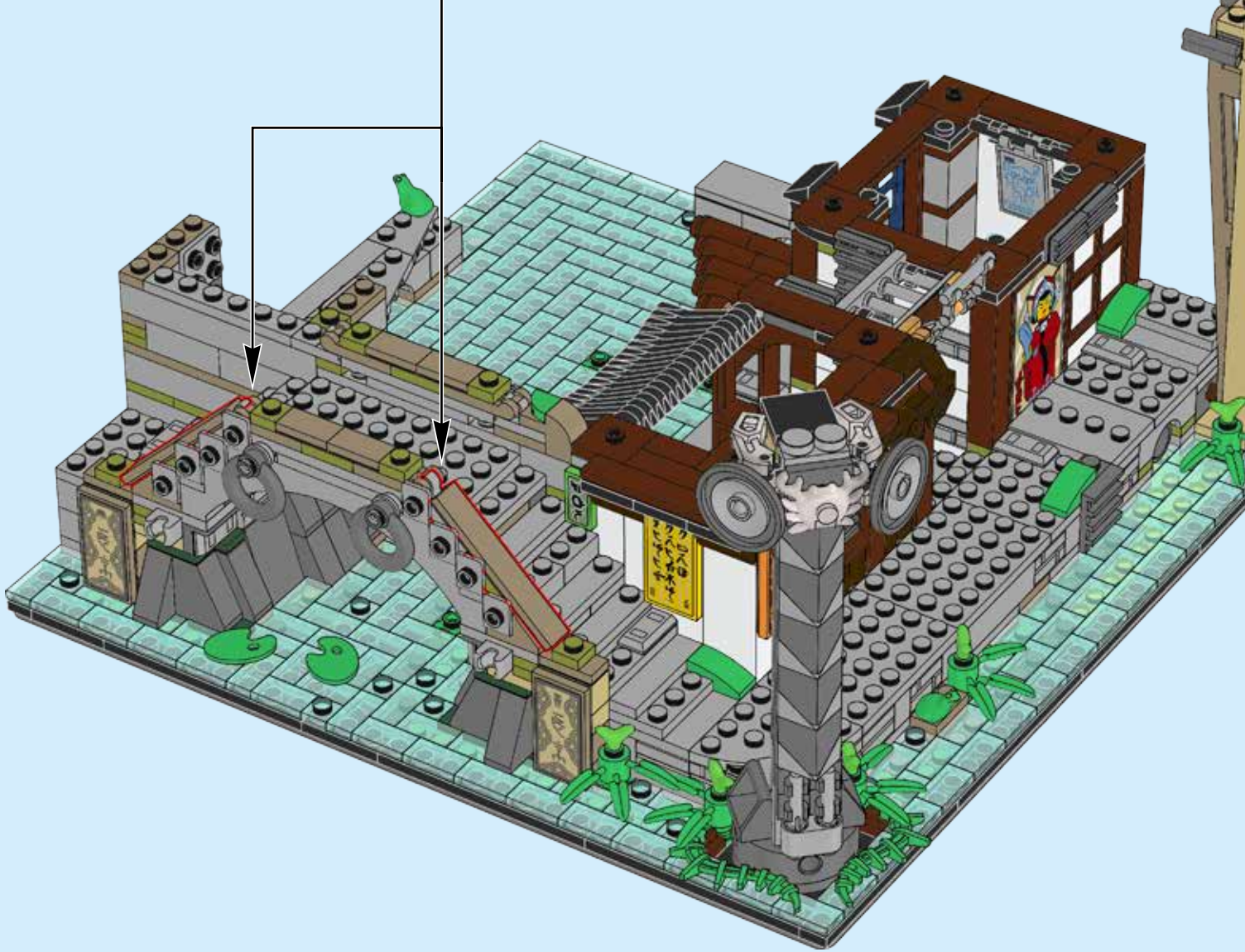
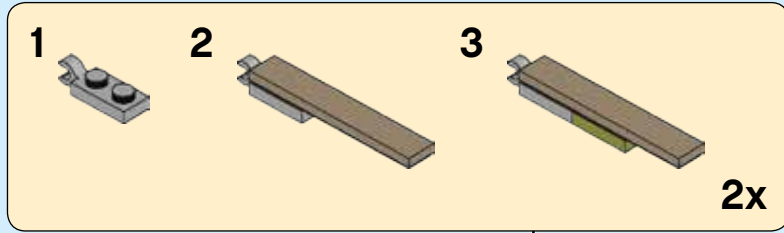

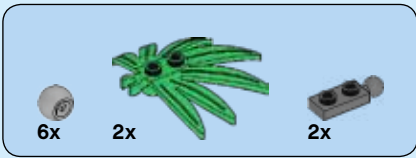

158

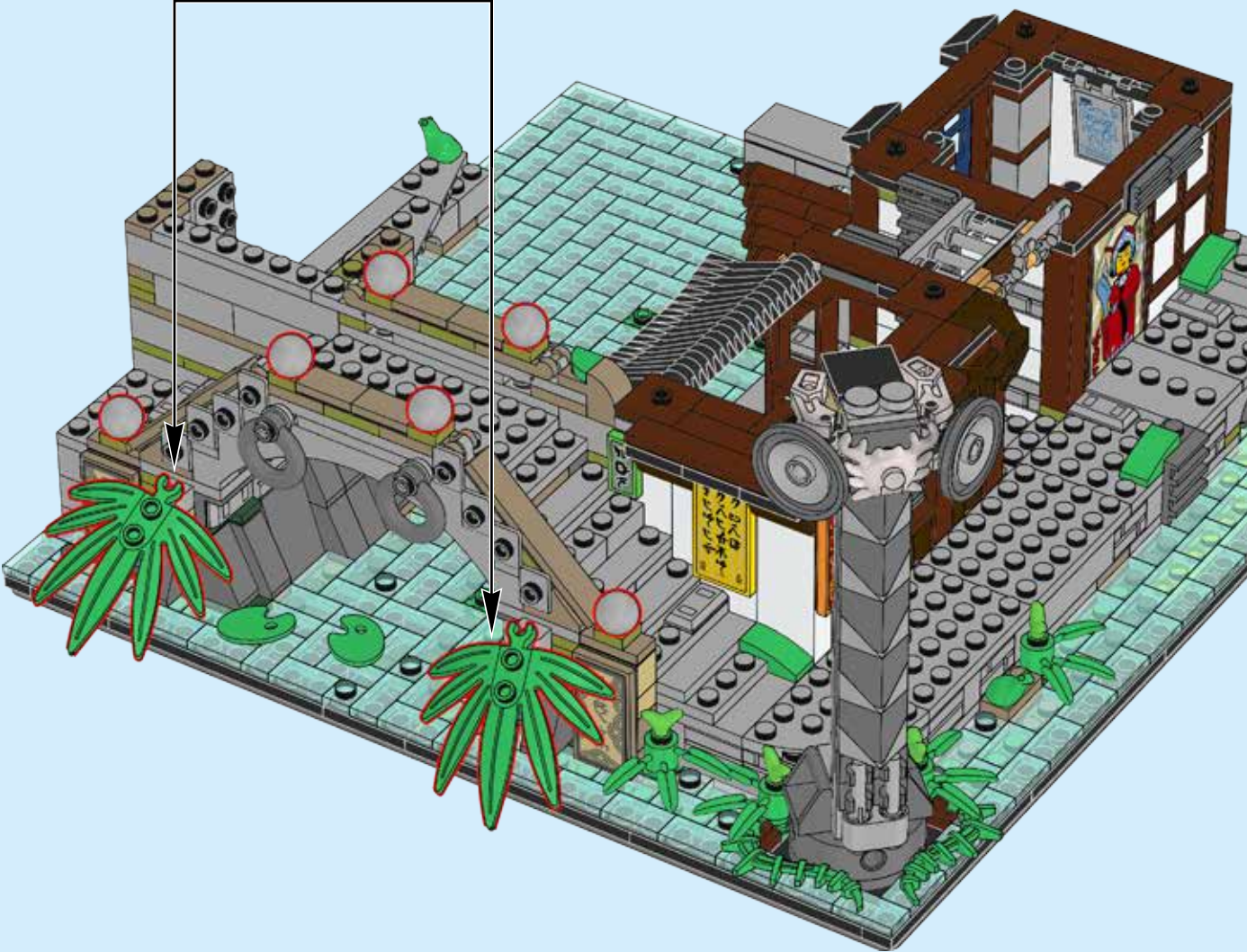
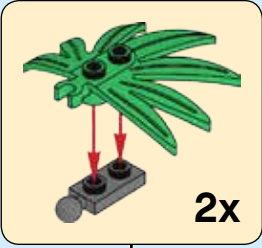

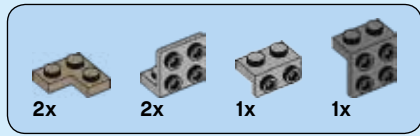

159

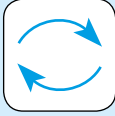



160

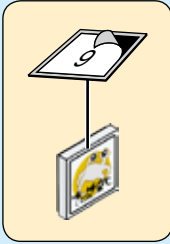
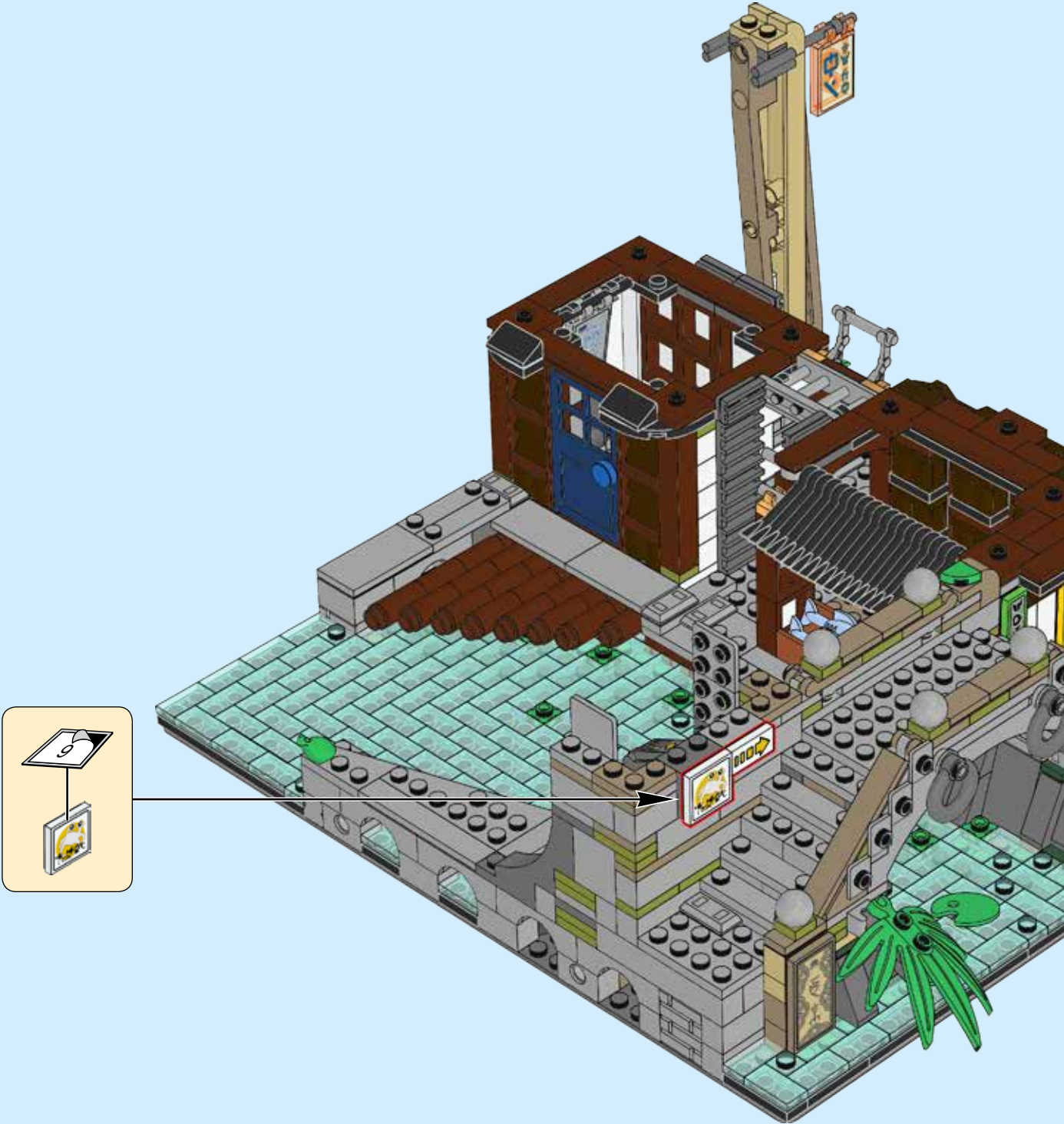

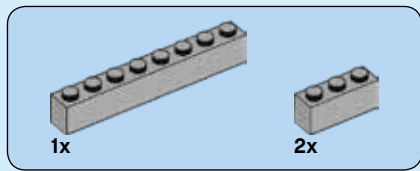

161

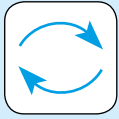

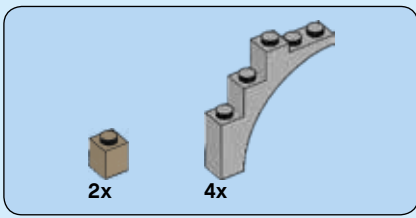

162





163

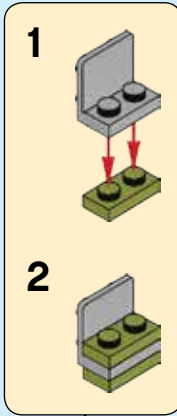
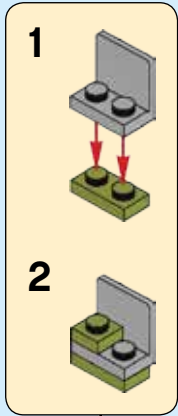

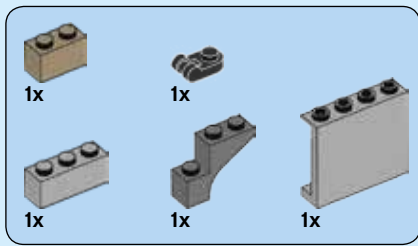

164

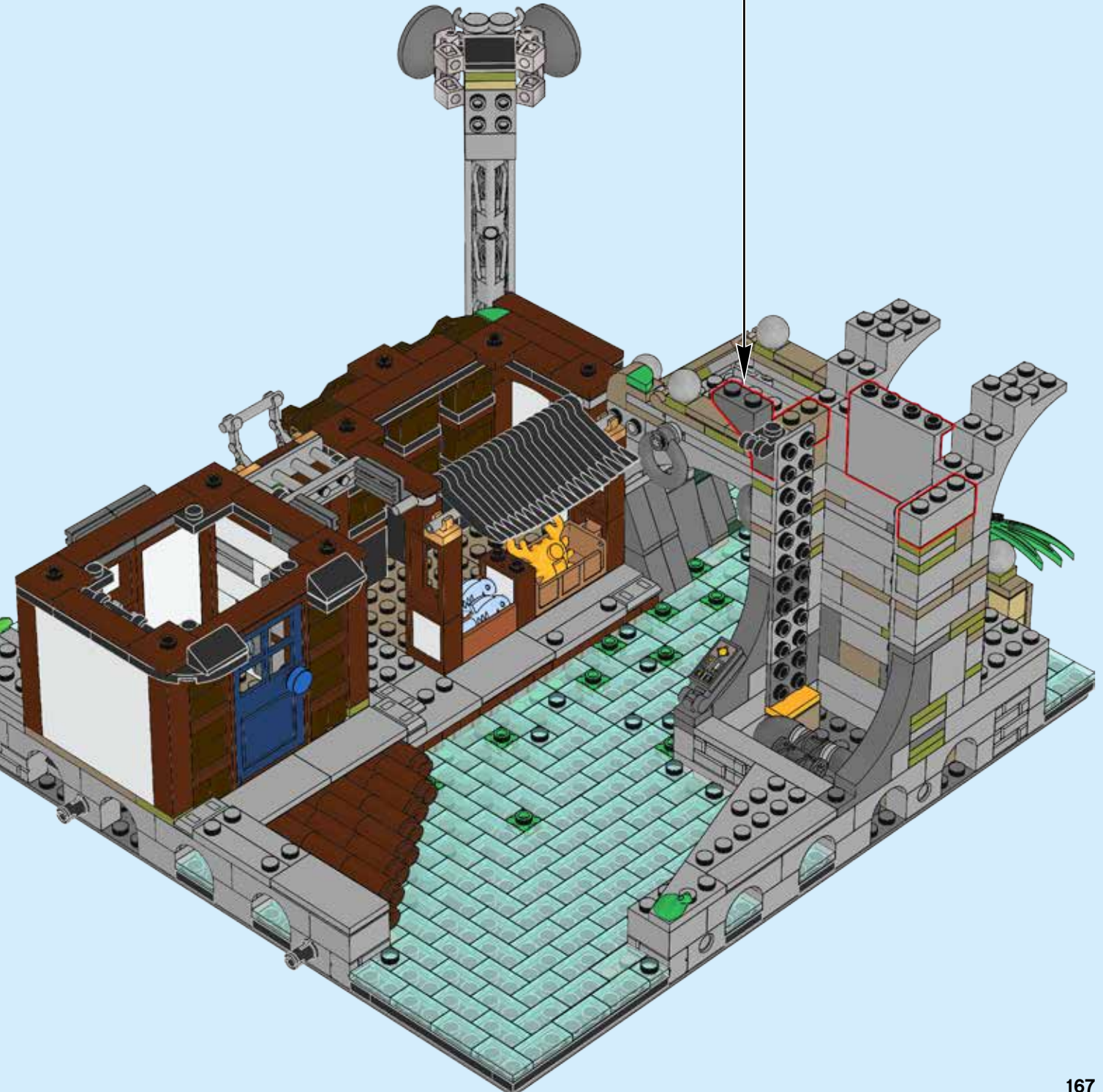
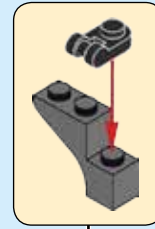

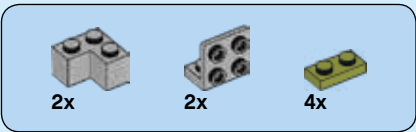

165

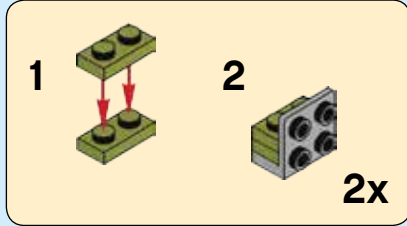

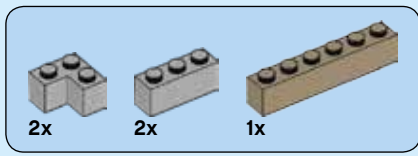

166

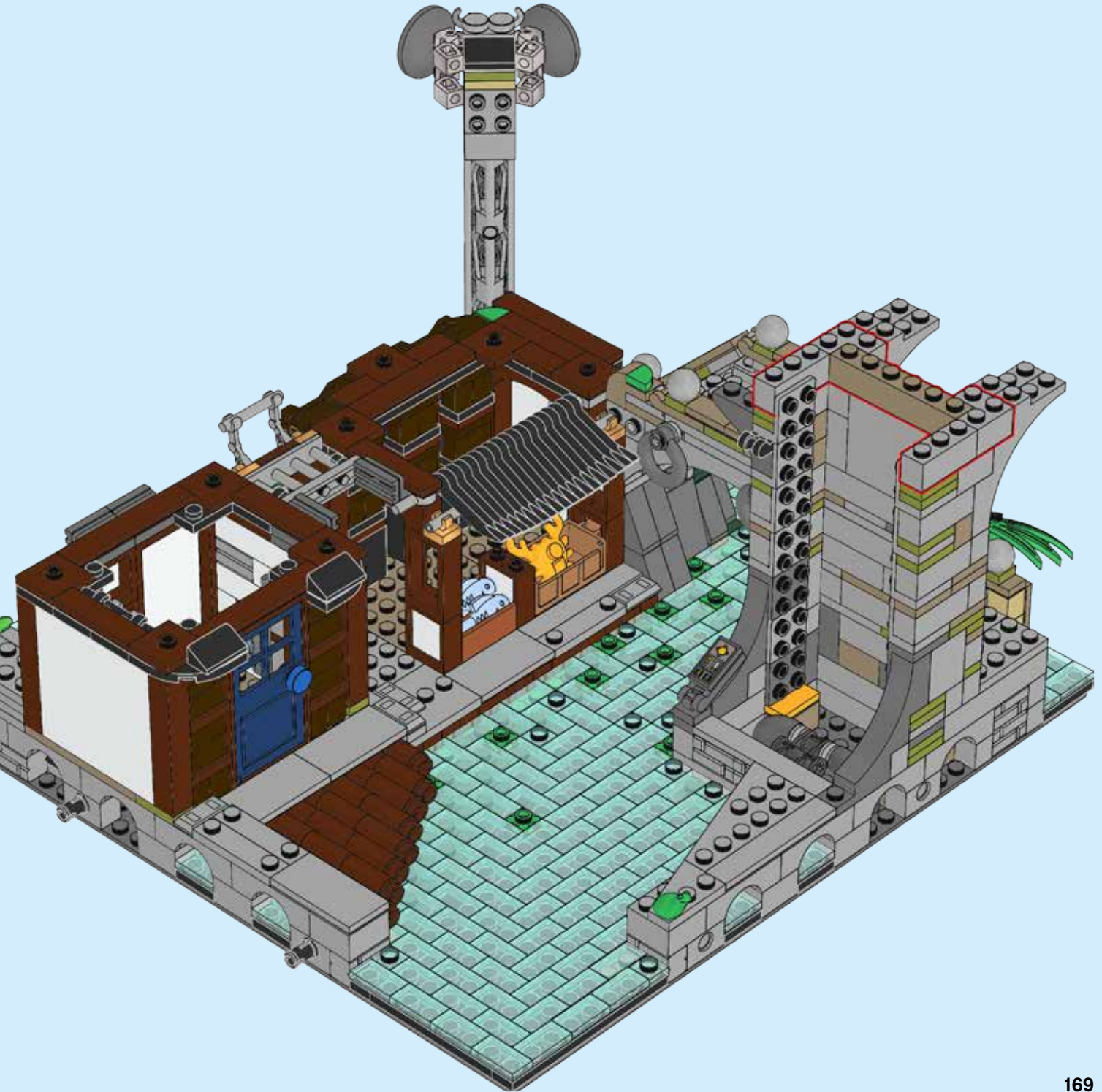



167

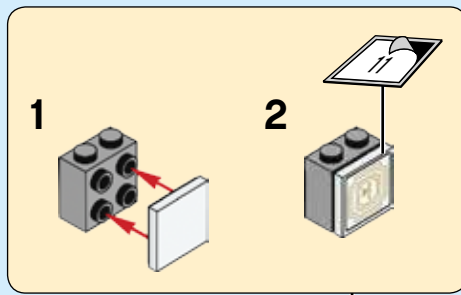

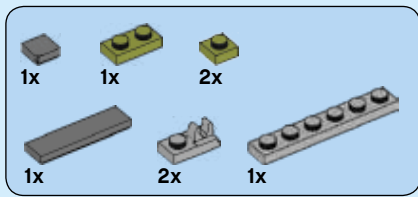

168

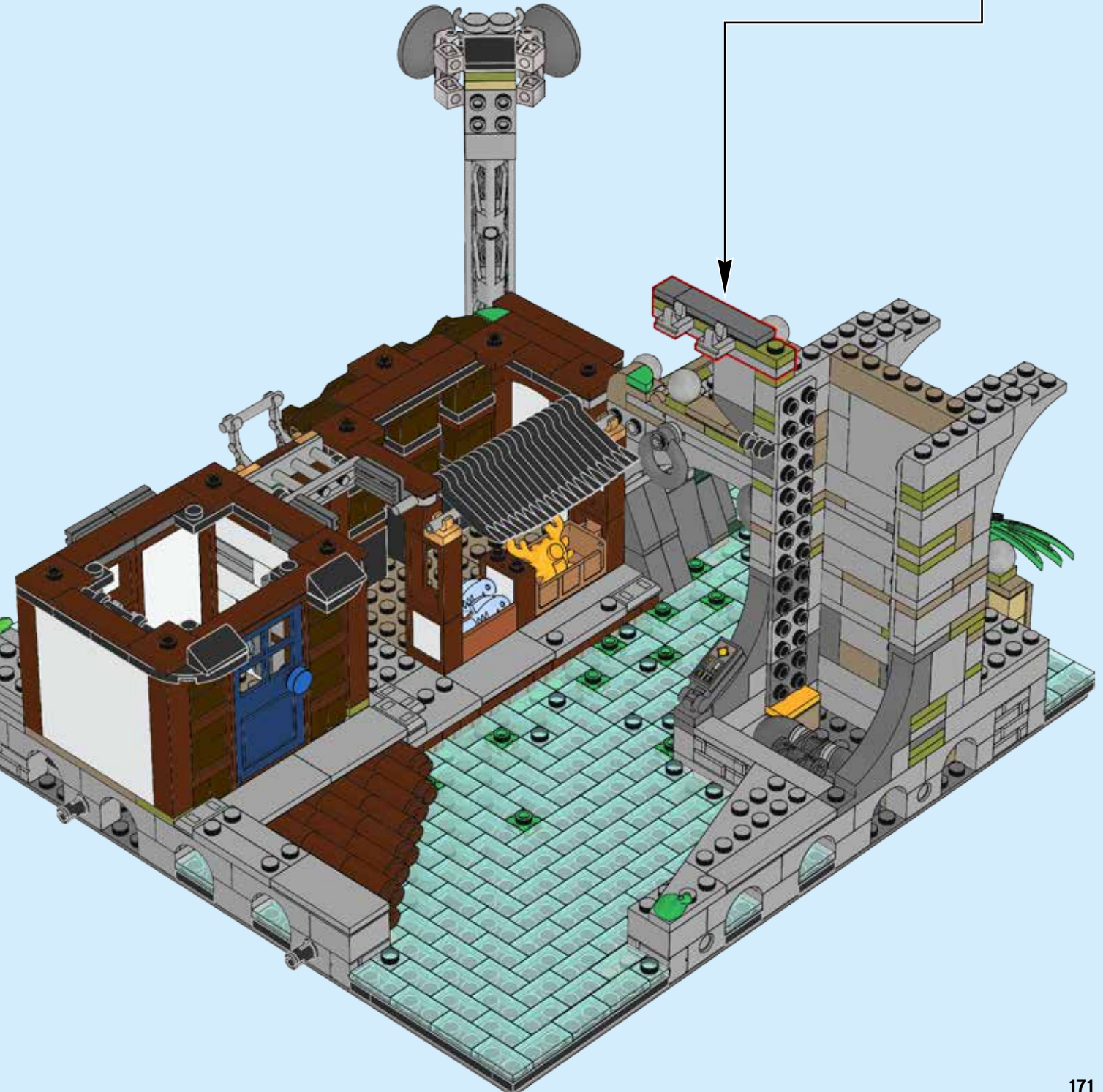
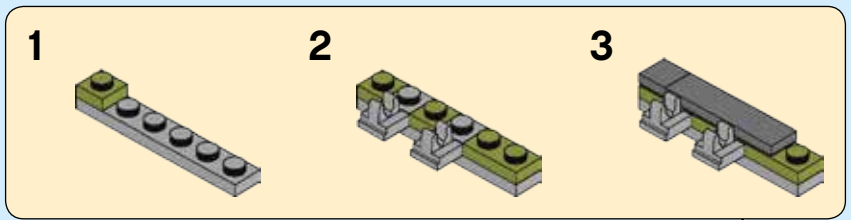

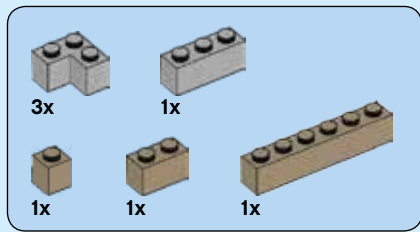

169



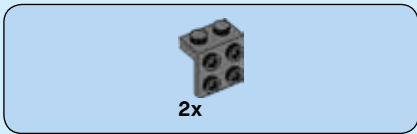

170



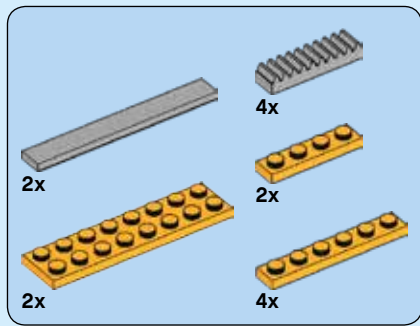

171

1

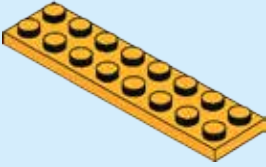

2

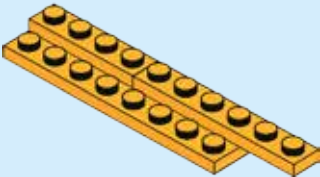

3

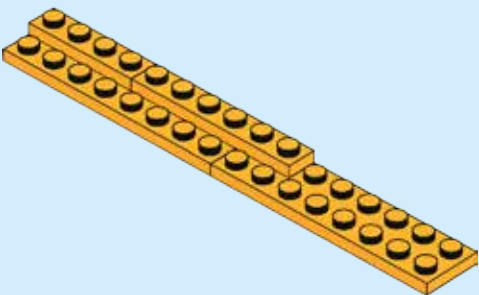

4

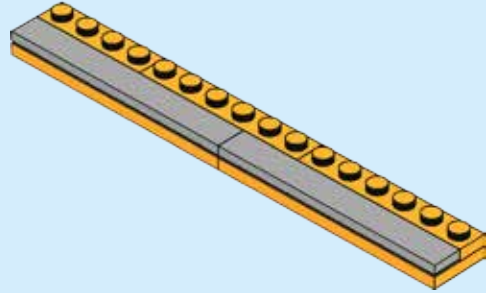

5

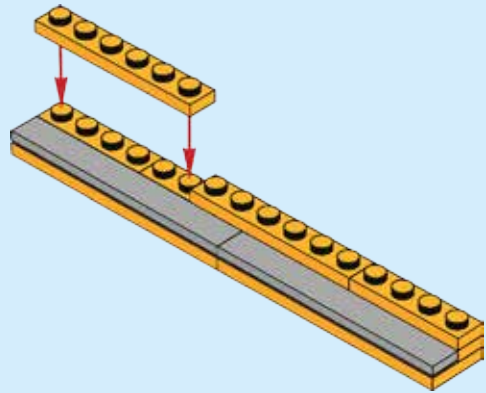

6

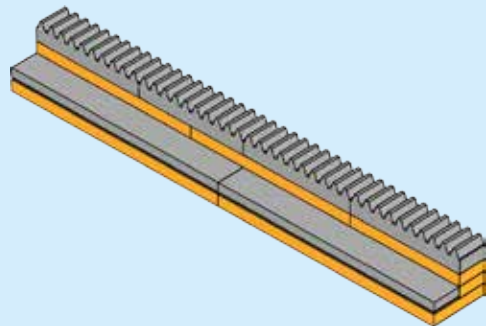



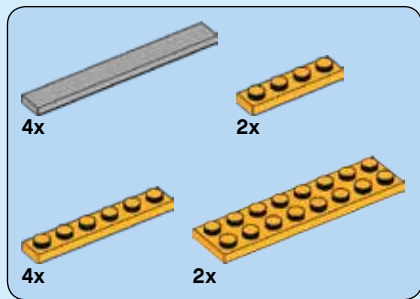

172

1

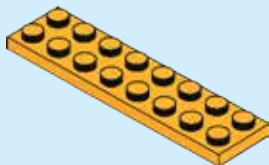

2

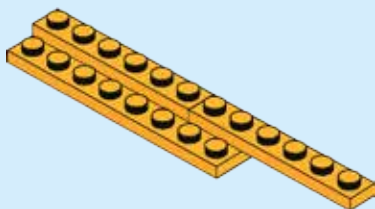

3

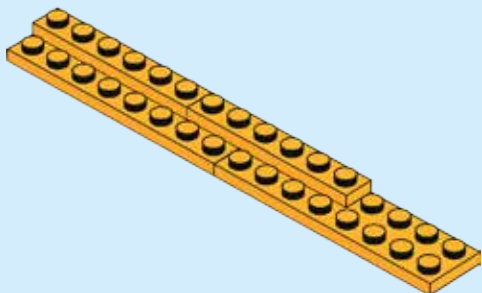

4

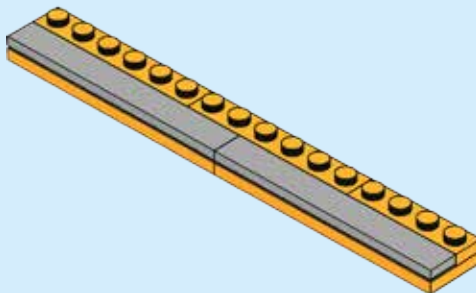

5

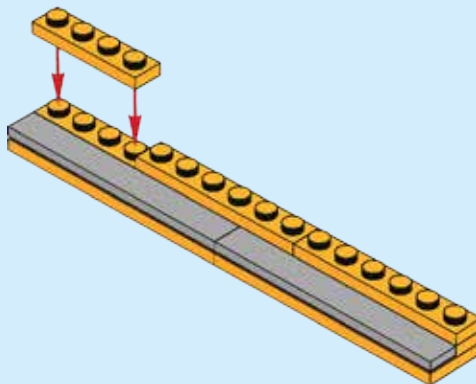

6

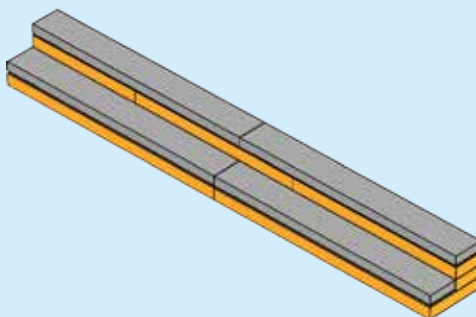



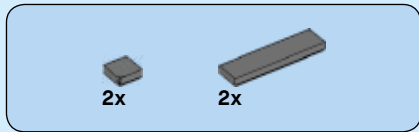

173



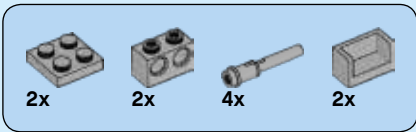

174

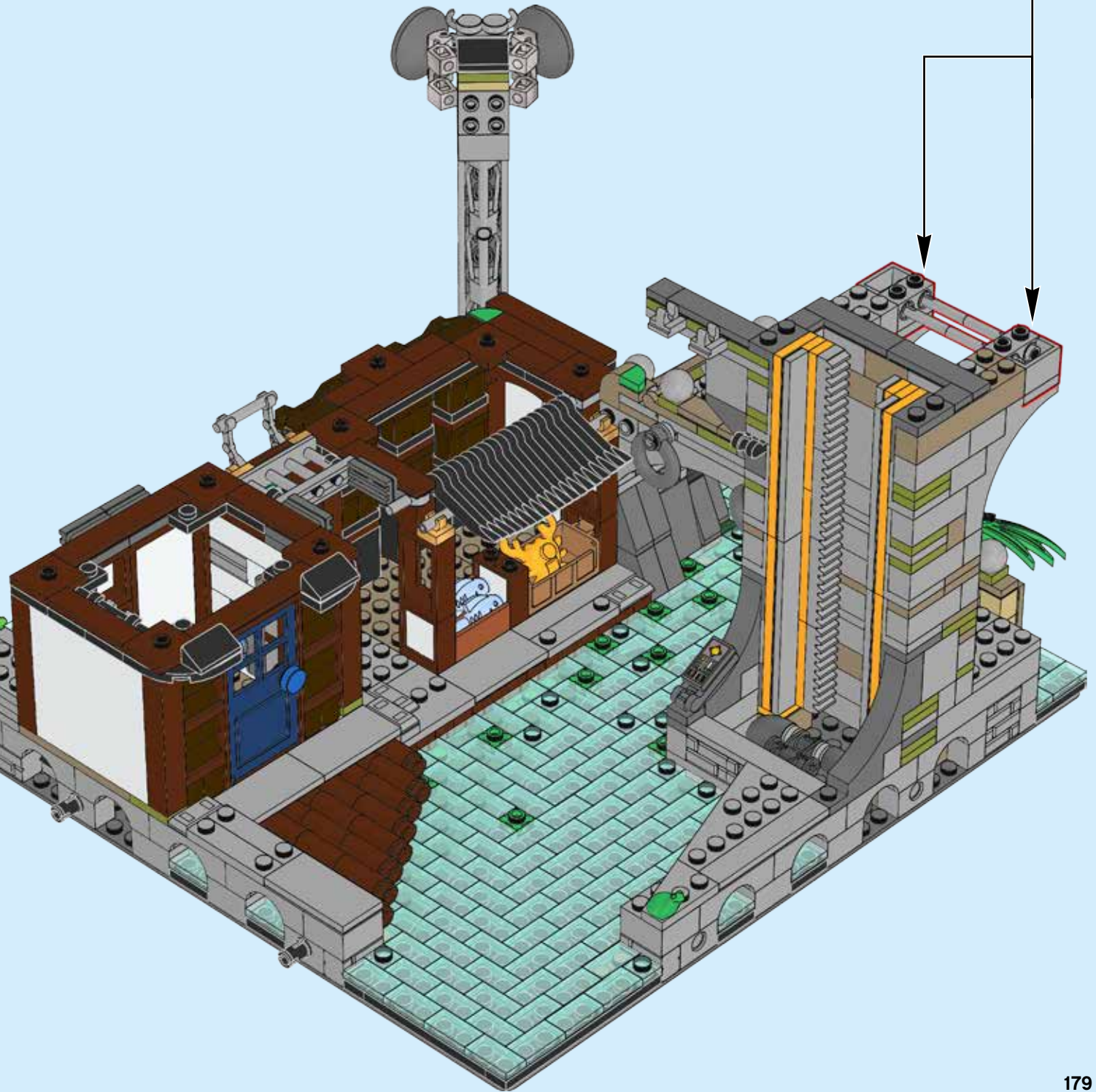
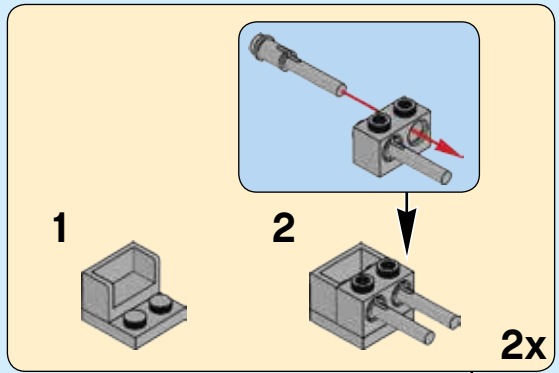

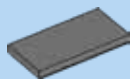

2x

175



180

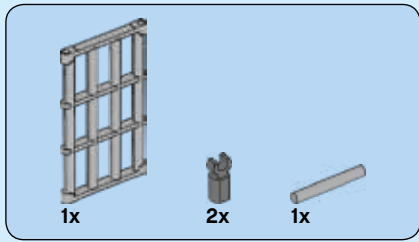

176

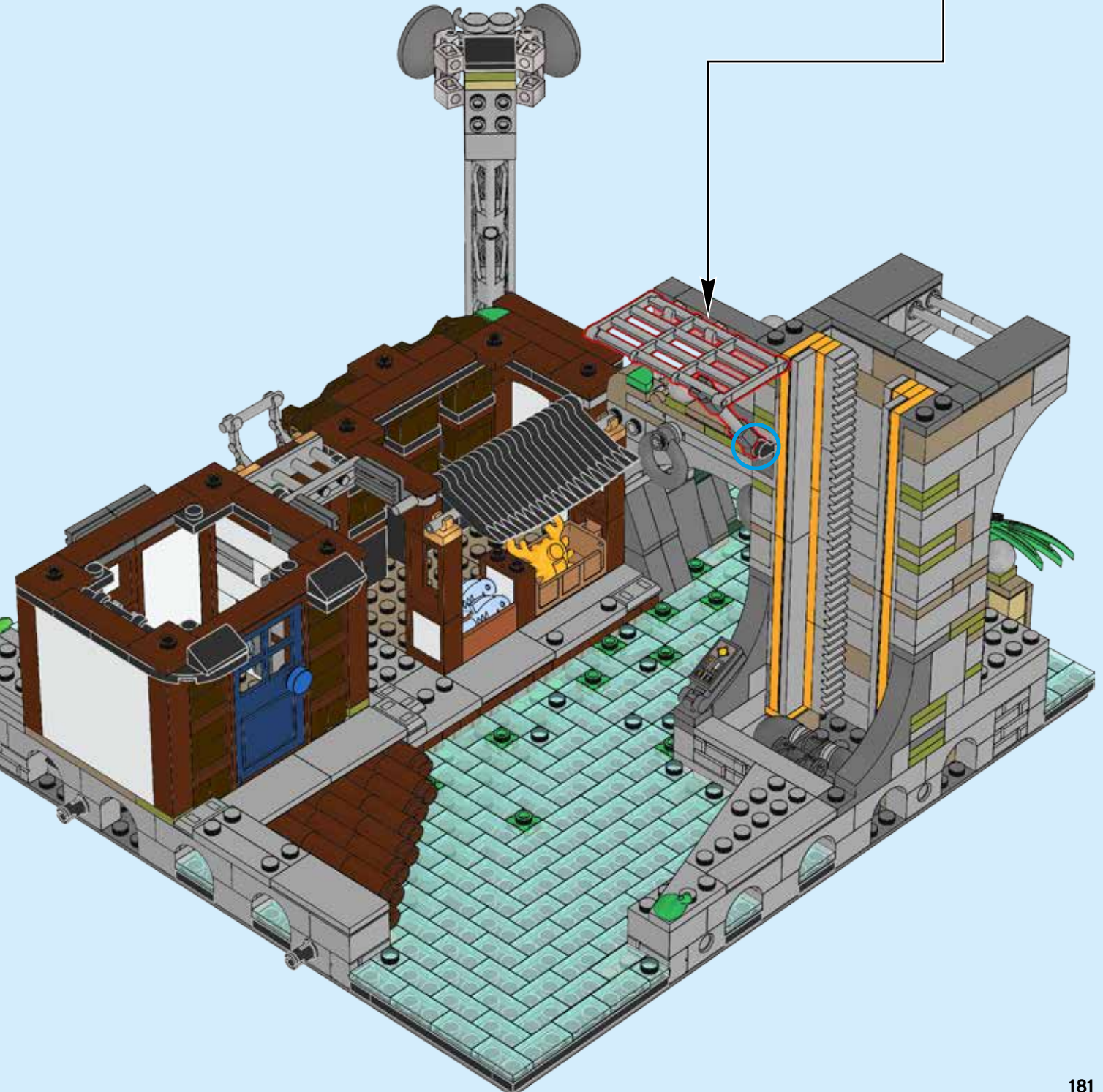
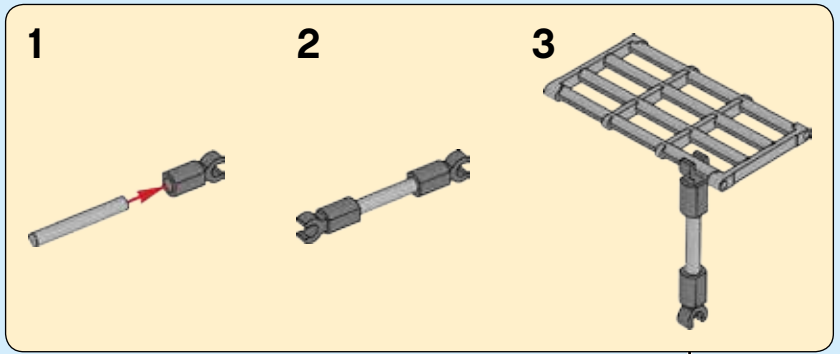

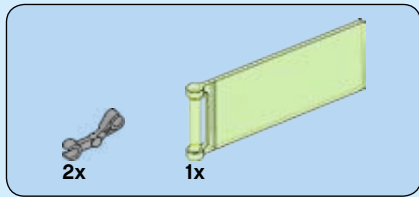

177

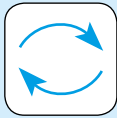
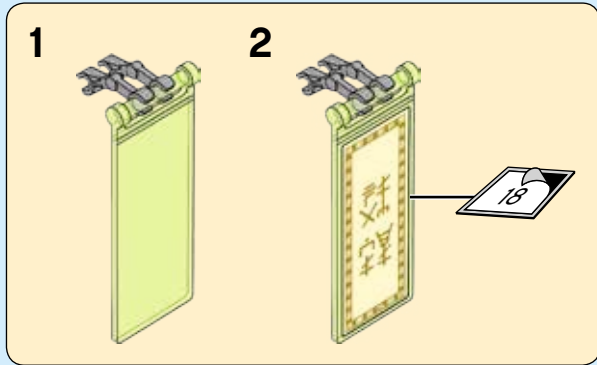

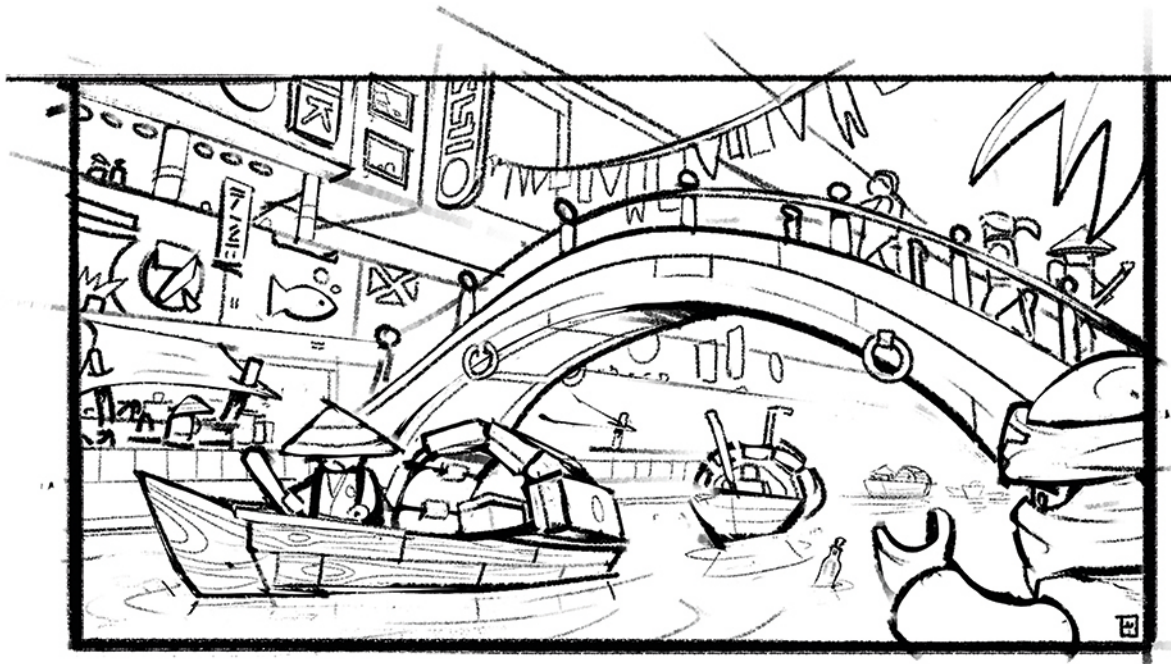
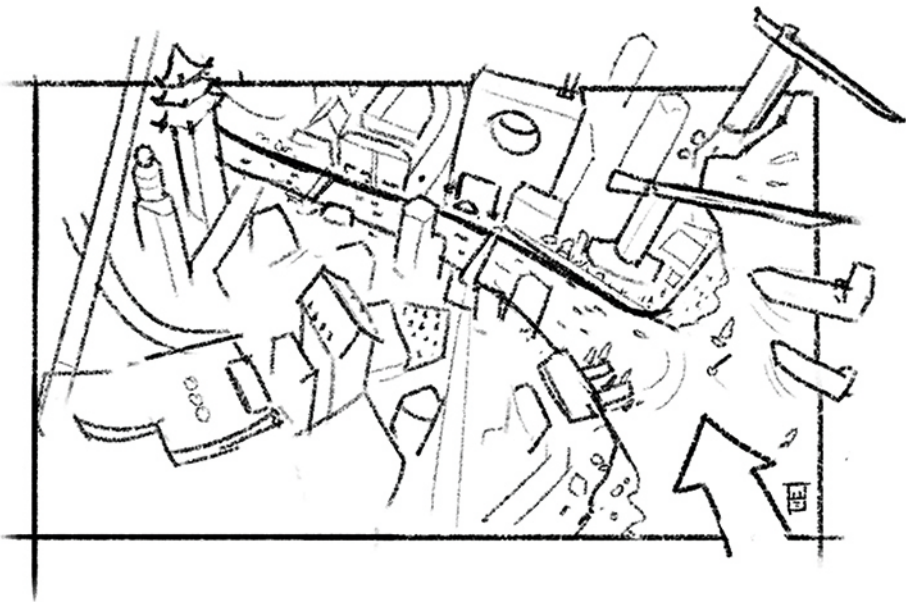

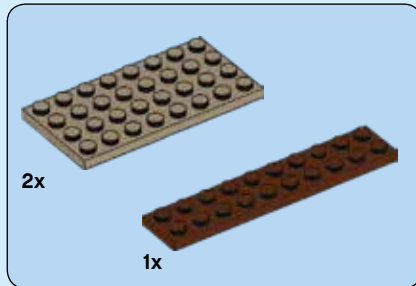

178

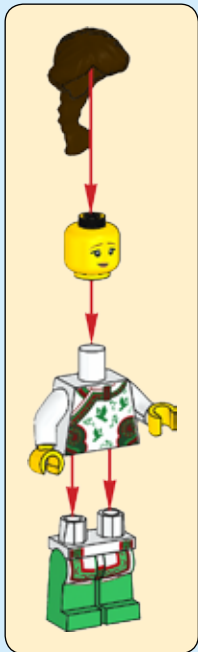

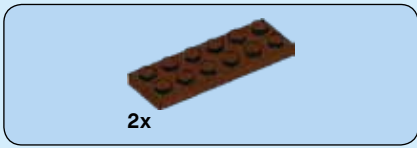

179

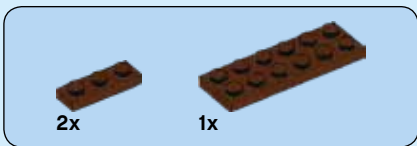
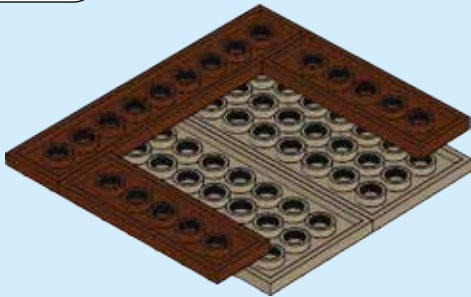

180

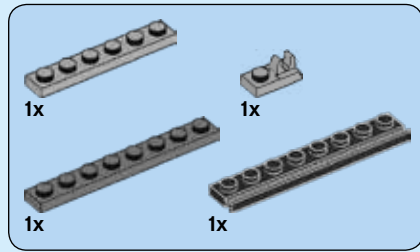

181

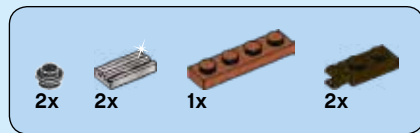
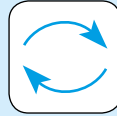

182

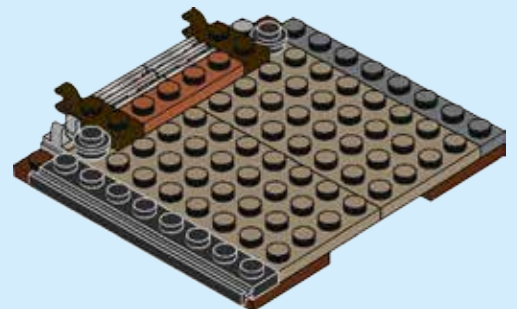

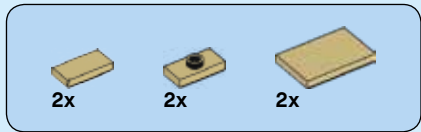

183

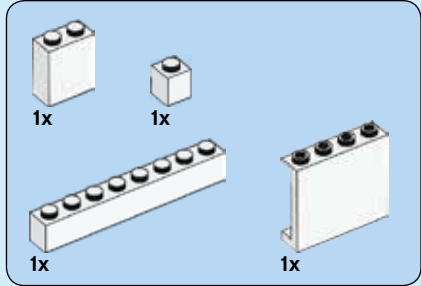
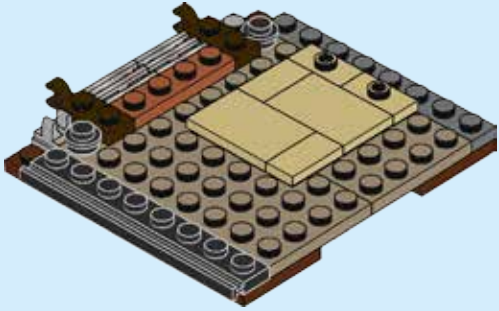

184

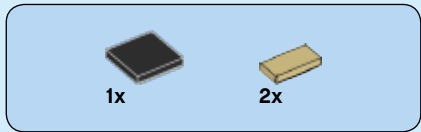
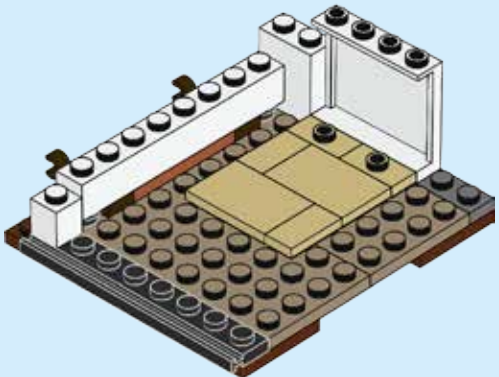

185

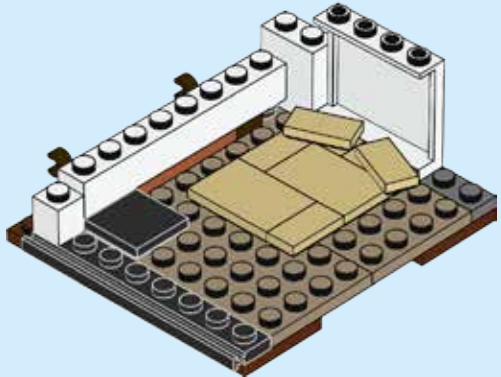

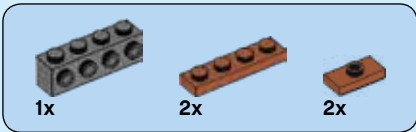

186

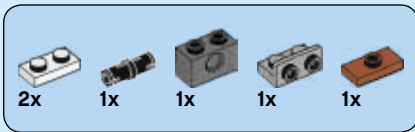
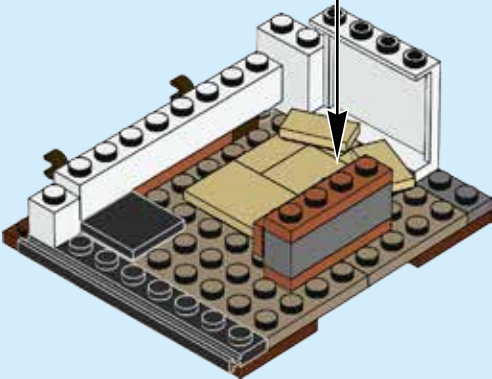
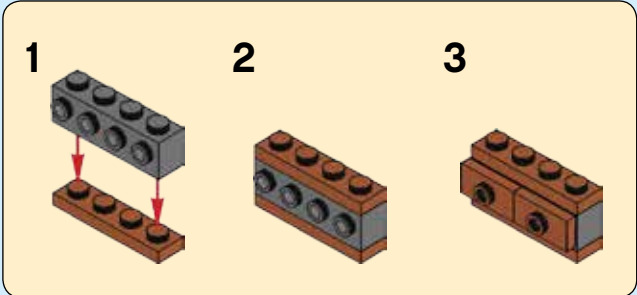

187

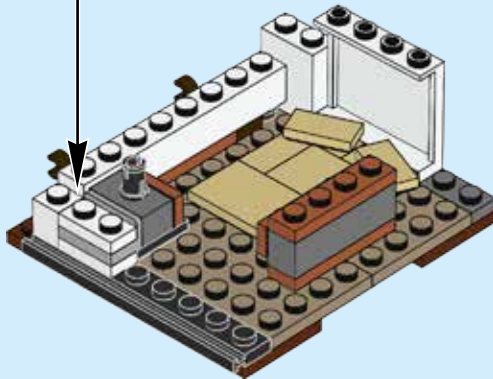
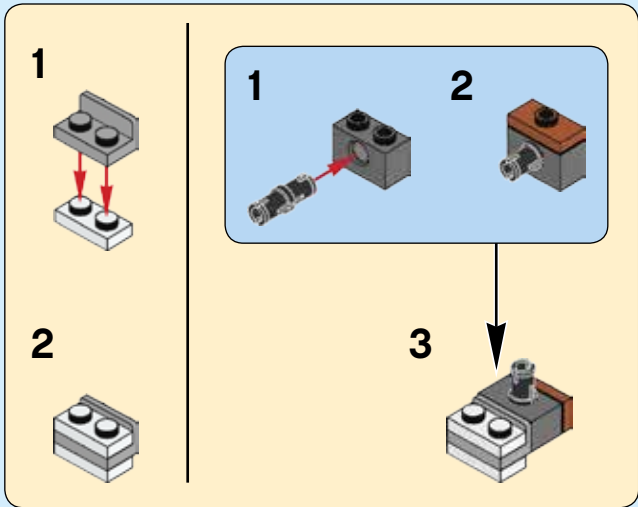

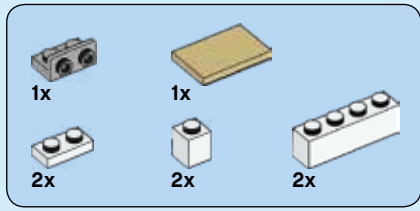

188

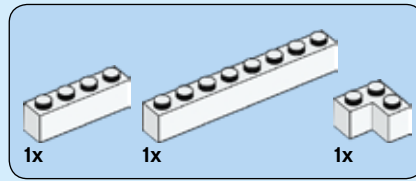
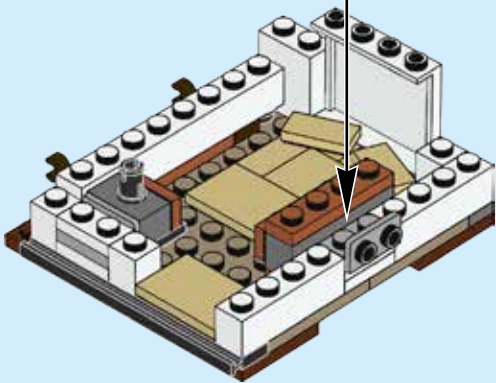
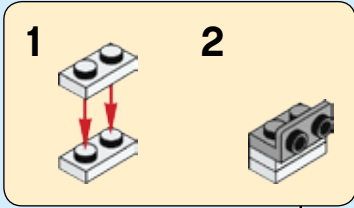

189

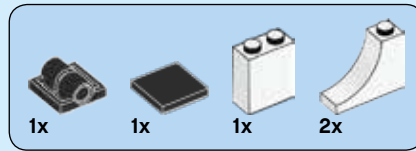
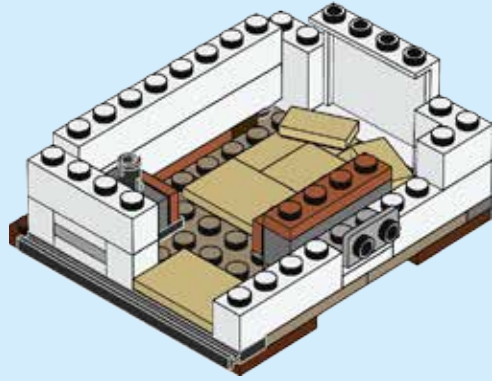

190

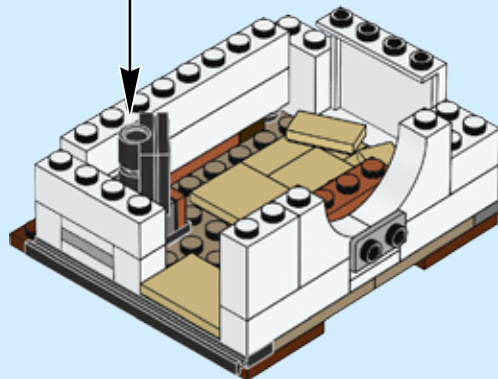
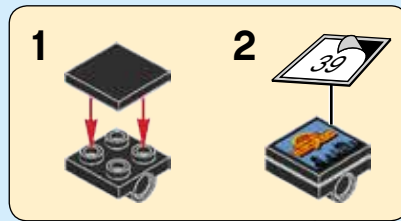

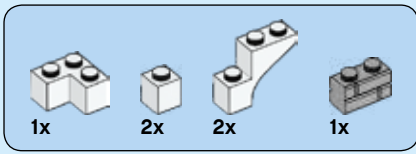

191

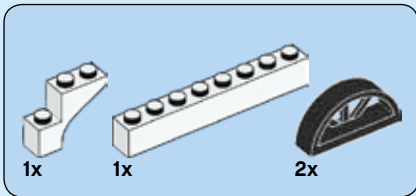
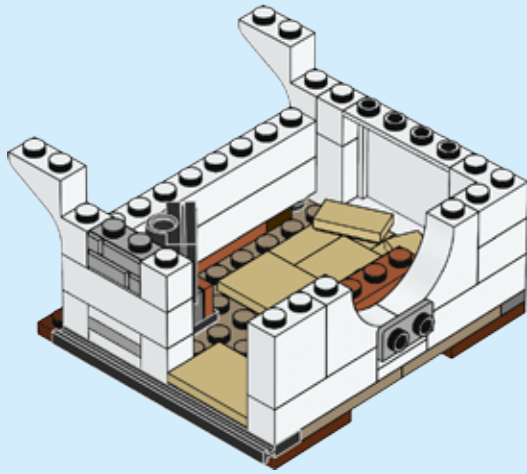

192

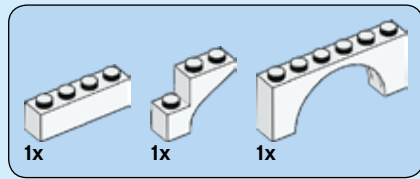
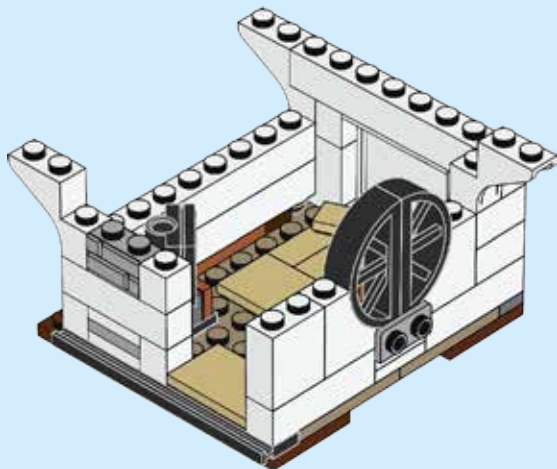

193

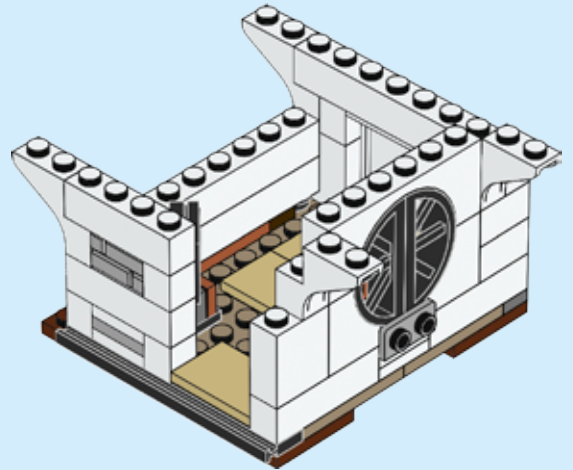



194

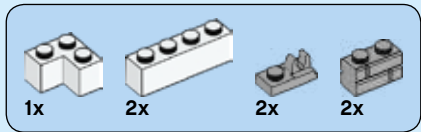
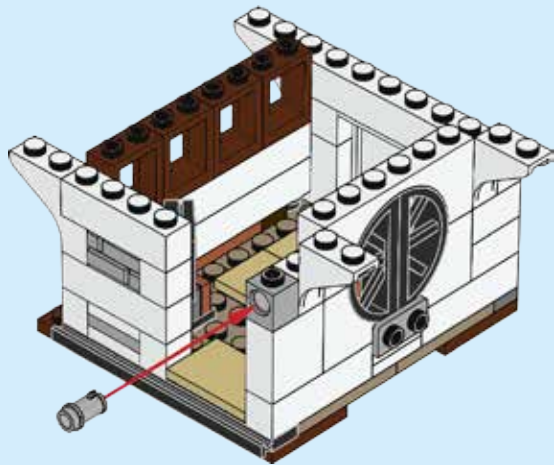

195

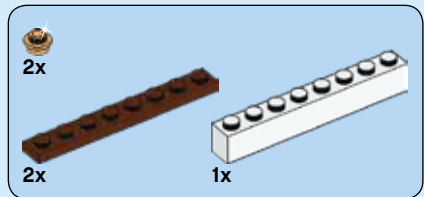
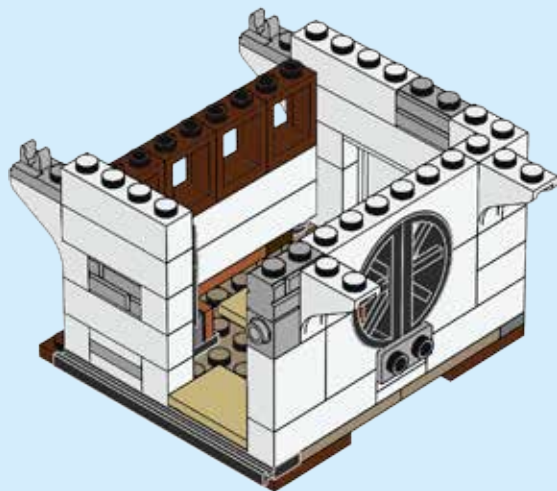

196

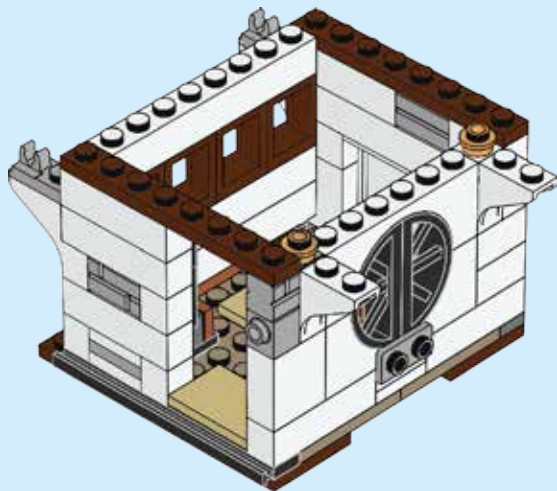

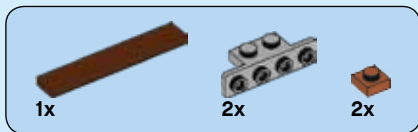

197

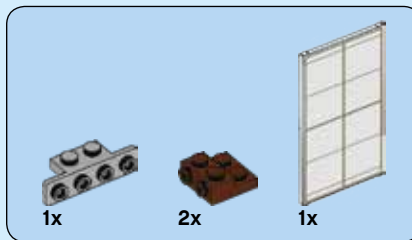
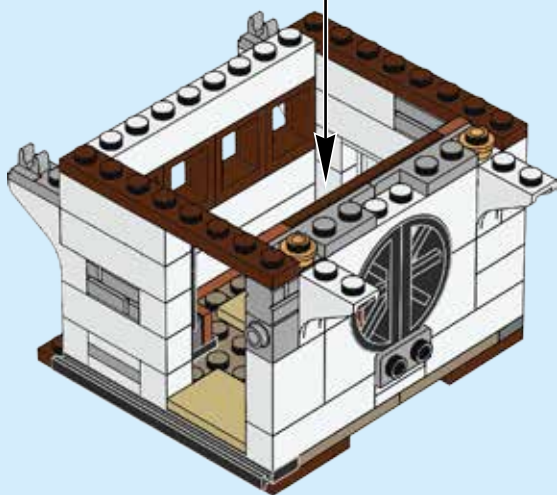
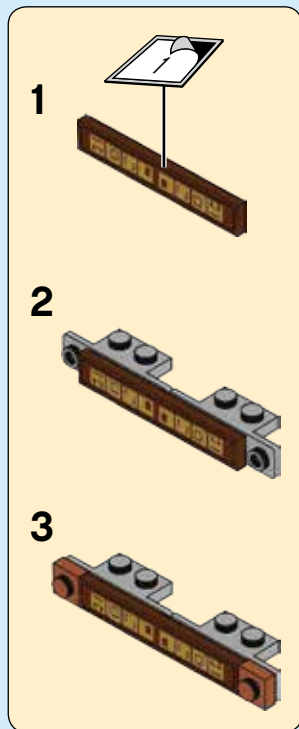

198

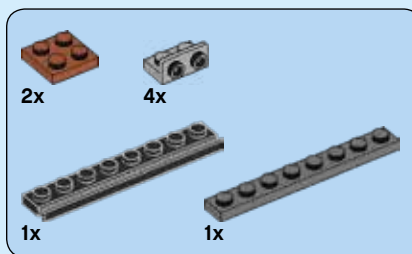
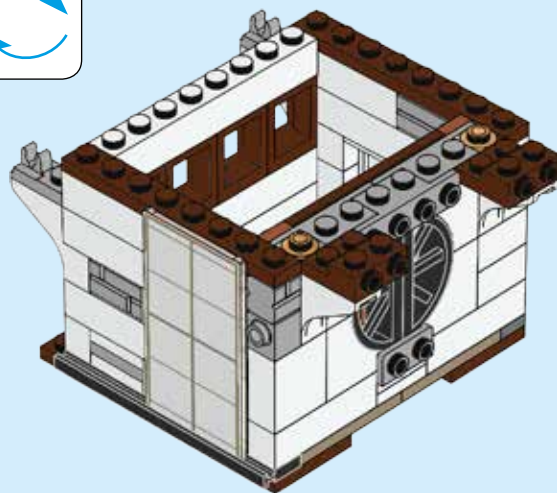
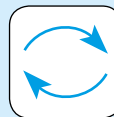

199

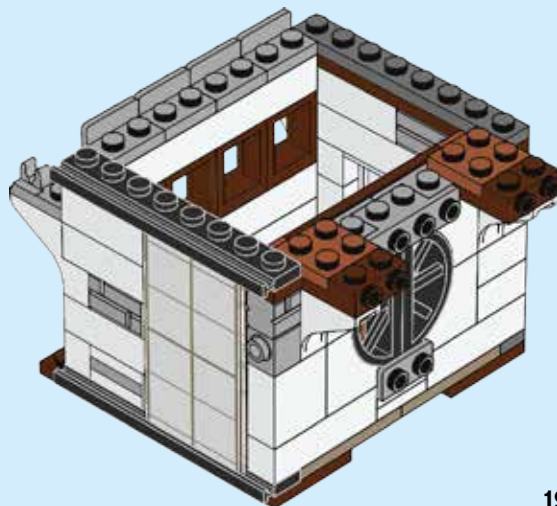

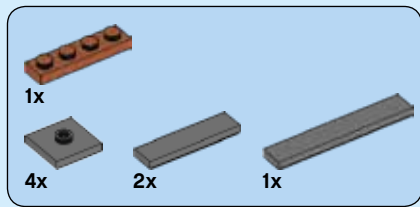

200

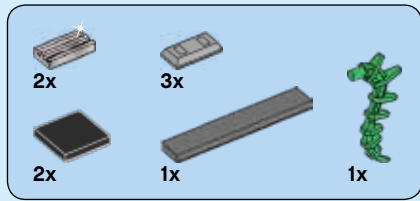
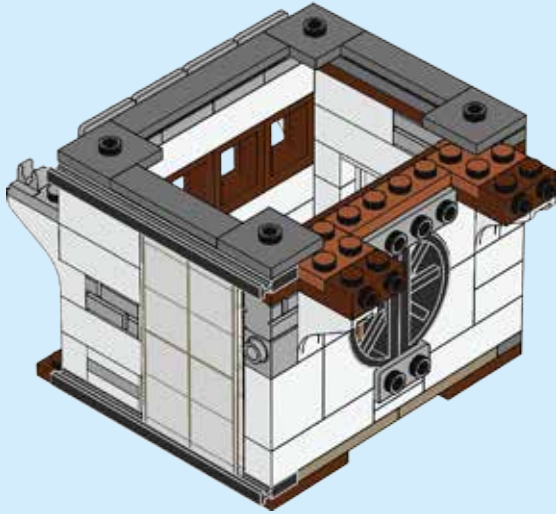

201

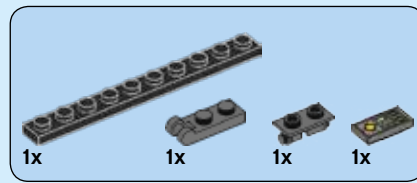
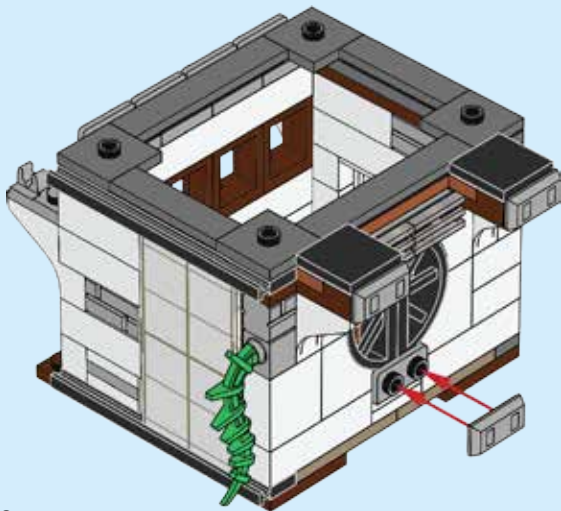

202

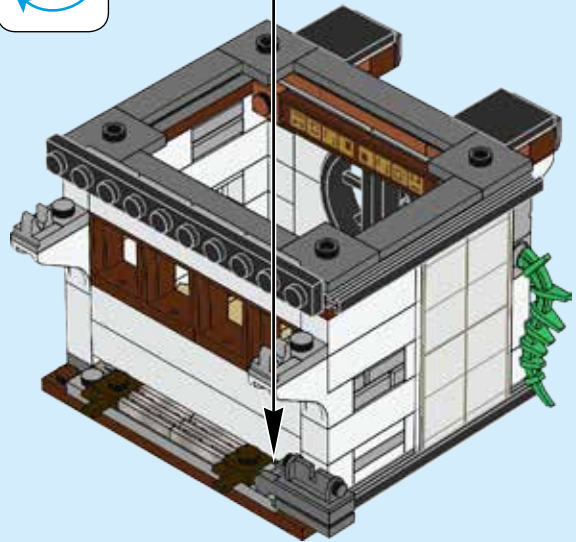
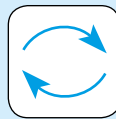
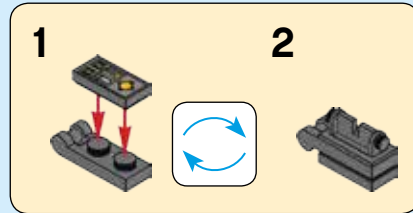

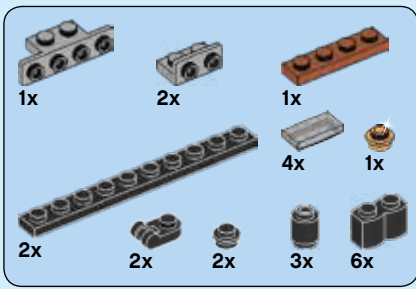

203

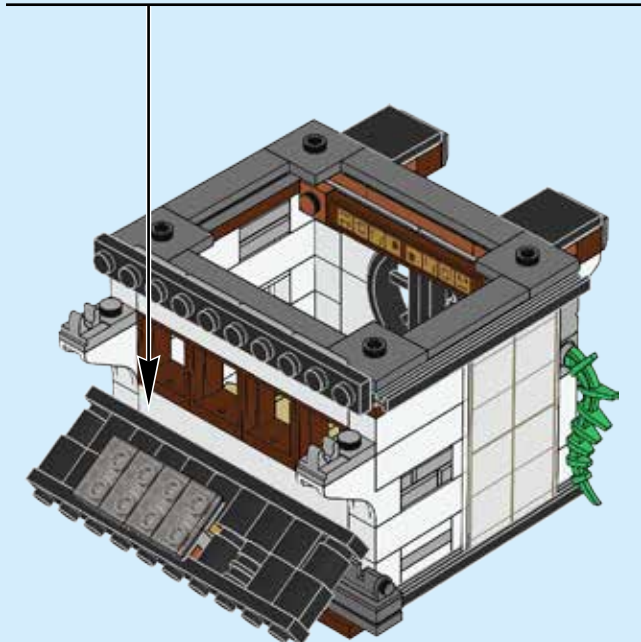
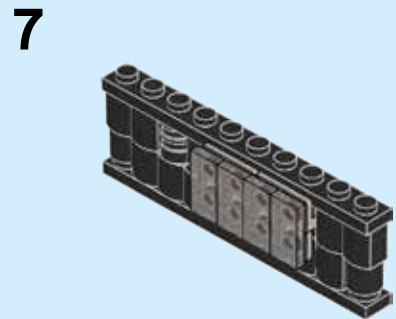
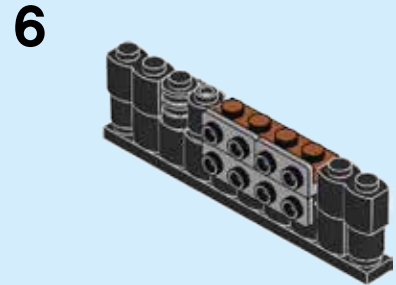
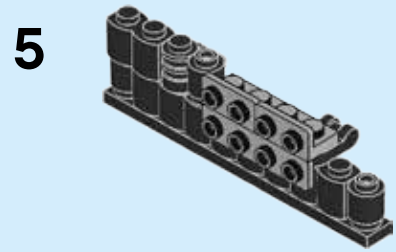
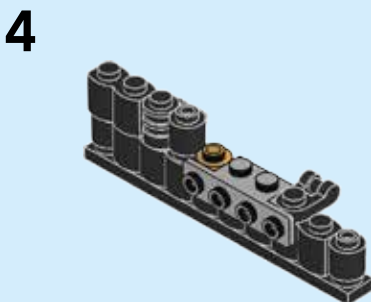
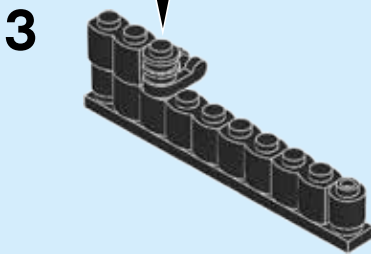
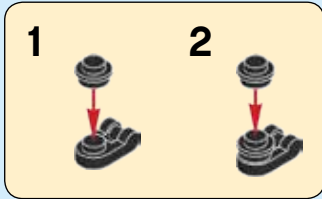
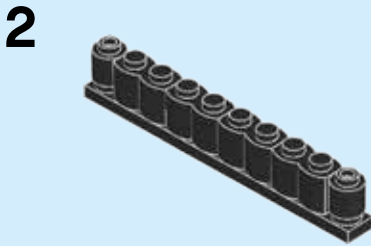
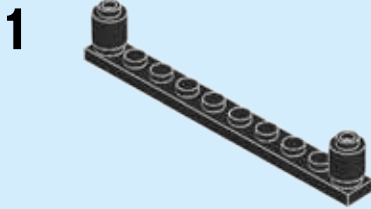

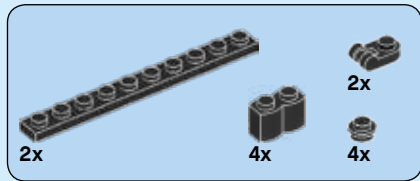

204

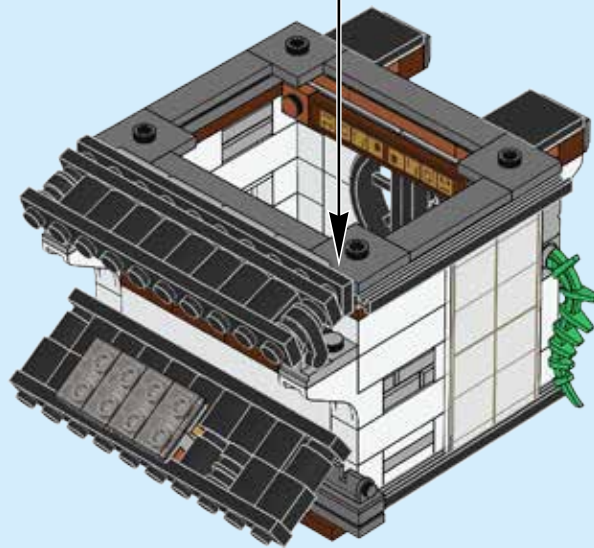
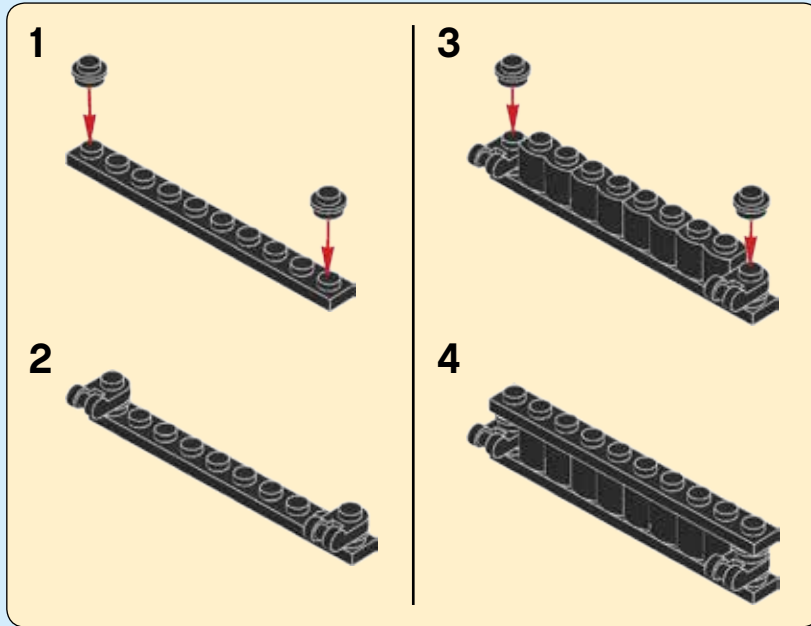

205

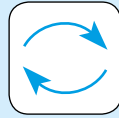

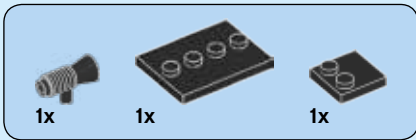

210

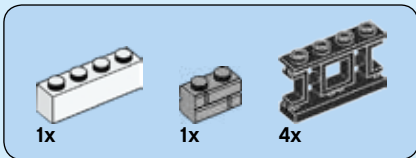
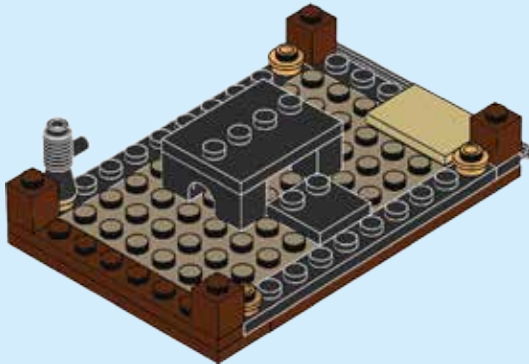

211

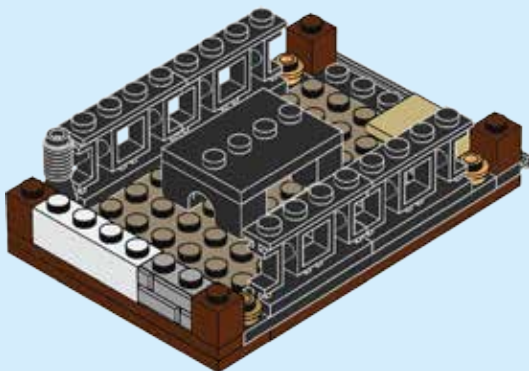

212

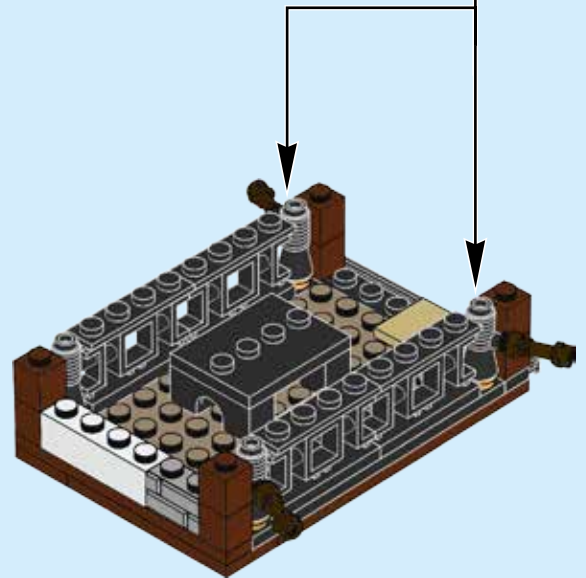
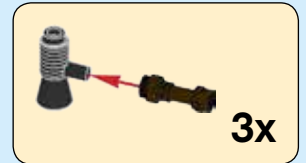



213

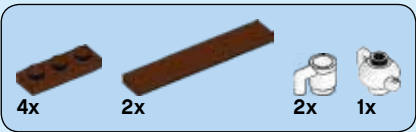
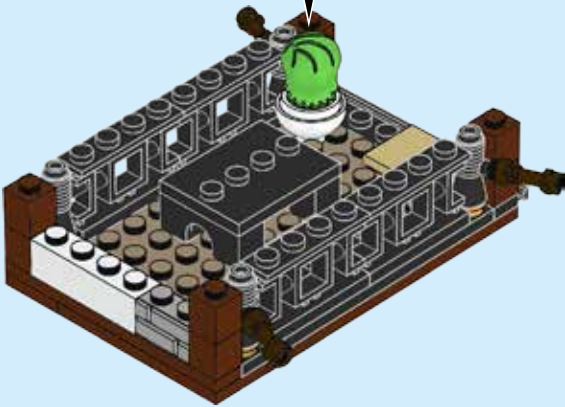

214

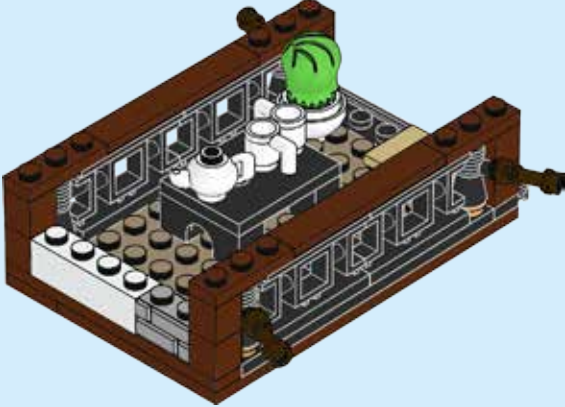

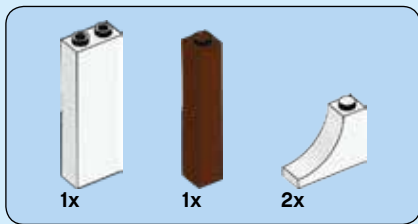

215

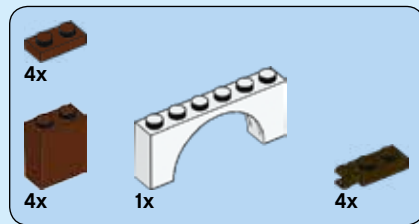
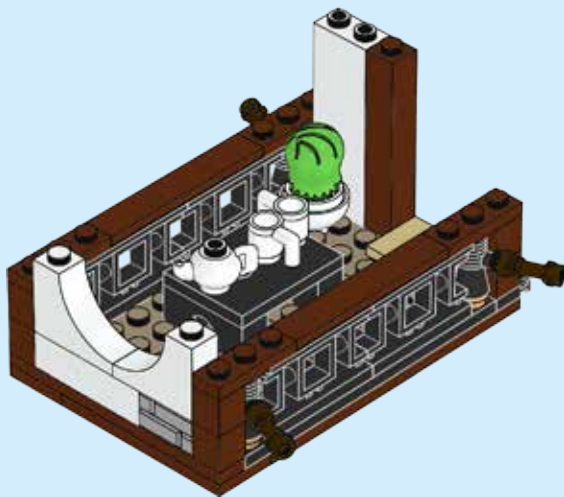

216

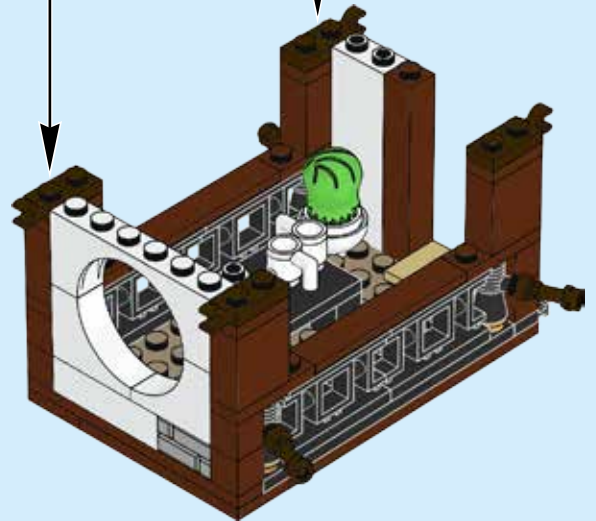
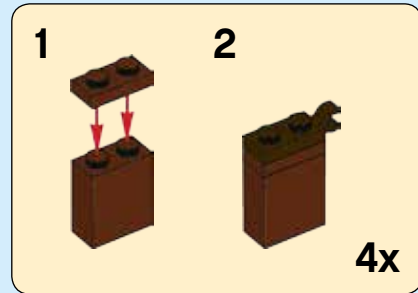

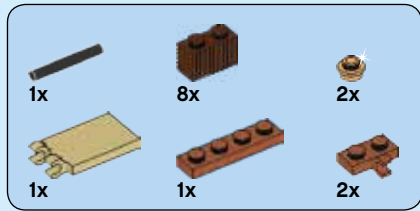

217

1

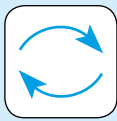
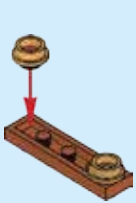

2



3



4

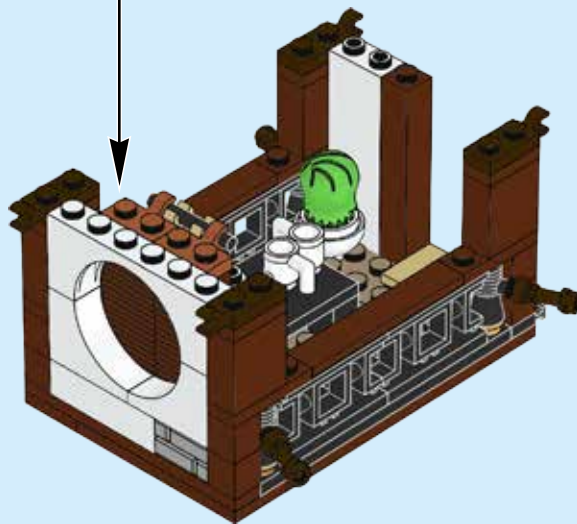
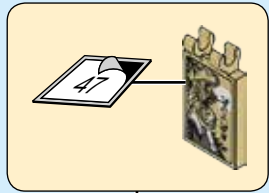

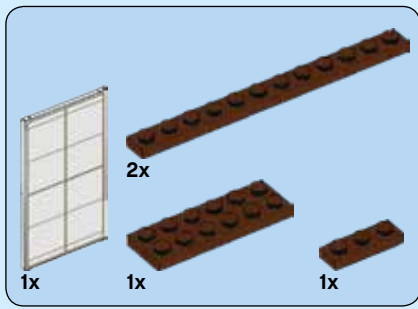

218

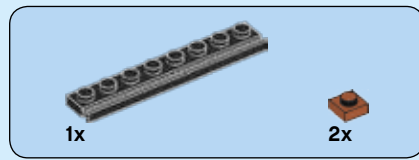
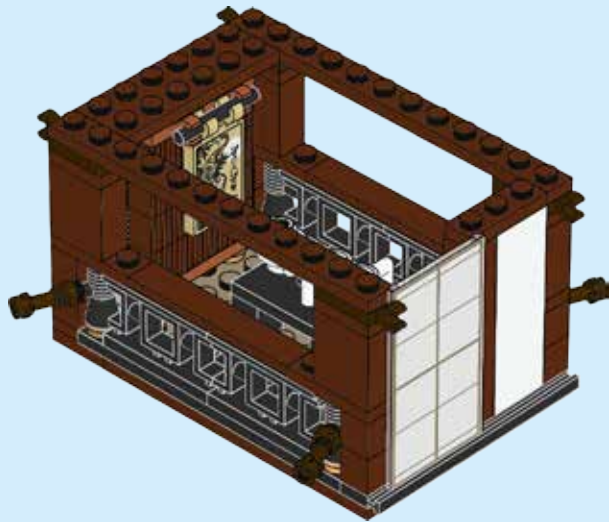
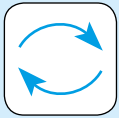

219

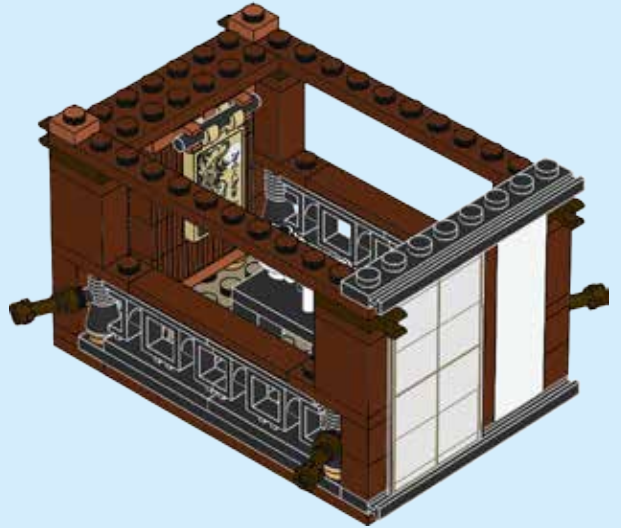

220

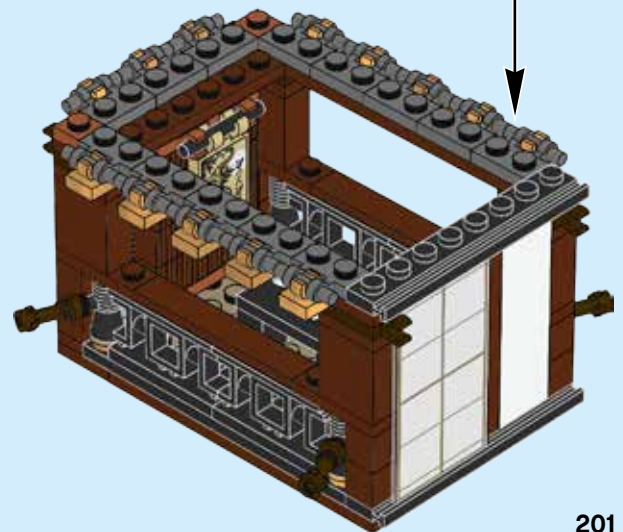
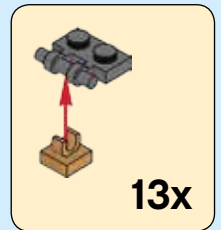

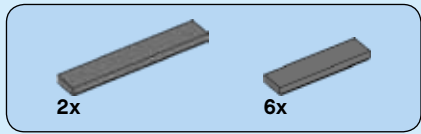

221

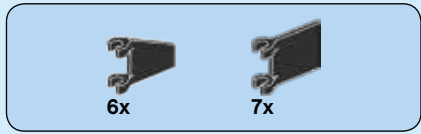
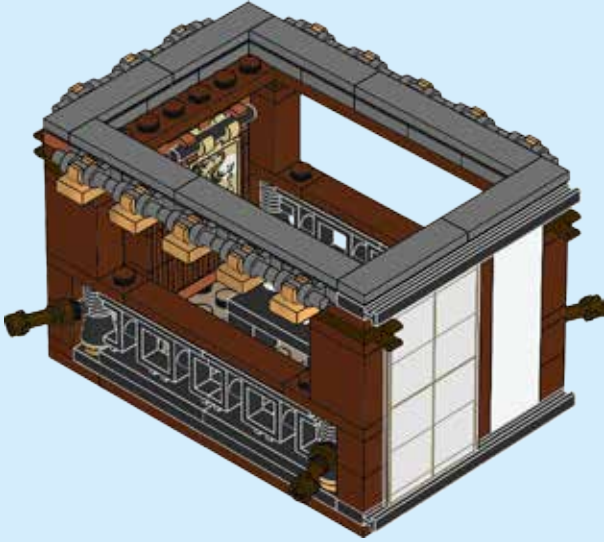

222

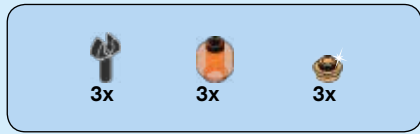
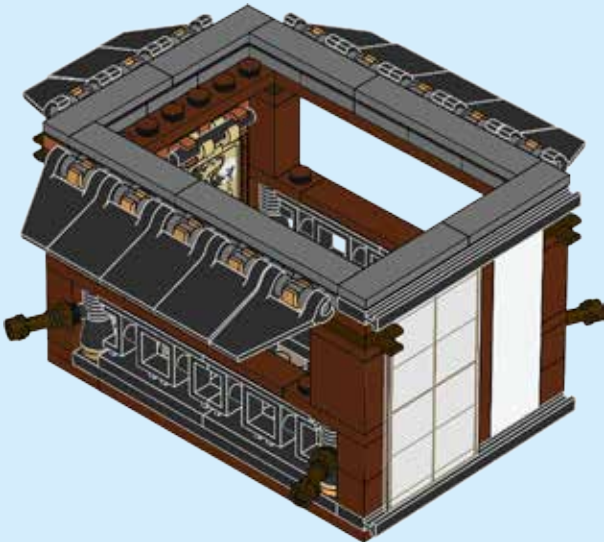

223

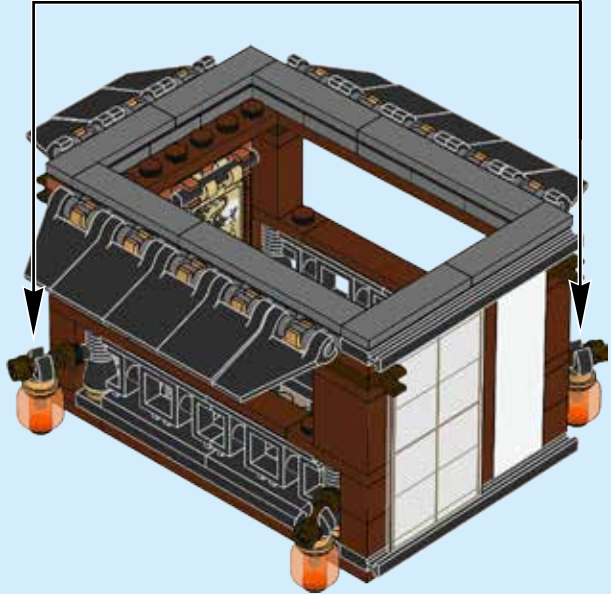

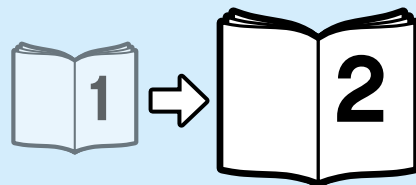

WIN

GO TO WWW.LEGO.COM/PRODUCTFEEDBACK
AND GIVE US YOUR SHORT **FEEDBACK**
ABOUT THIS LEGO® SET FOR A CHANCE
TO WIN A COOL LEGO PRIZE.

Terms & Conditions apply



LEGO.com/productfeedback

GEWINNE

Erzähle uns auf
www.LEGO.com/productfeedback

etwas über die Erfahrungen, die du mit
diesem LEGO® Set gemacht hast, und
sichere dir die Chance auf einen coolen
LEGO Preis!

Es gelten die Teilnahmebedingungen

GAGNE

Rends-toi sur
www.LEGO.com/productfeedback

et donne-nous quelques commentaires
sur ce produit LEGO® pour avoir une
chance de gagner un prix LEGO !

Voir Conditions Générales

GANAN

Visita
www.LEGO.com/productfeedback

y envíanos tu opinión acerca de este
set LEGO®. ¡Participarás en el sorteo
de un premio LEGO!

Términos y Condiciones aplicables

获取奖品

登录
www.LEGO.com/productfeedback

给出关于此乐高®套装的简短反馈，
就有机会获得炫酷乐高奖品

《条款及条件》适用

경품 당첨 기회

www.LEGO.com/productfeedback

페이지로 이동하여 이 레고® 세트에 대한
간략한 피드백을 보내 주시고 멋진 레고
경품을 탈 수 있는 기회도 잡으십시오

약관 적용

ЗАПОЛНИ АНКЕТУ И ПОЛУЧИ ПРИЗ

Перейди по ссылке
www.LEGO.com/productfeedback

ответь всего на несколько вопросов
об этом наборе LEGO®, и у тебя появ-
ится шанс выиграть замечательный
приз от компании LEGO.

Применяются Условия и правила
участия