



MINECRAFT



21118





LEGO.com/brickseparator

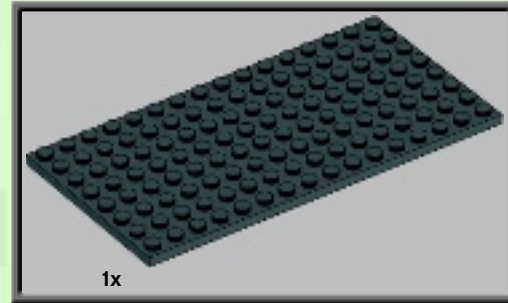
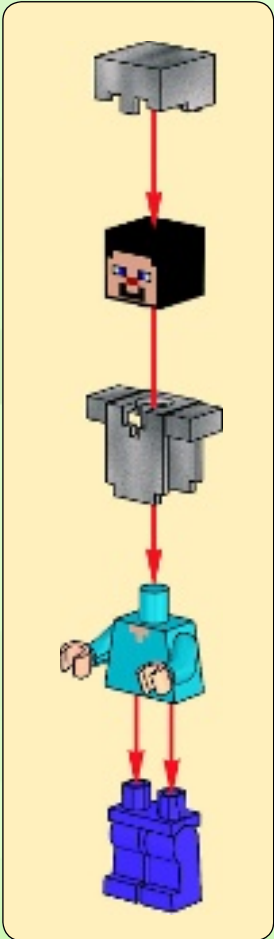
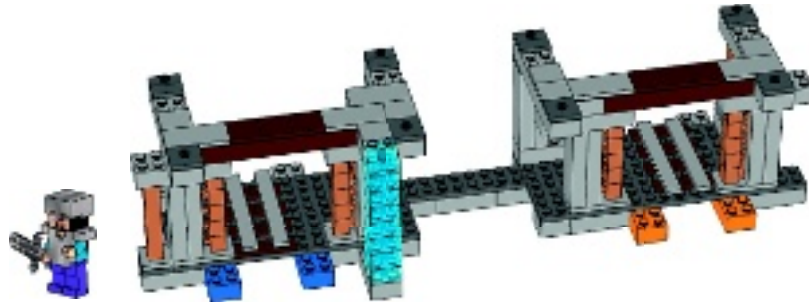

1





2

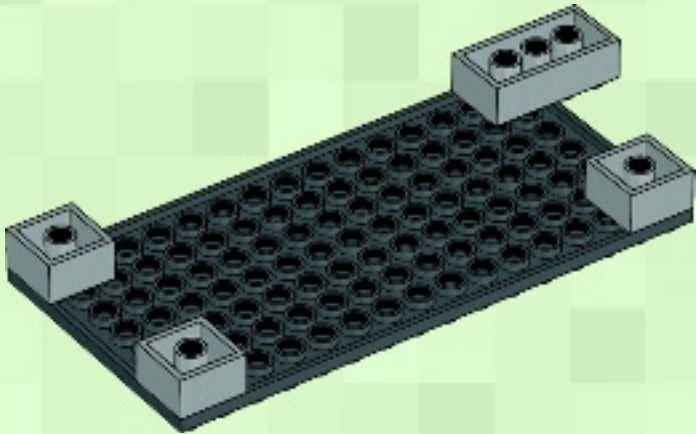

3

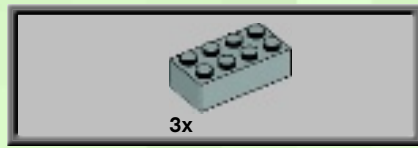
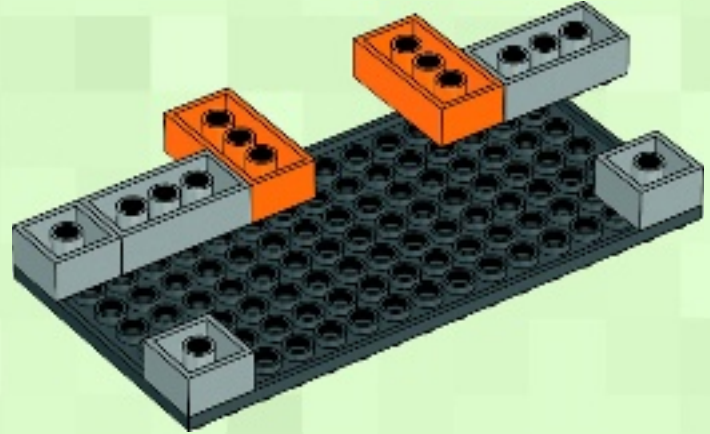

4

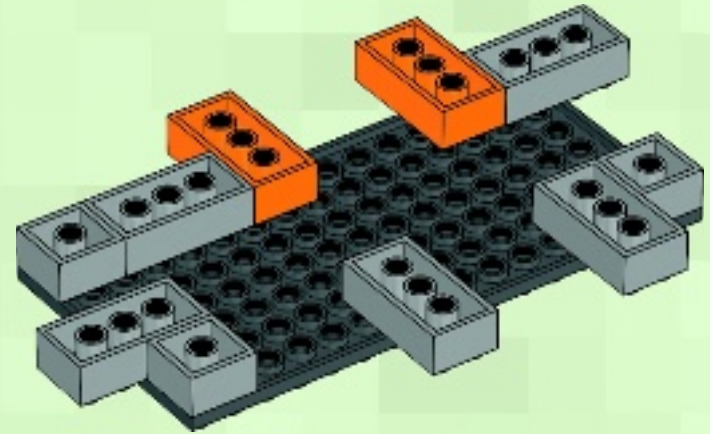

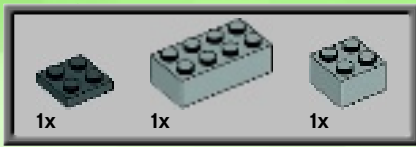

5

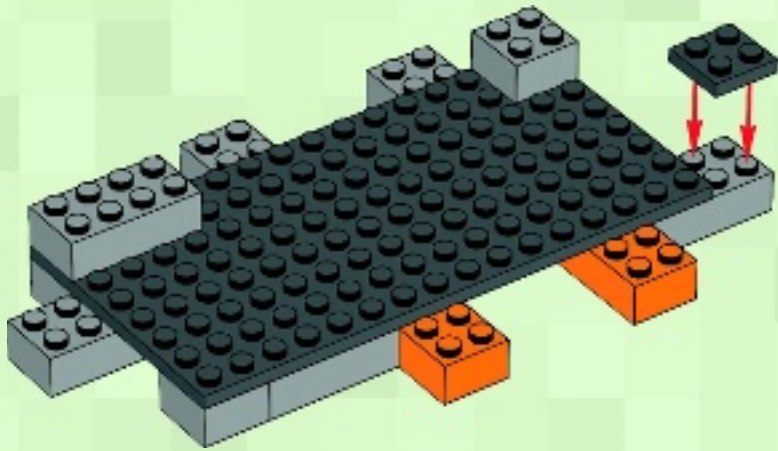
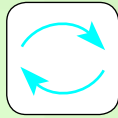

6

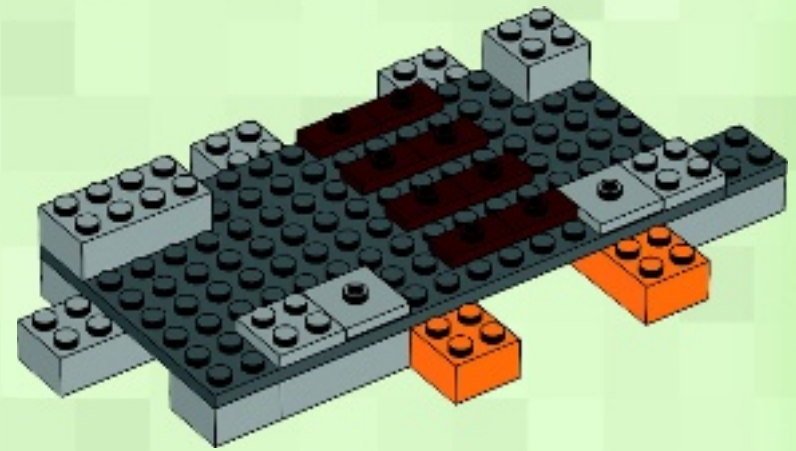

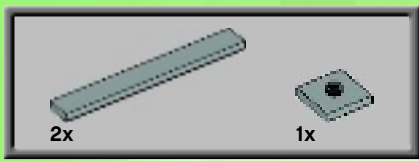

7

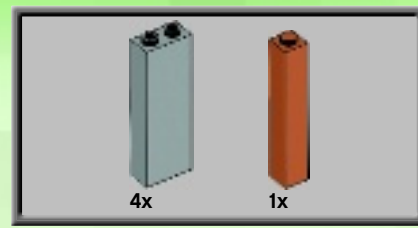
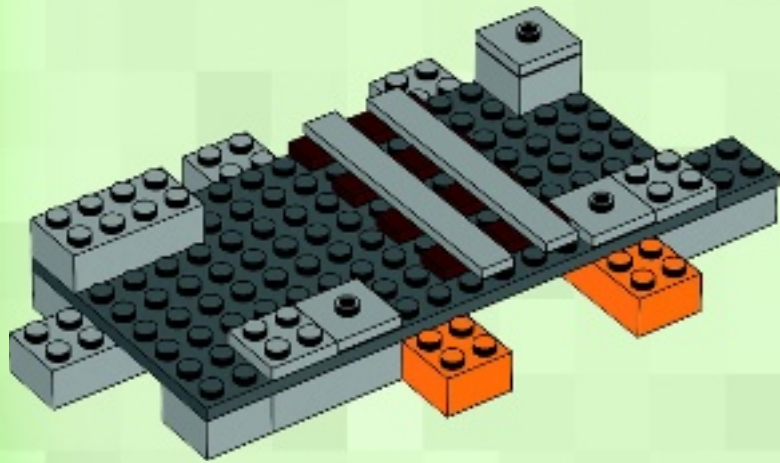

8

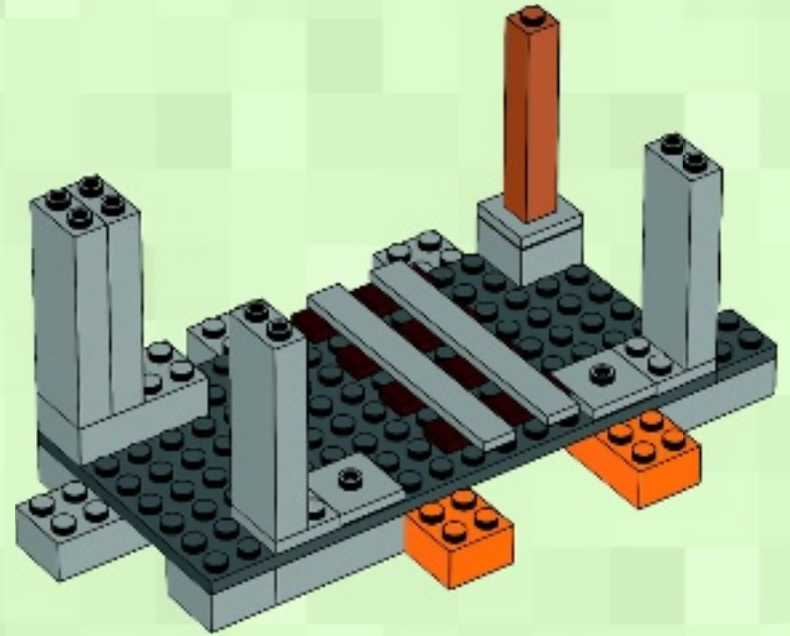

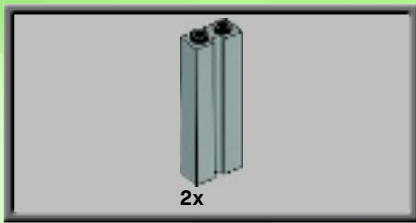

9

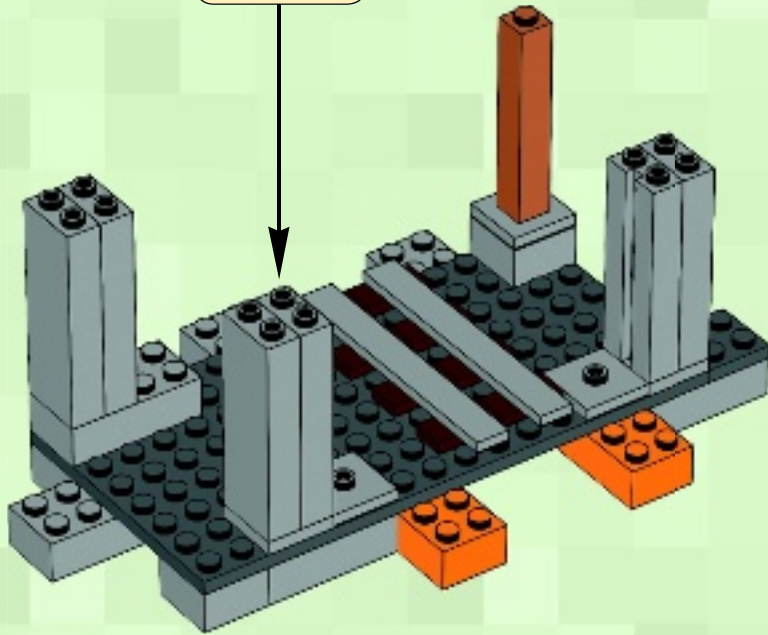
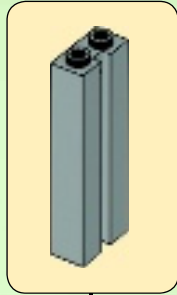

10

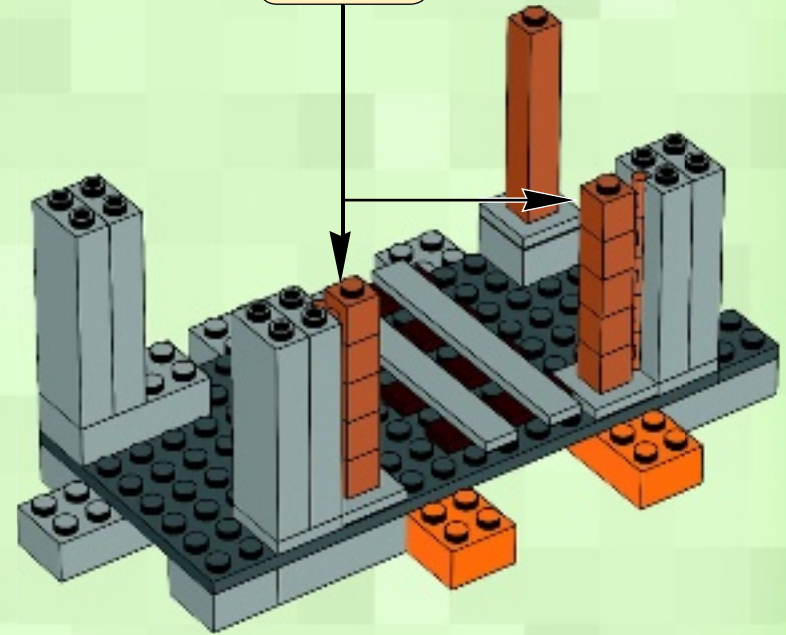
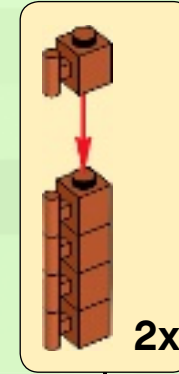

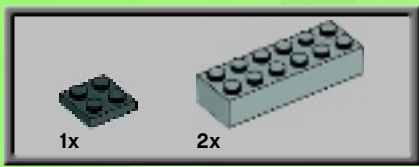

11

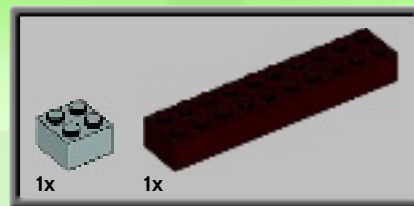
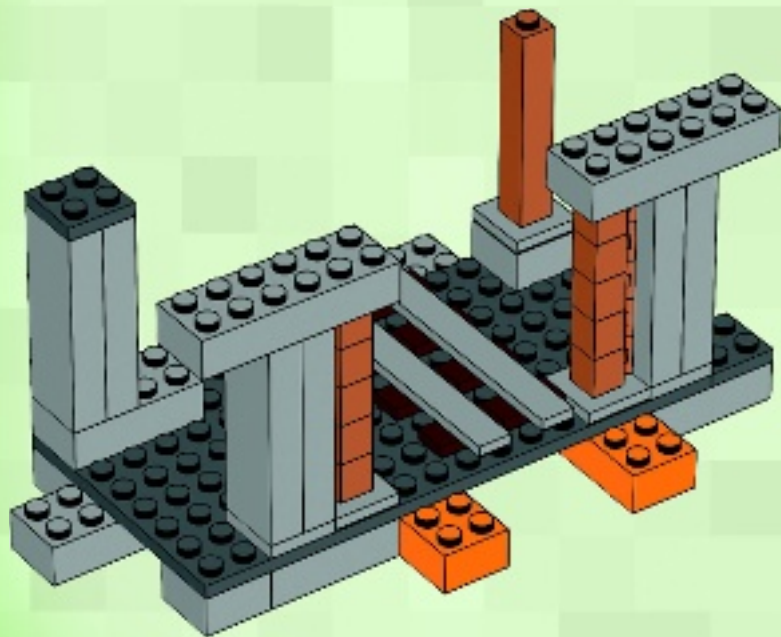

12

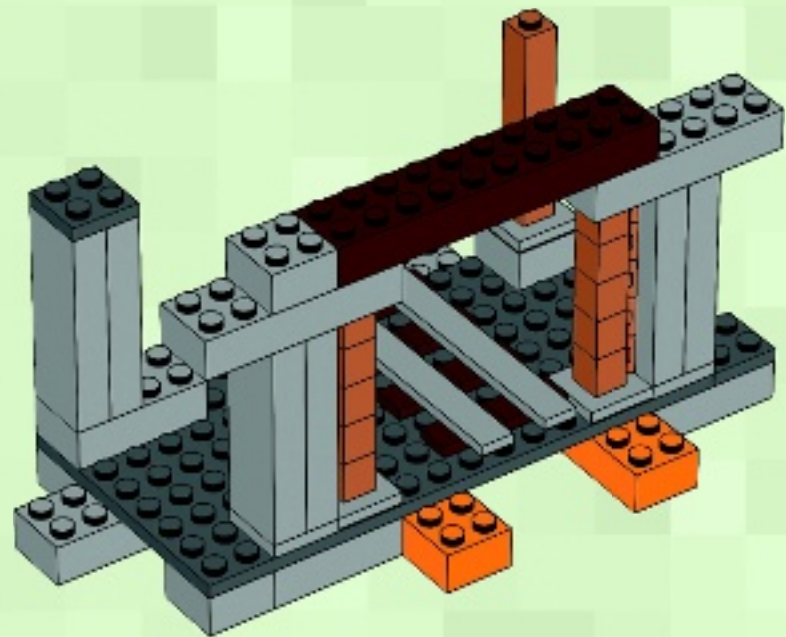

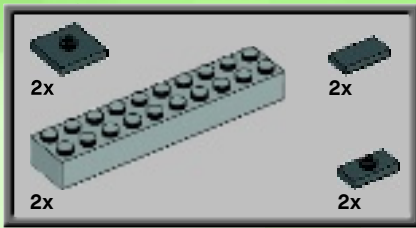

13

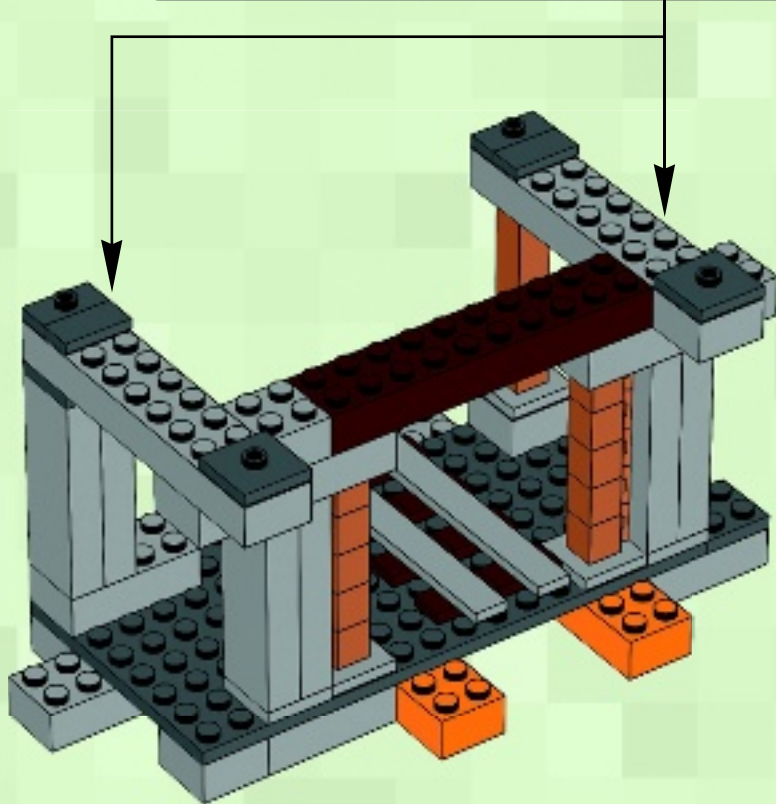
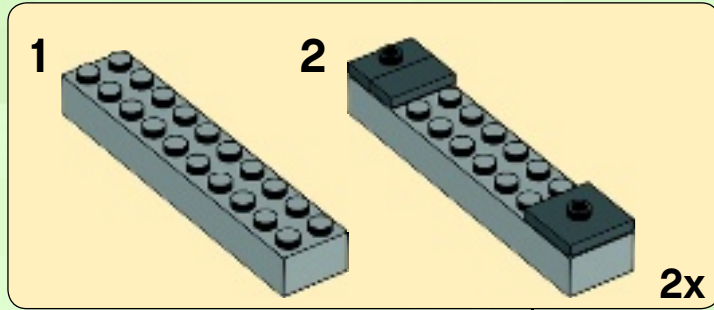

14

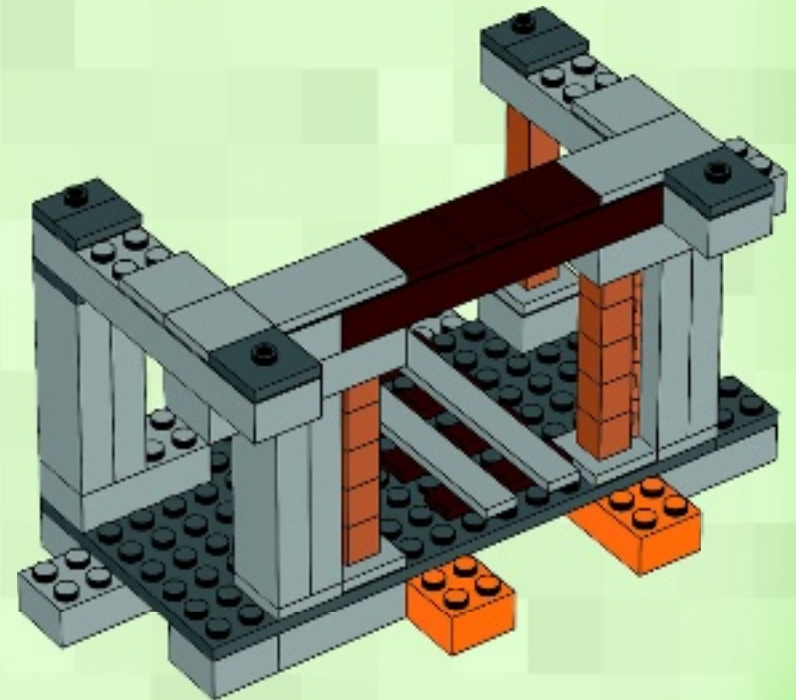

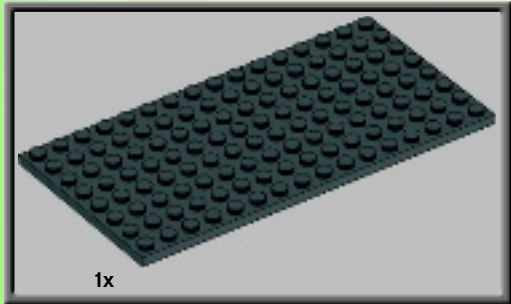
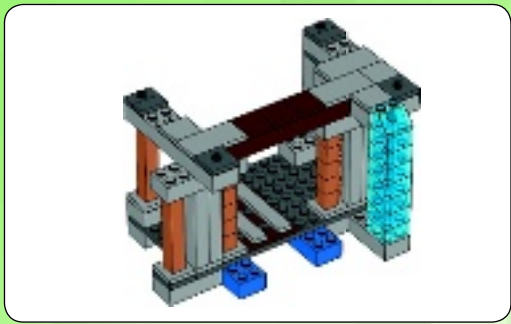

1

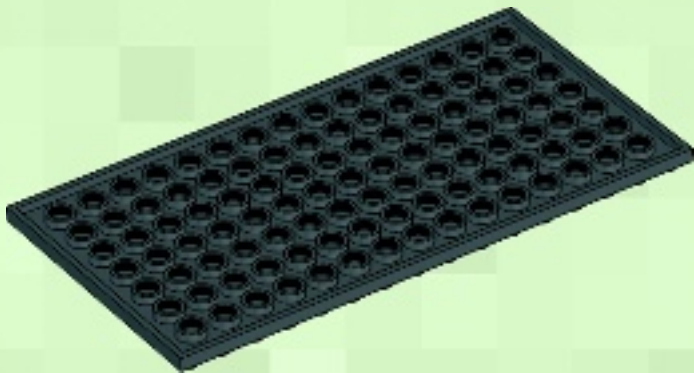

2

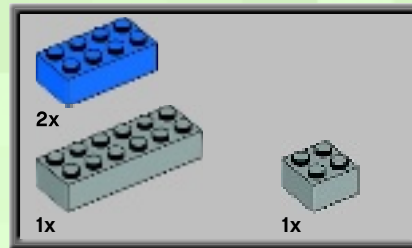
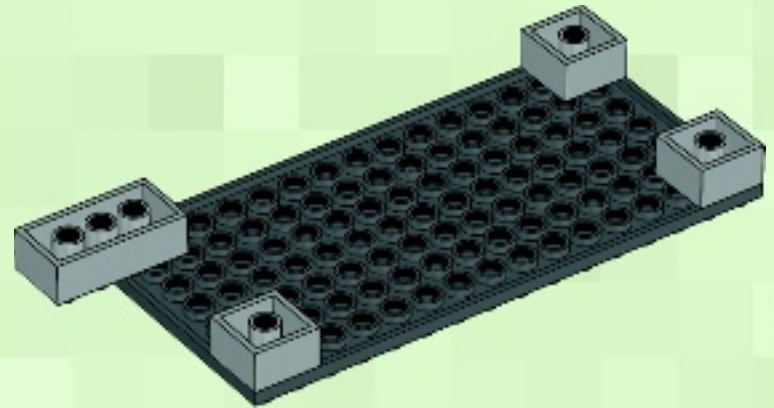

3

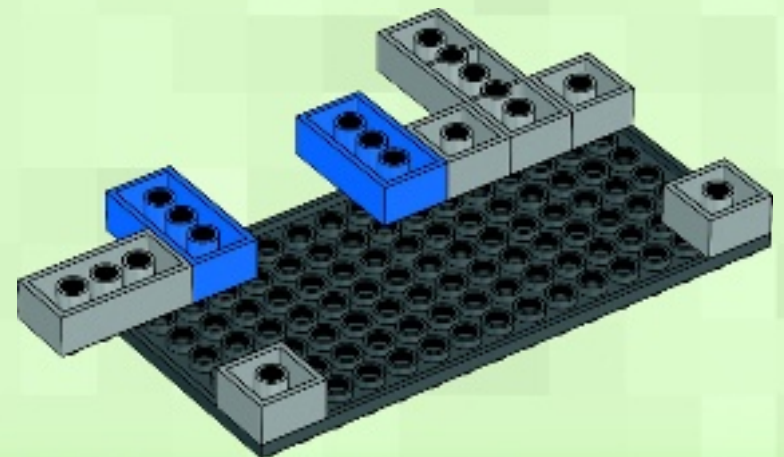

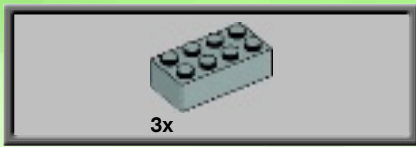

4

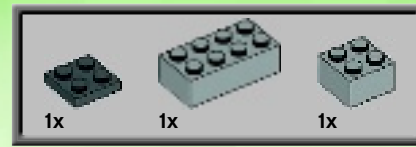
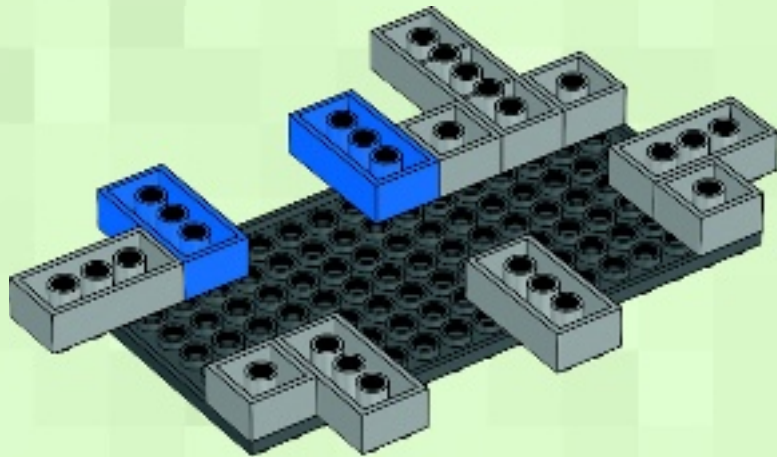

5

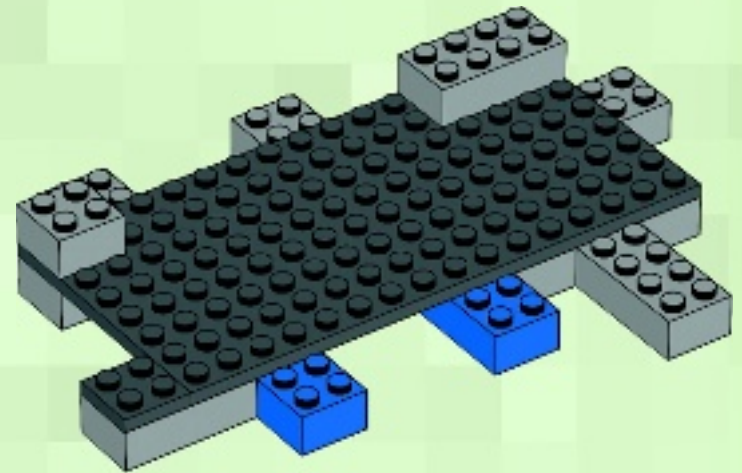
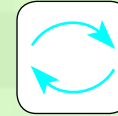



6

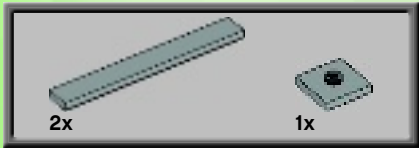
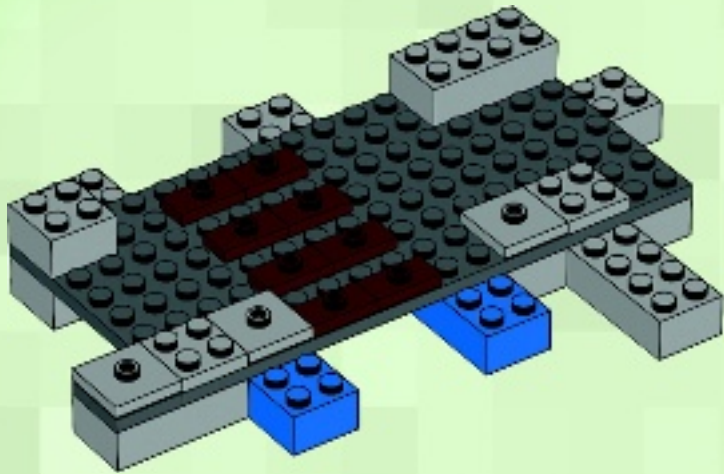

7

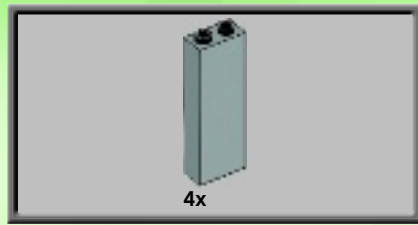
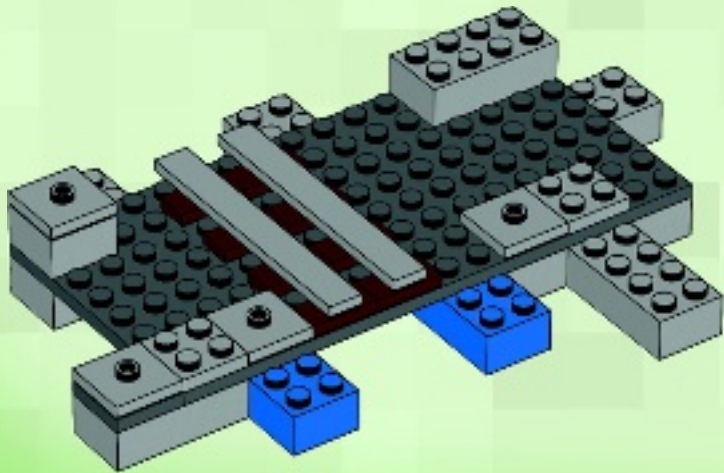

8

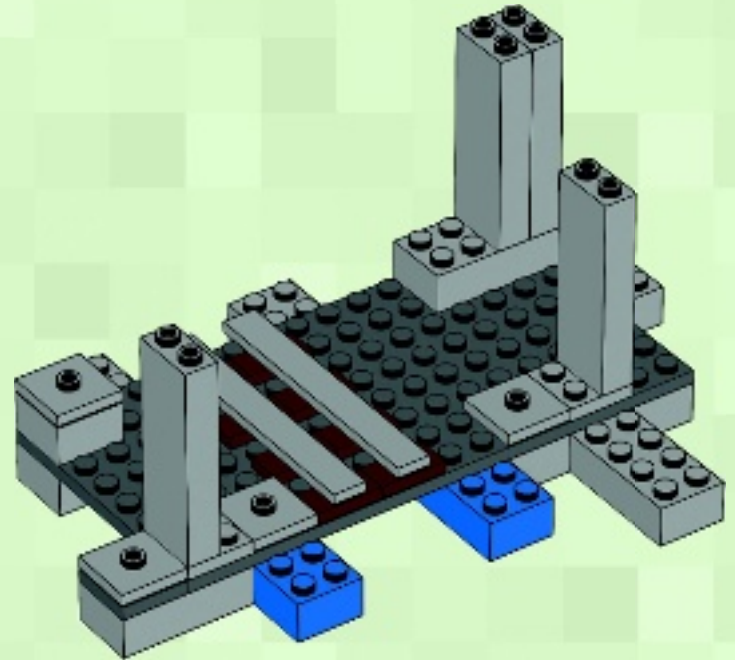

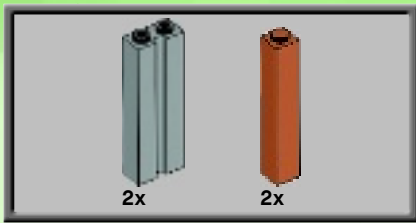

9

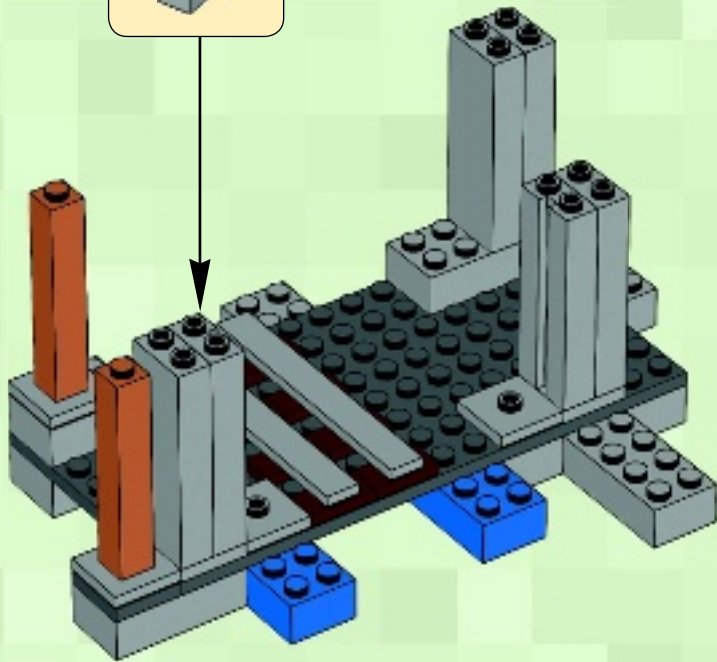
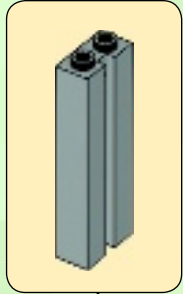

10

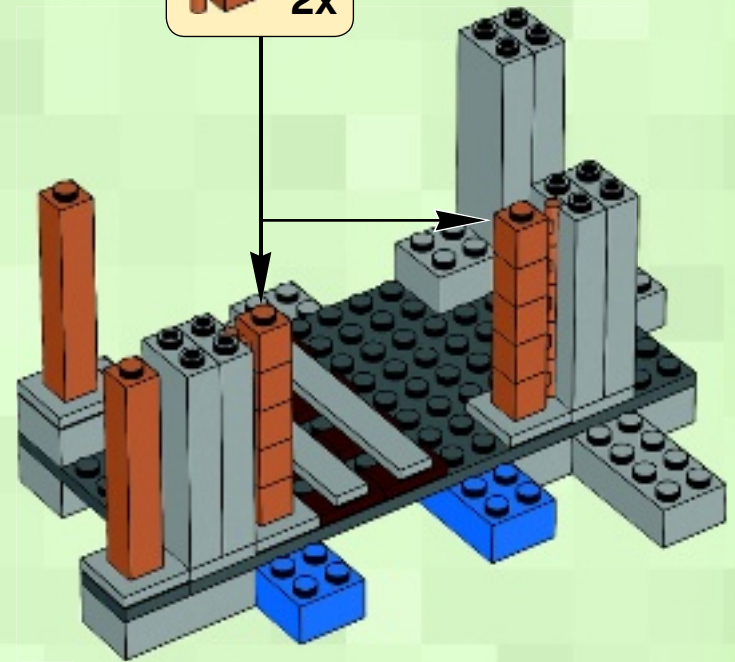
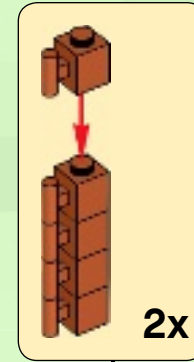

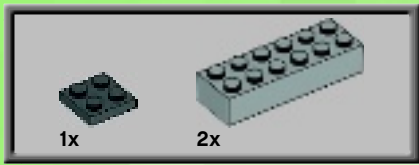

11

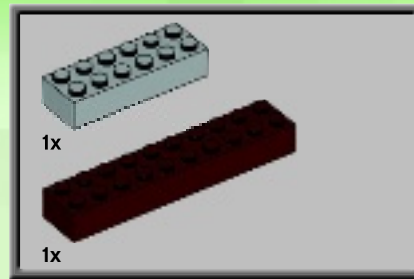
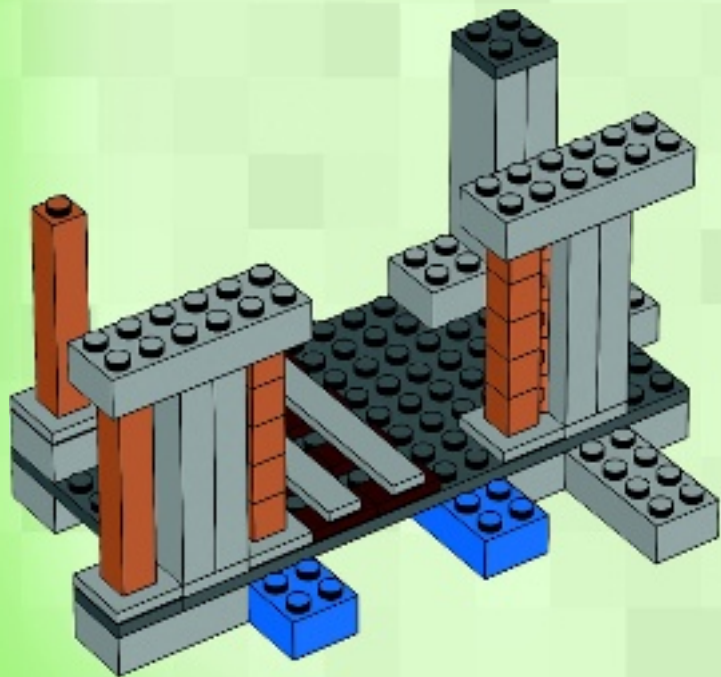

12

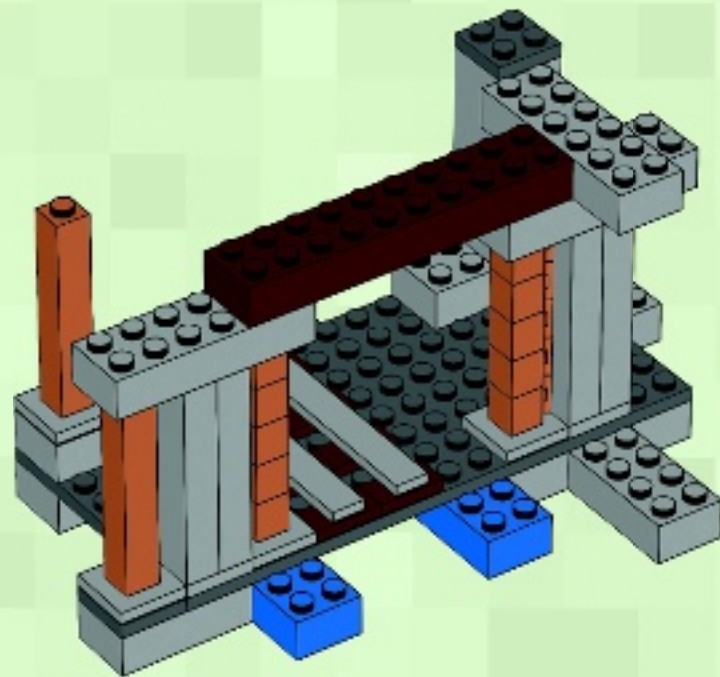

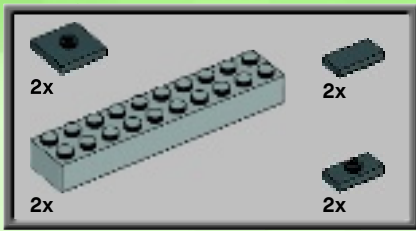

13

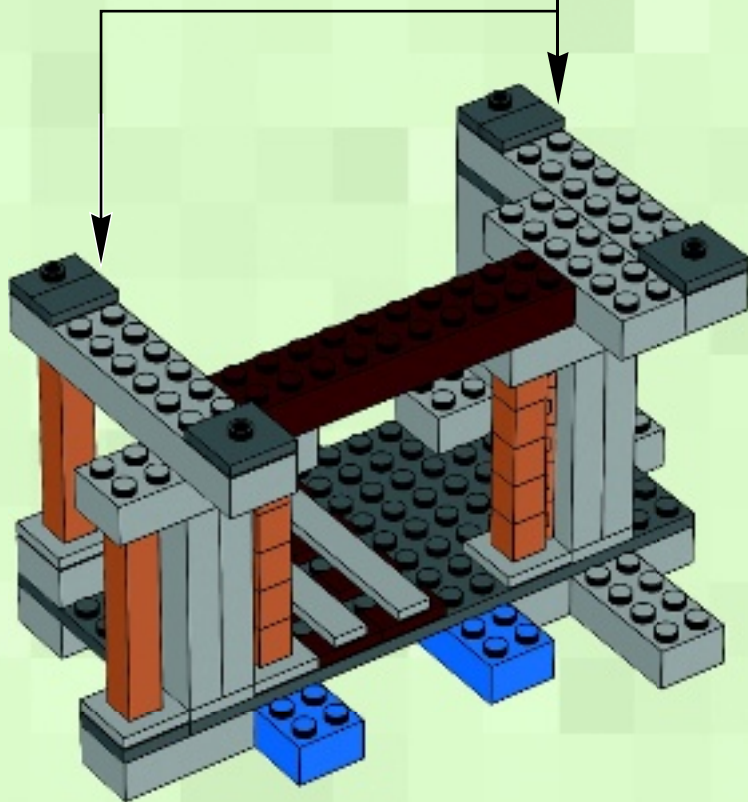
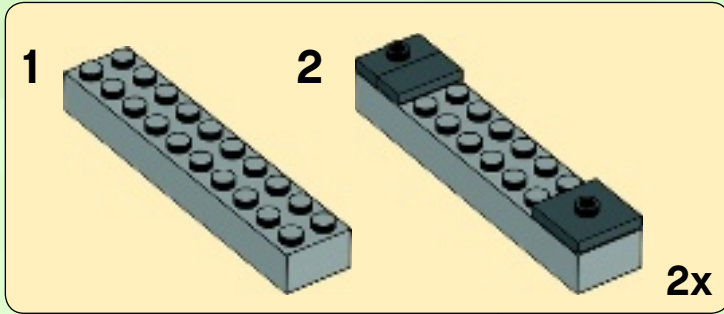

14

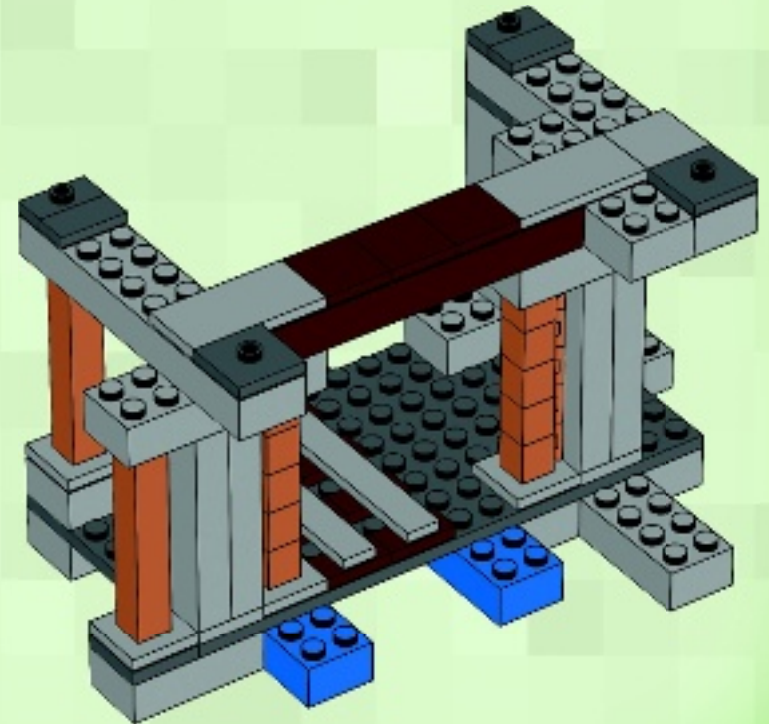

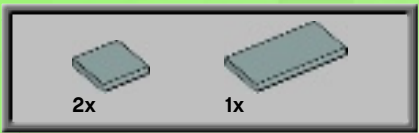

15

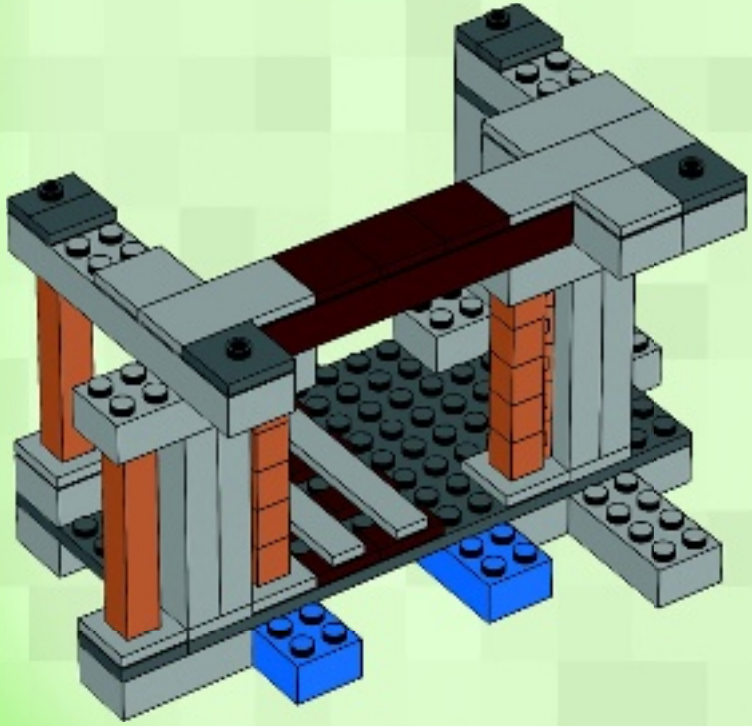

16

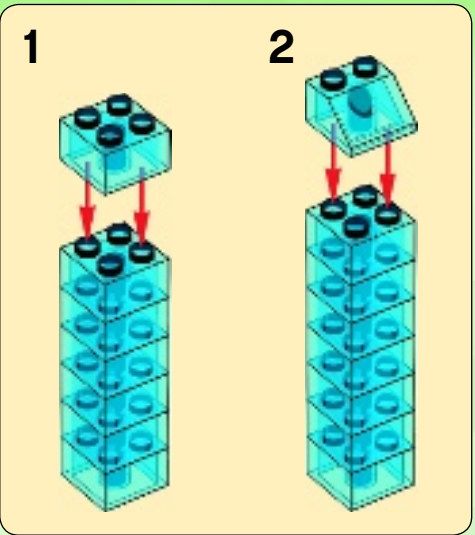
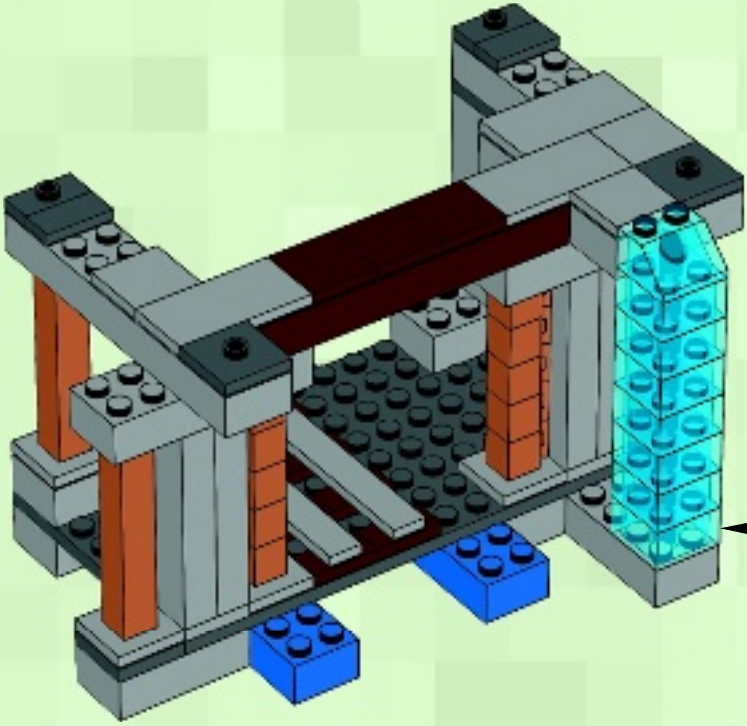

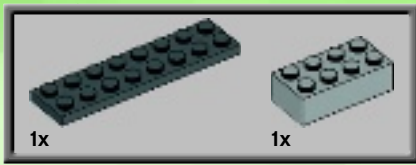

17

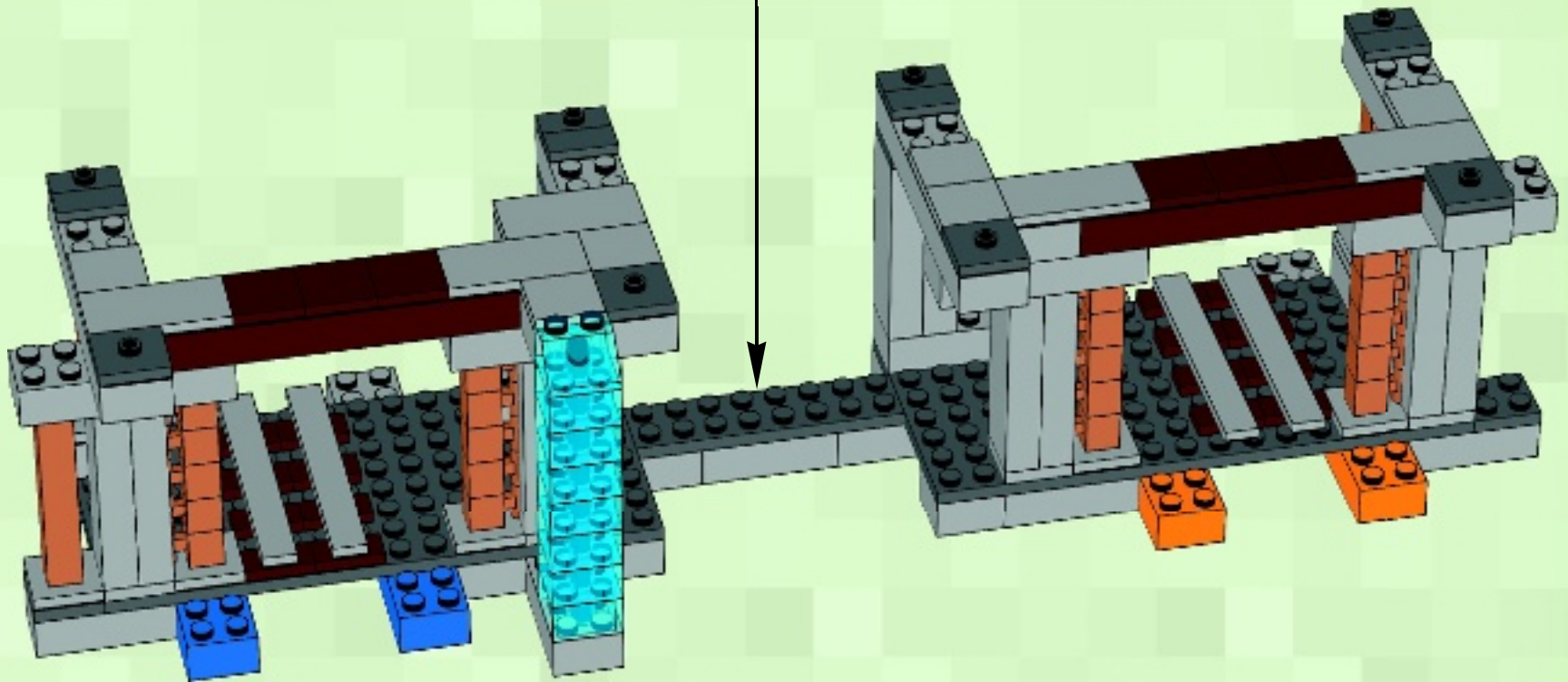
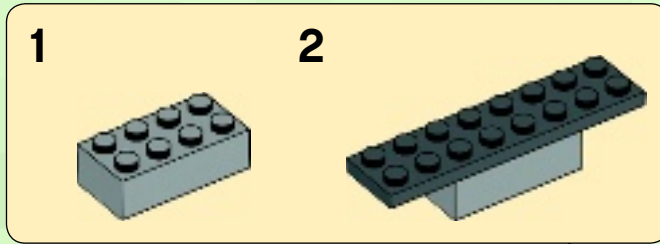

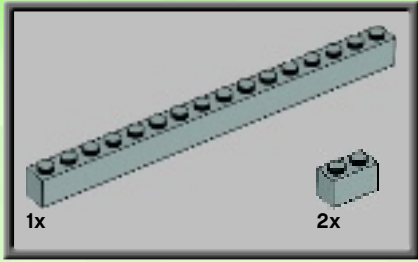
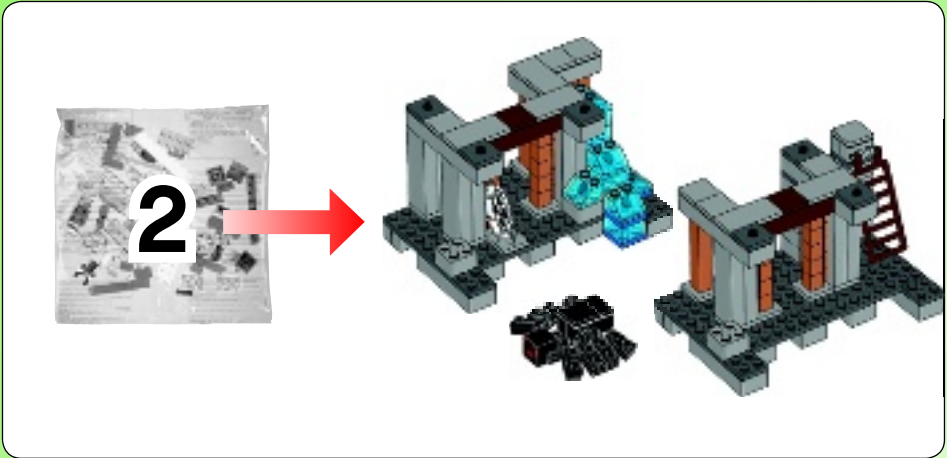

2

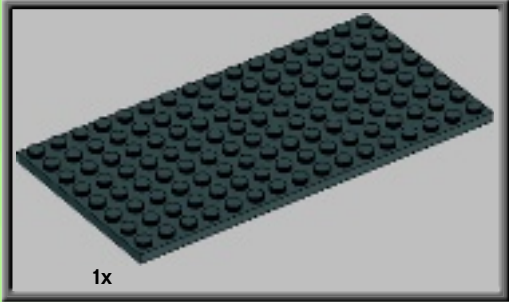

1

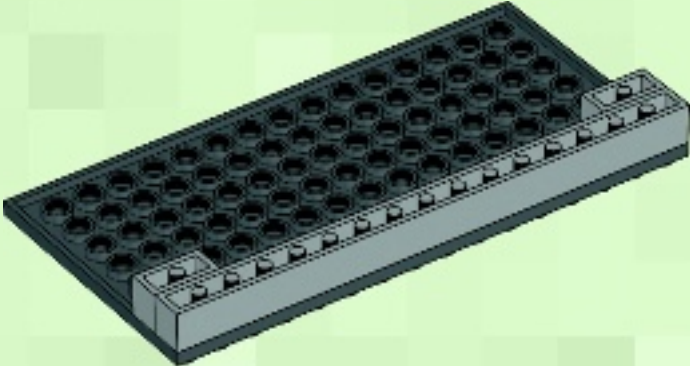

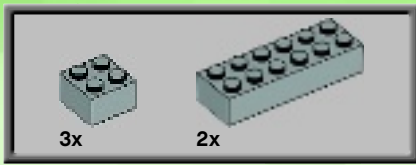

3

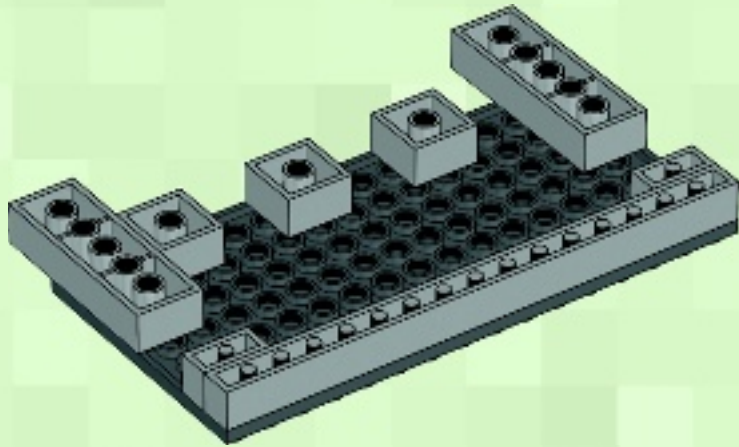

4

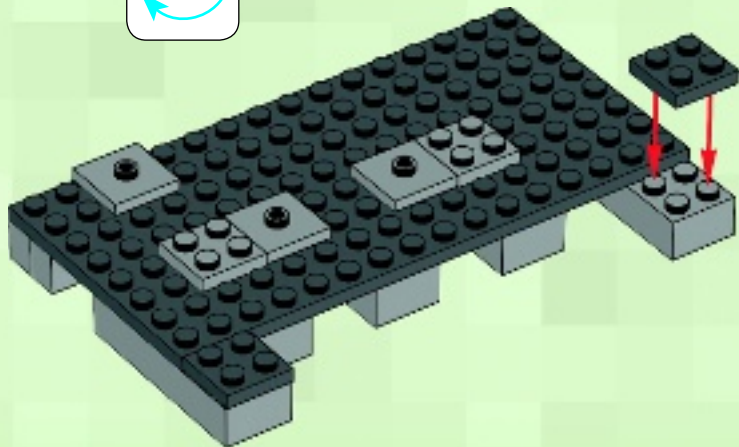
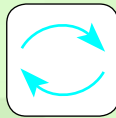

5

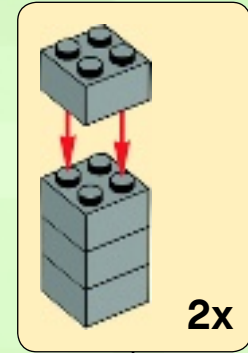

2x

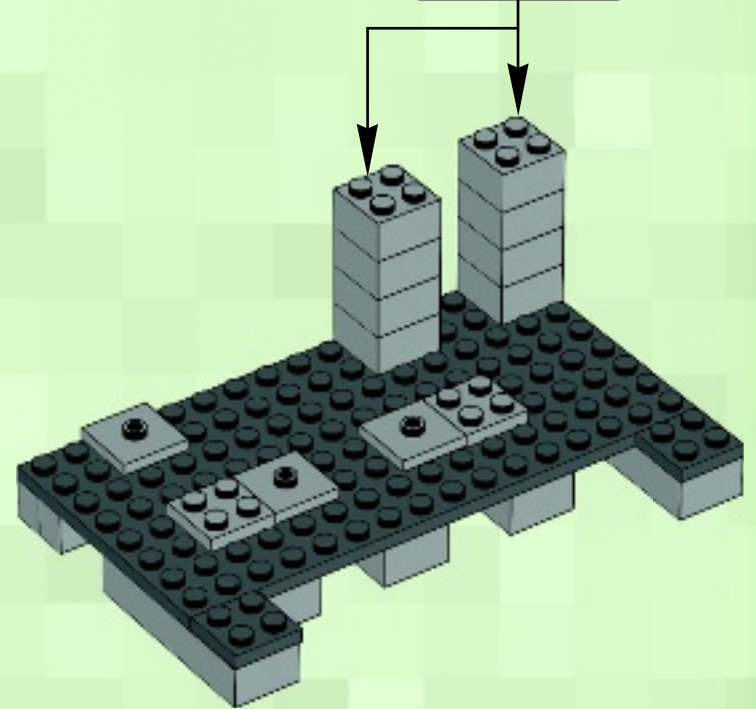

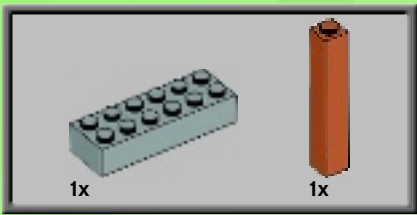

6

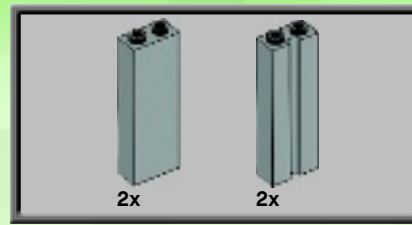
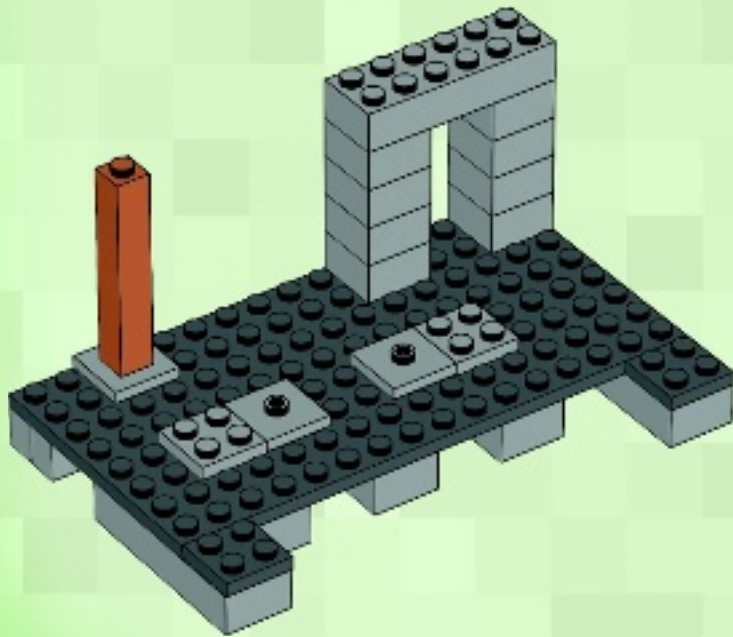

7

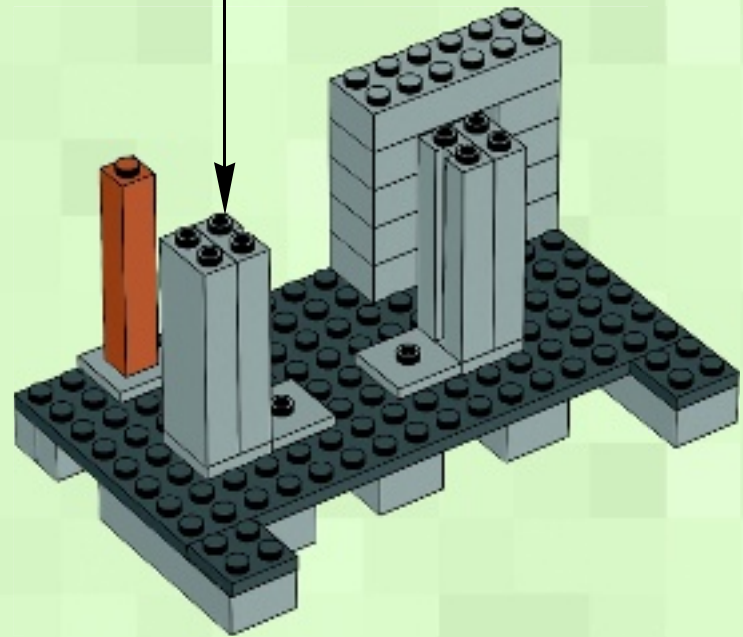
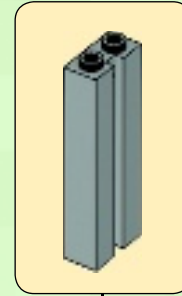

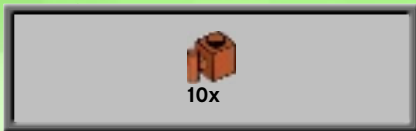

8

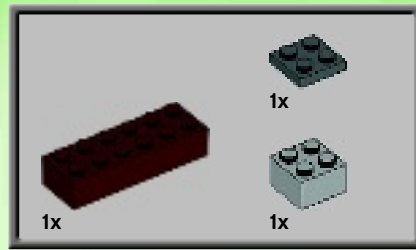
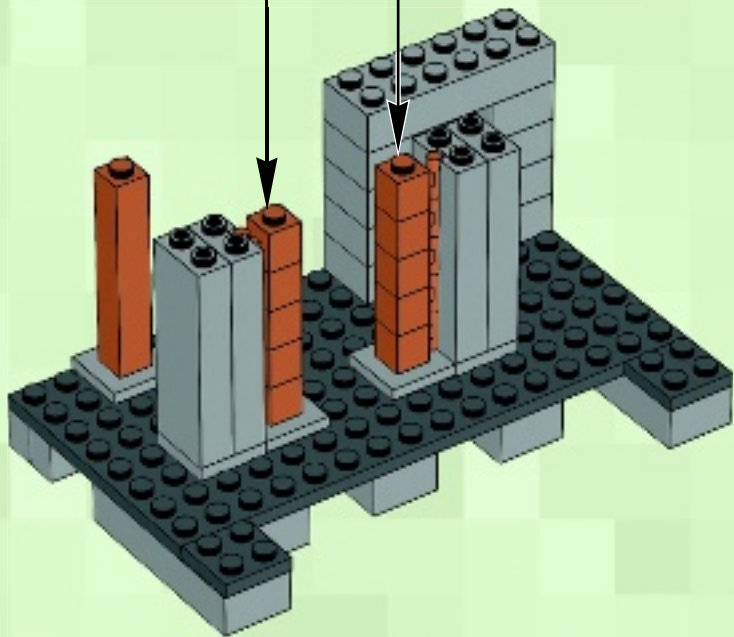
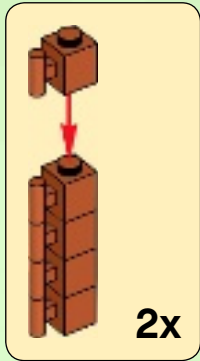

9

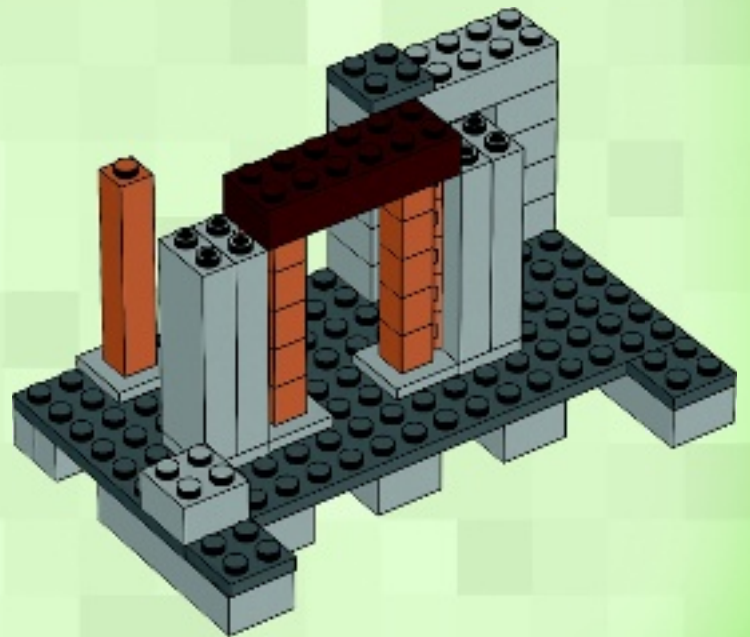

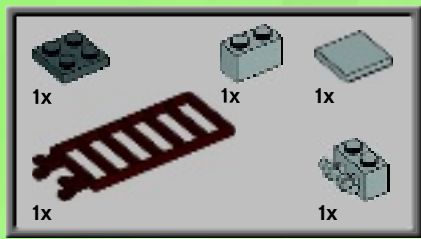

10

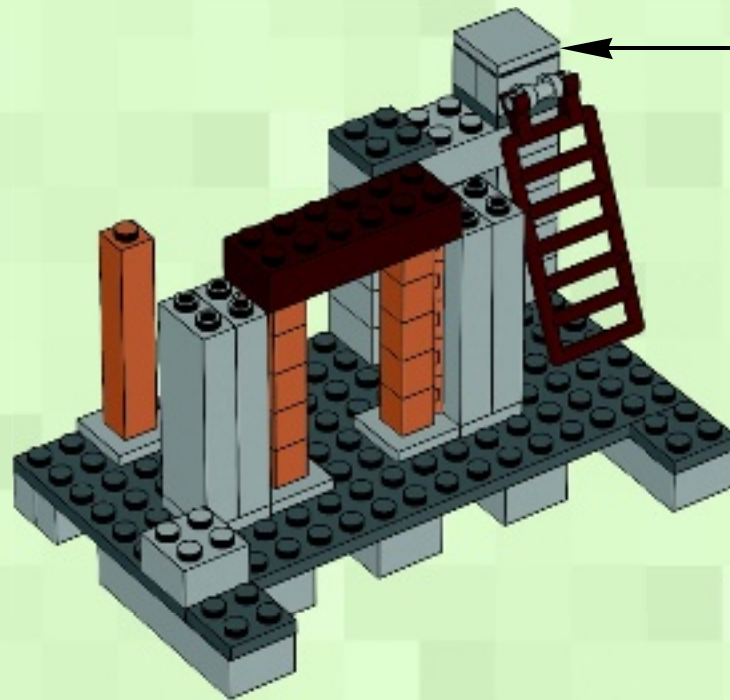
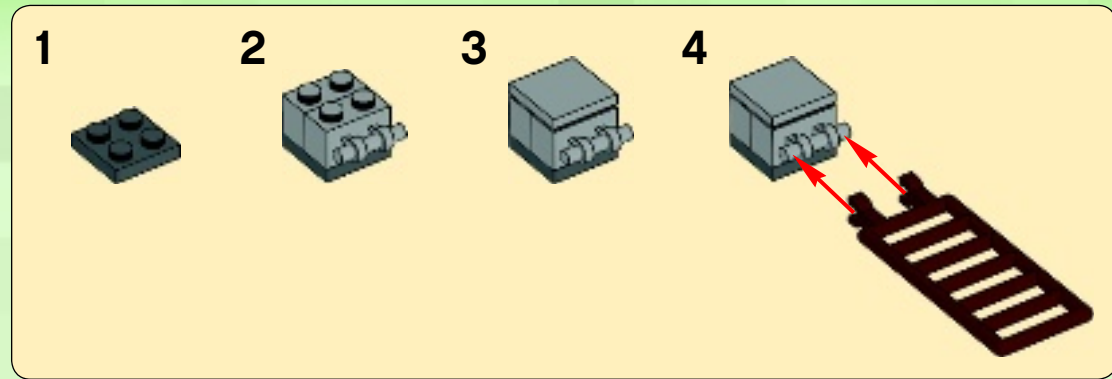

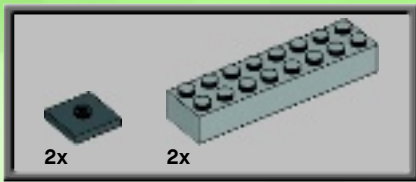

11

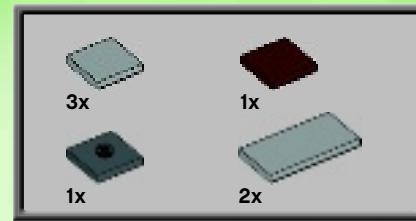
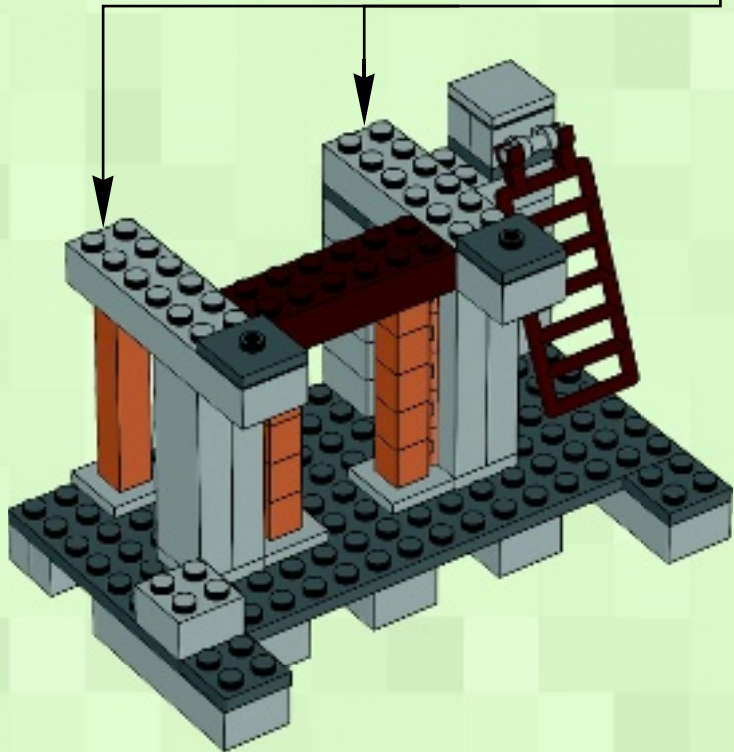
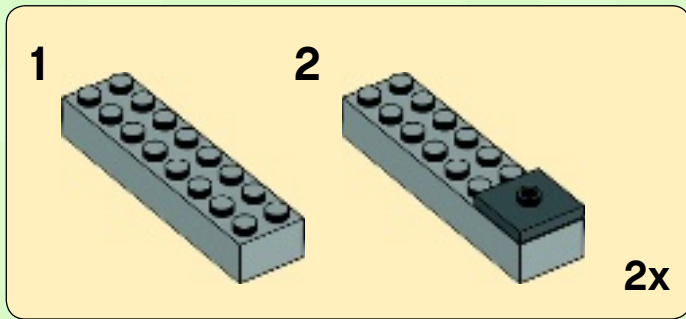

12

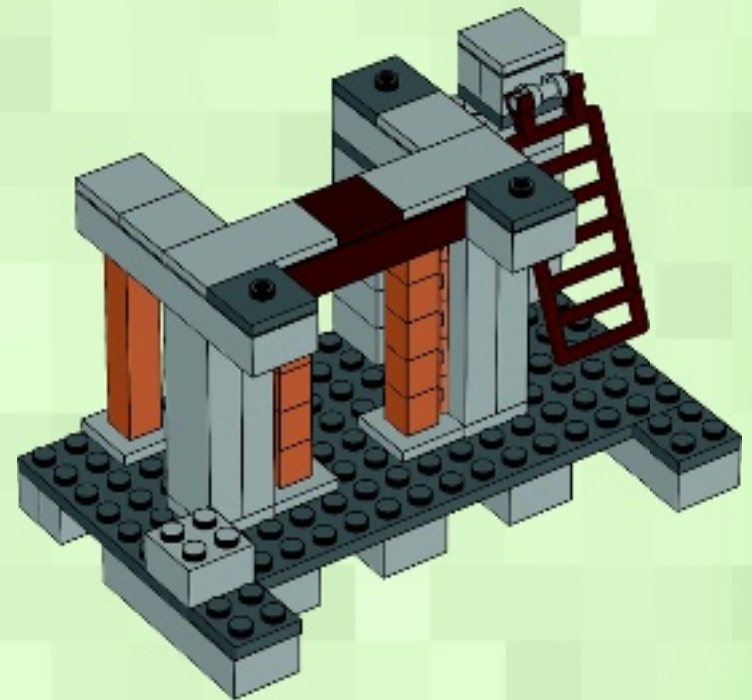

13

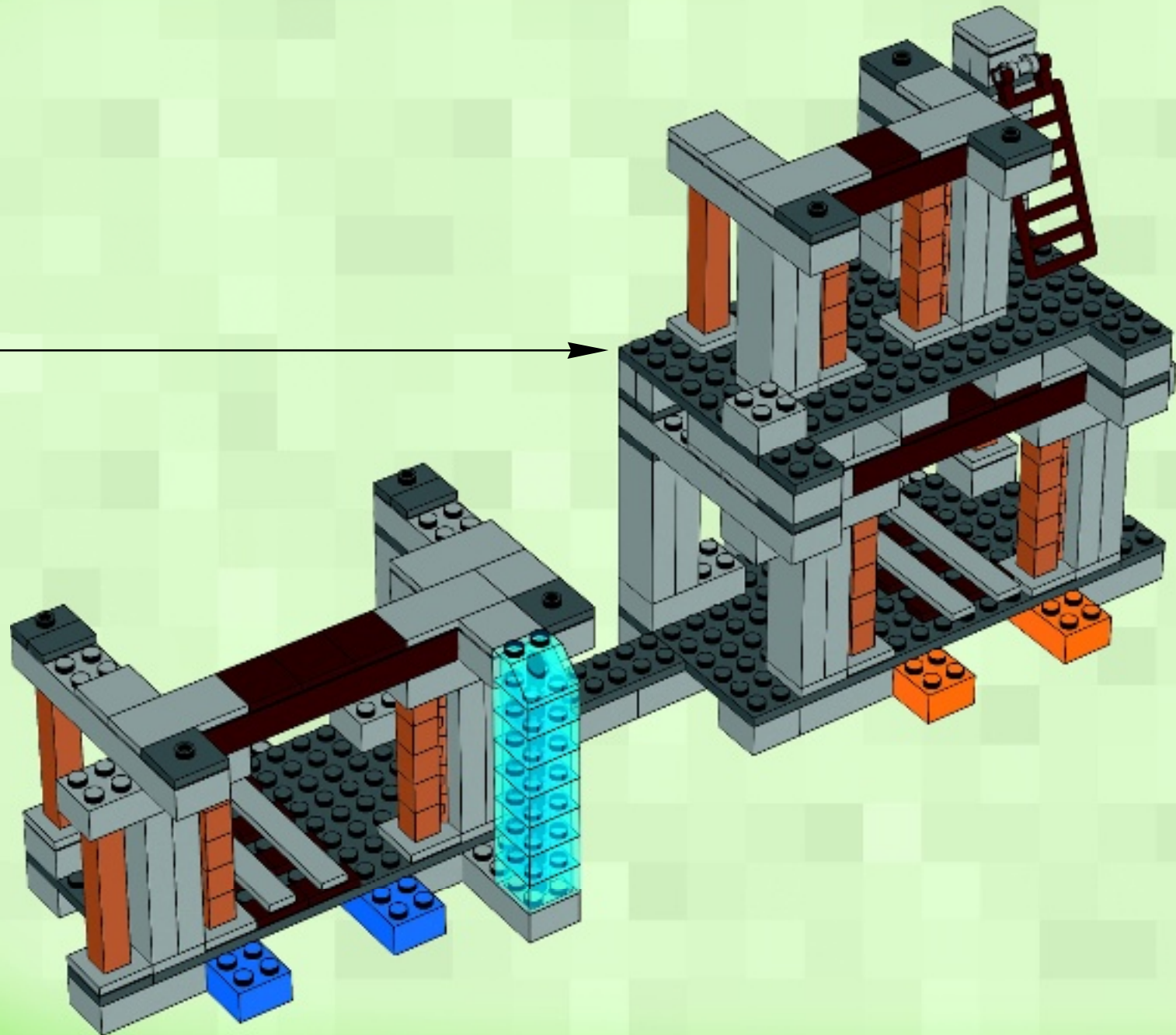



1



2



3

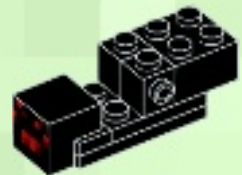

4





2x

5



2x

2x

2x

6



1

2

2x



2x

2x

2x

7

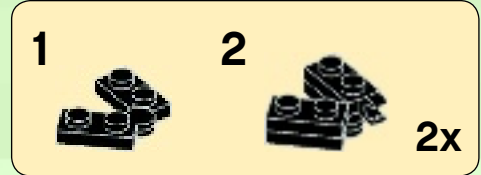

1

2

2x

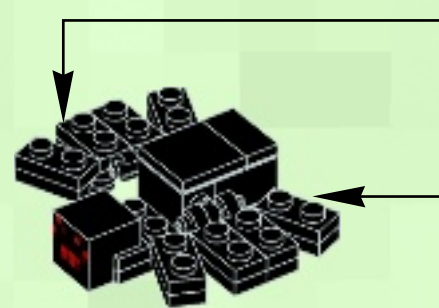

8



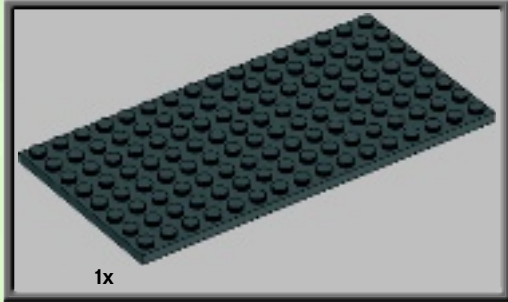
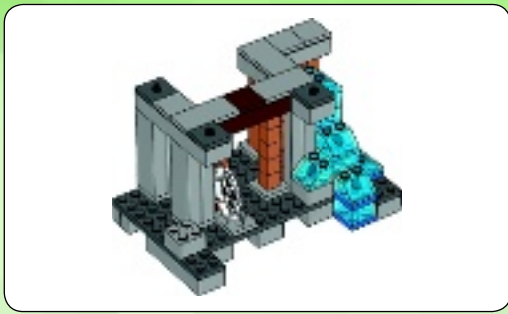

1

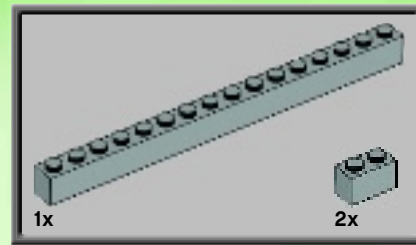

2

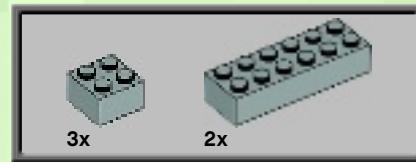
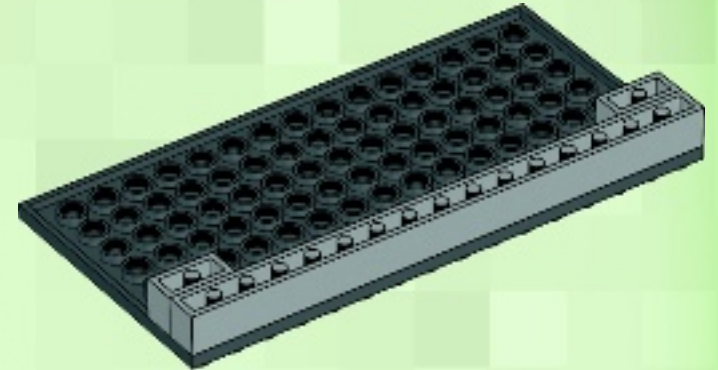

3

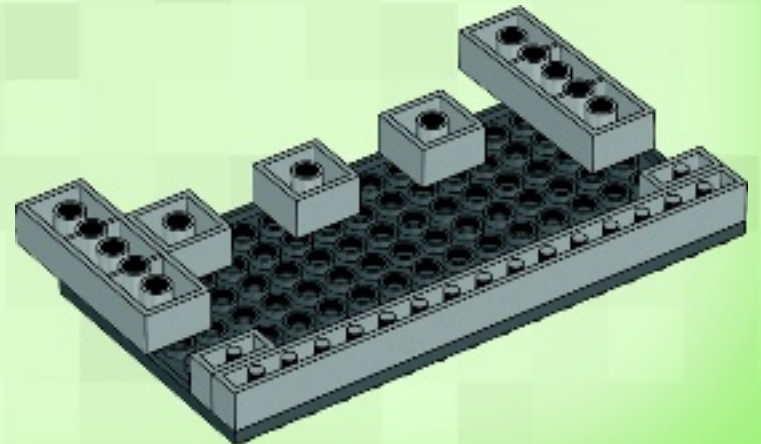



4

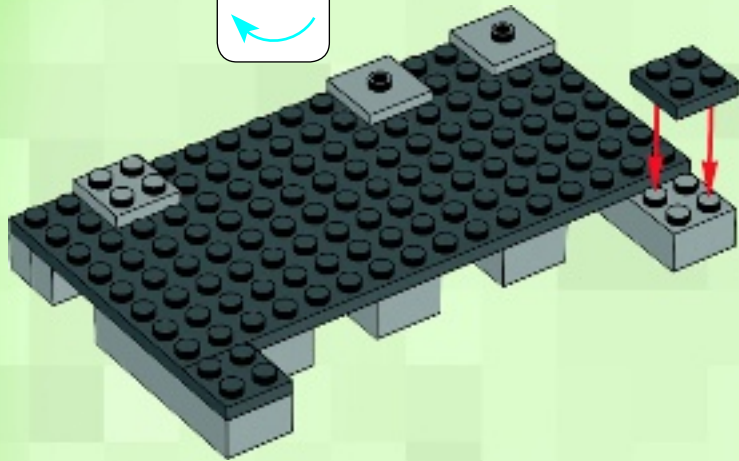

5

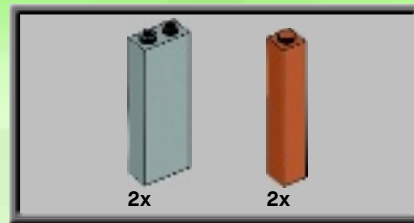
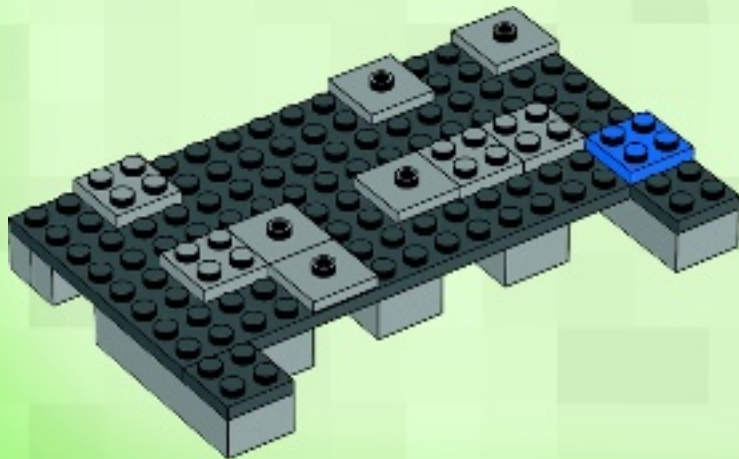

6

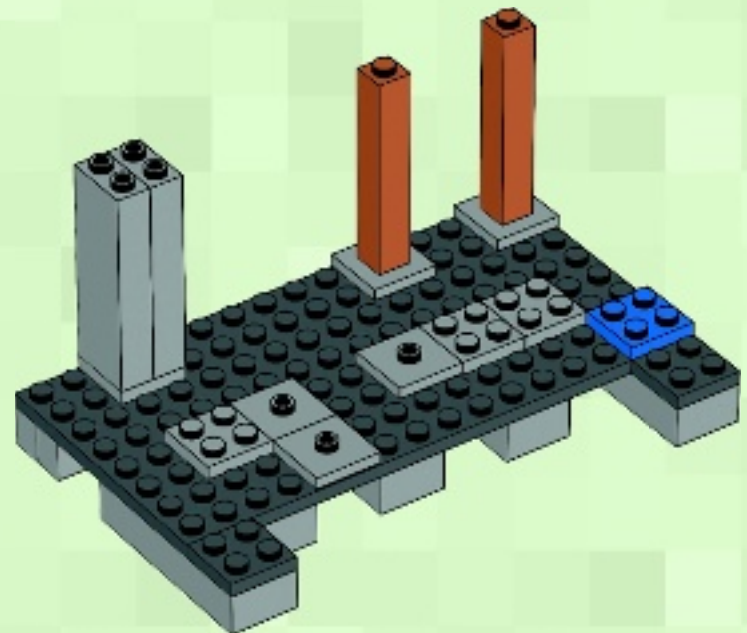

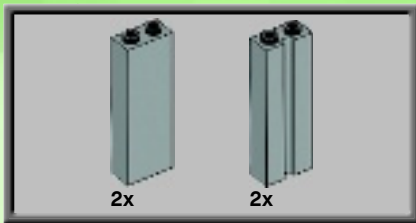

7

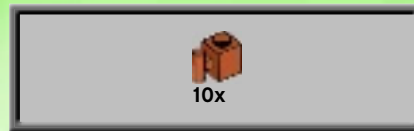
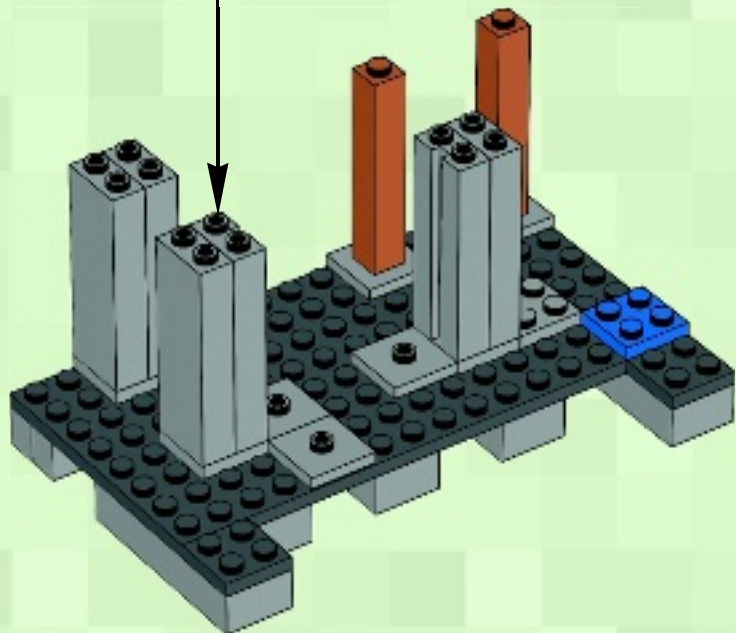
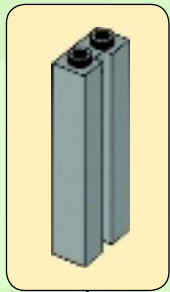

8

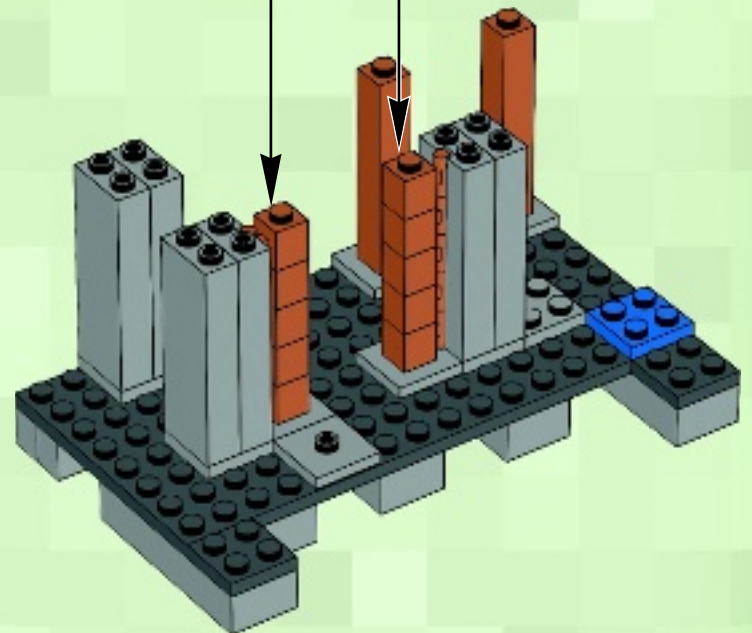
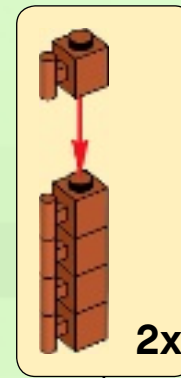



9

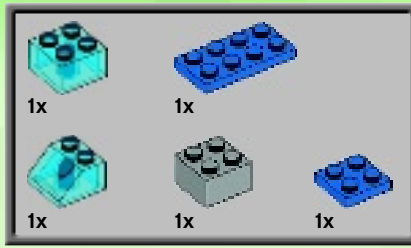
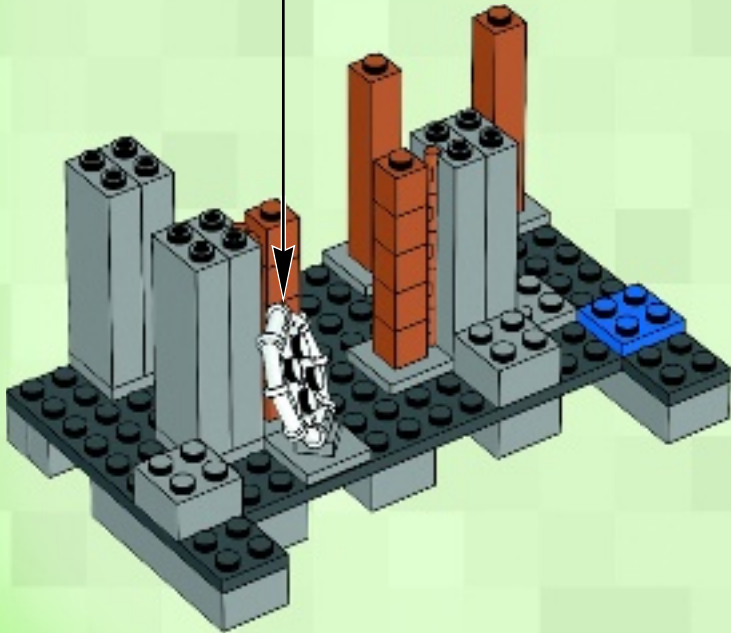
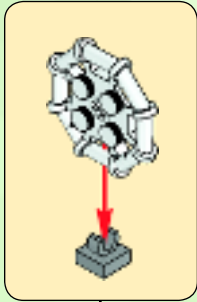

10

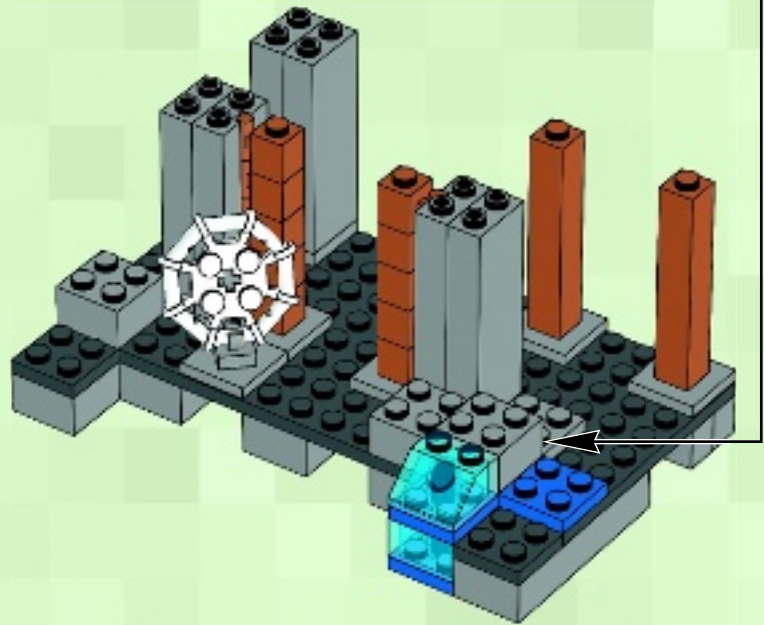
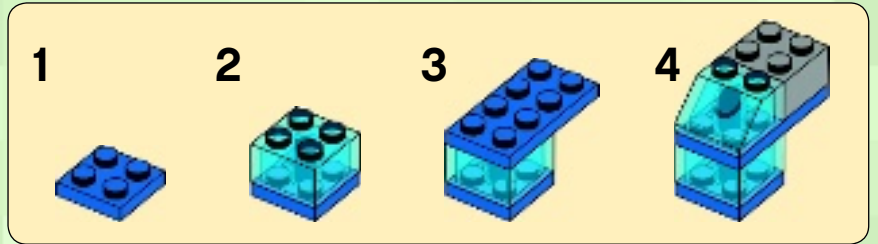

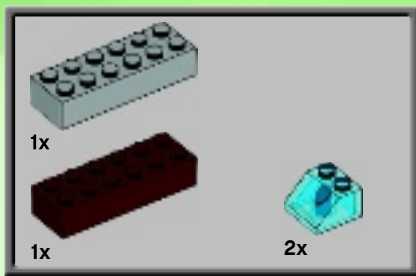

11

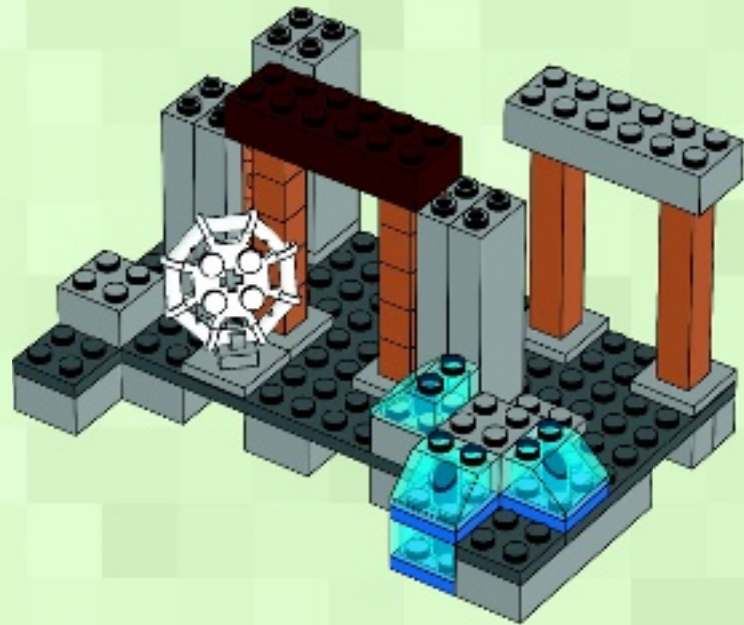

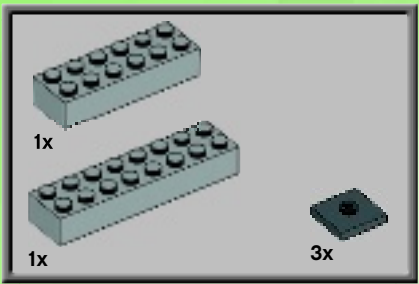

12

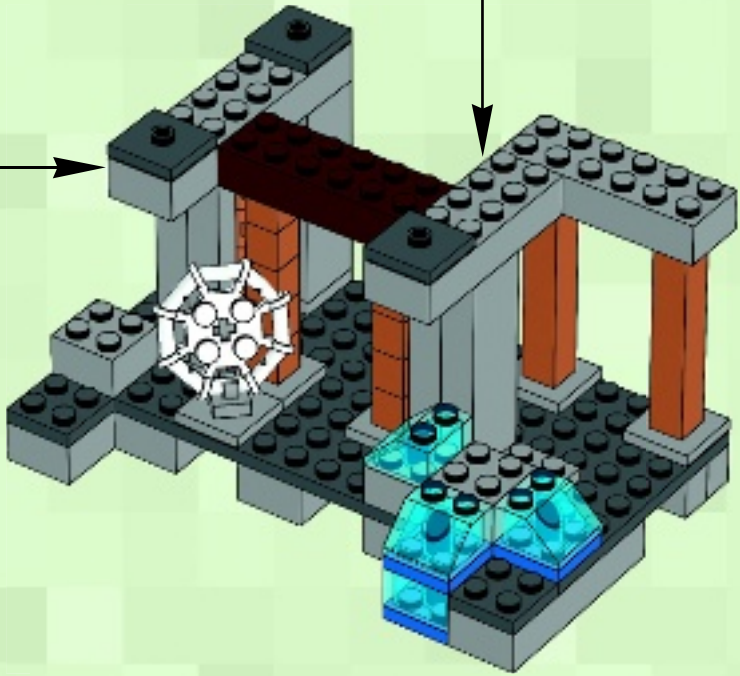
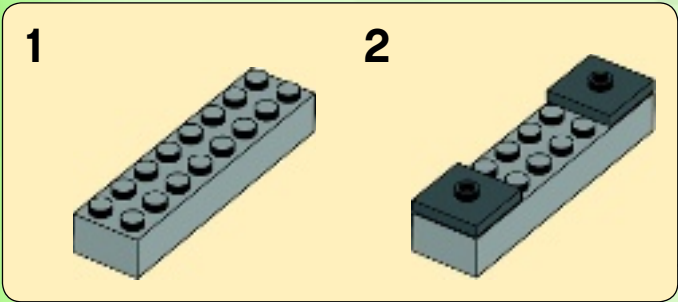
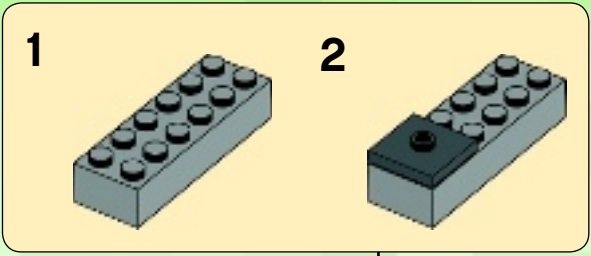

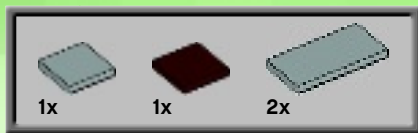

13

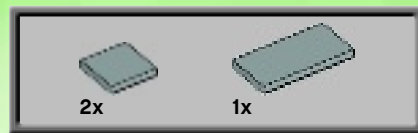
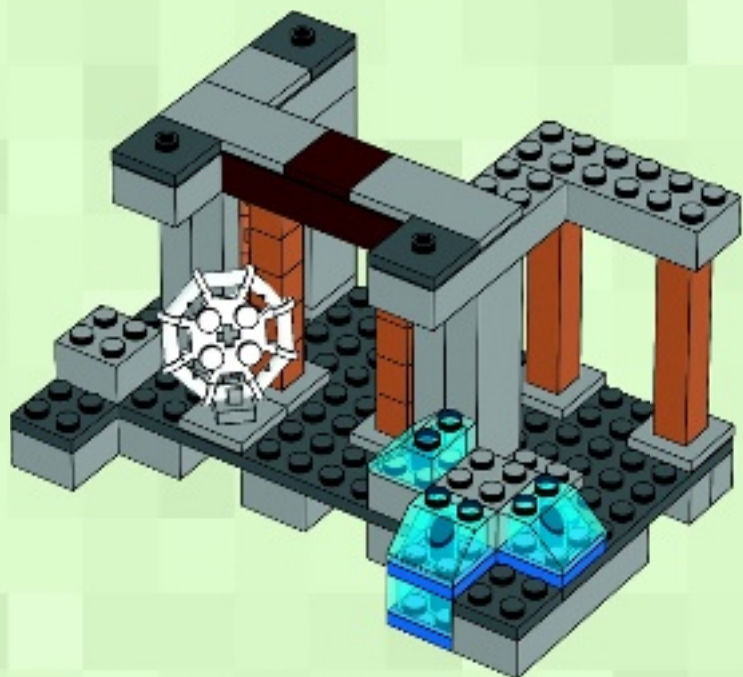

14

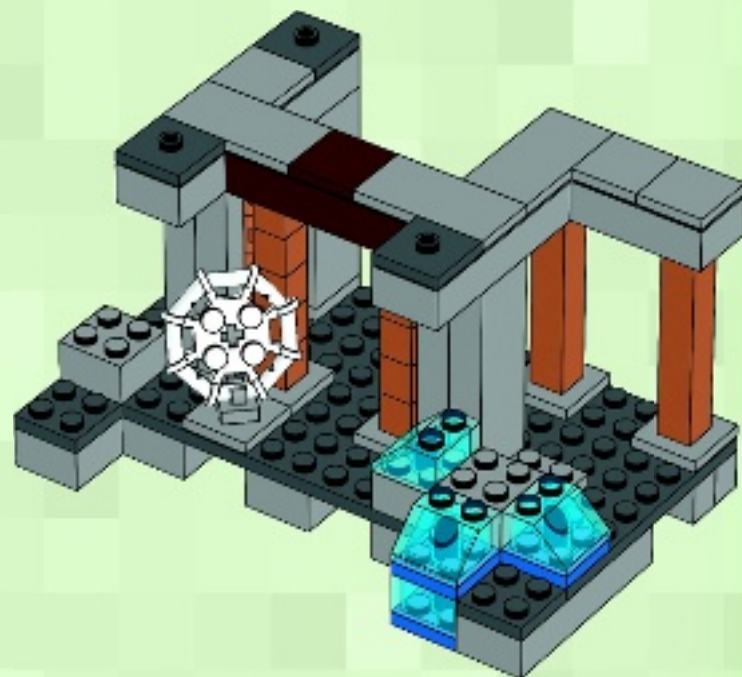



15

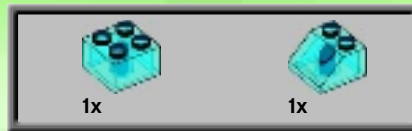
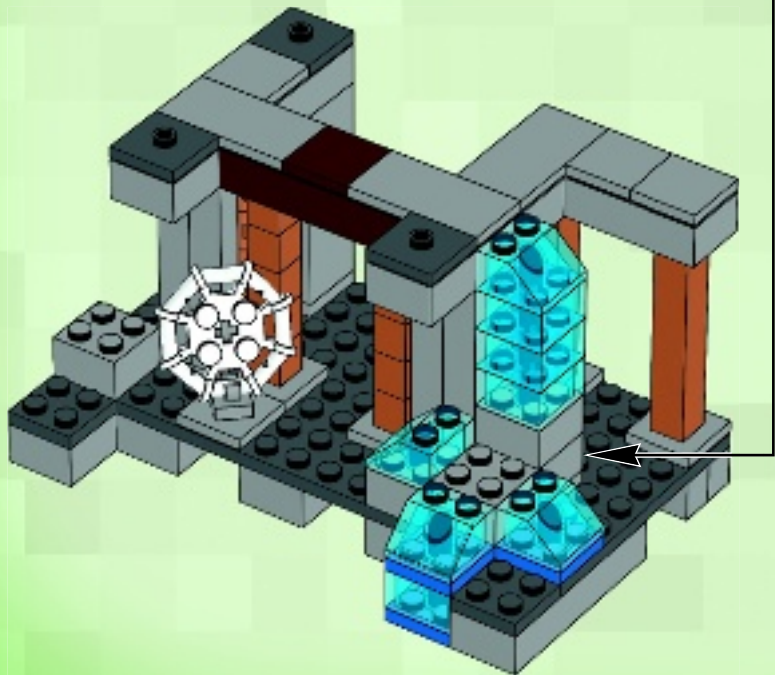
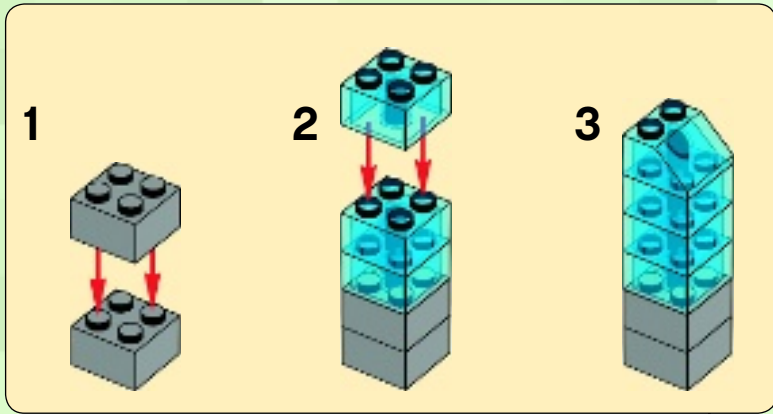

16

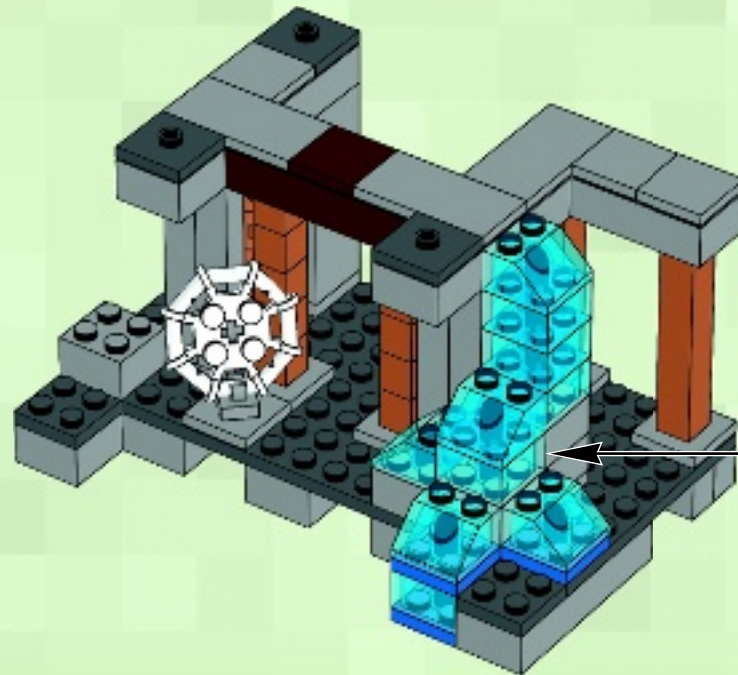
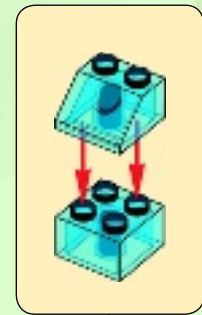

17

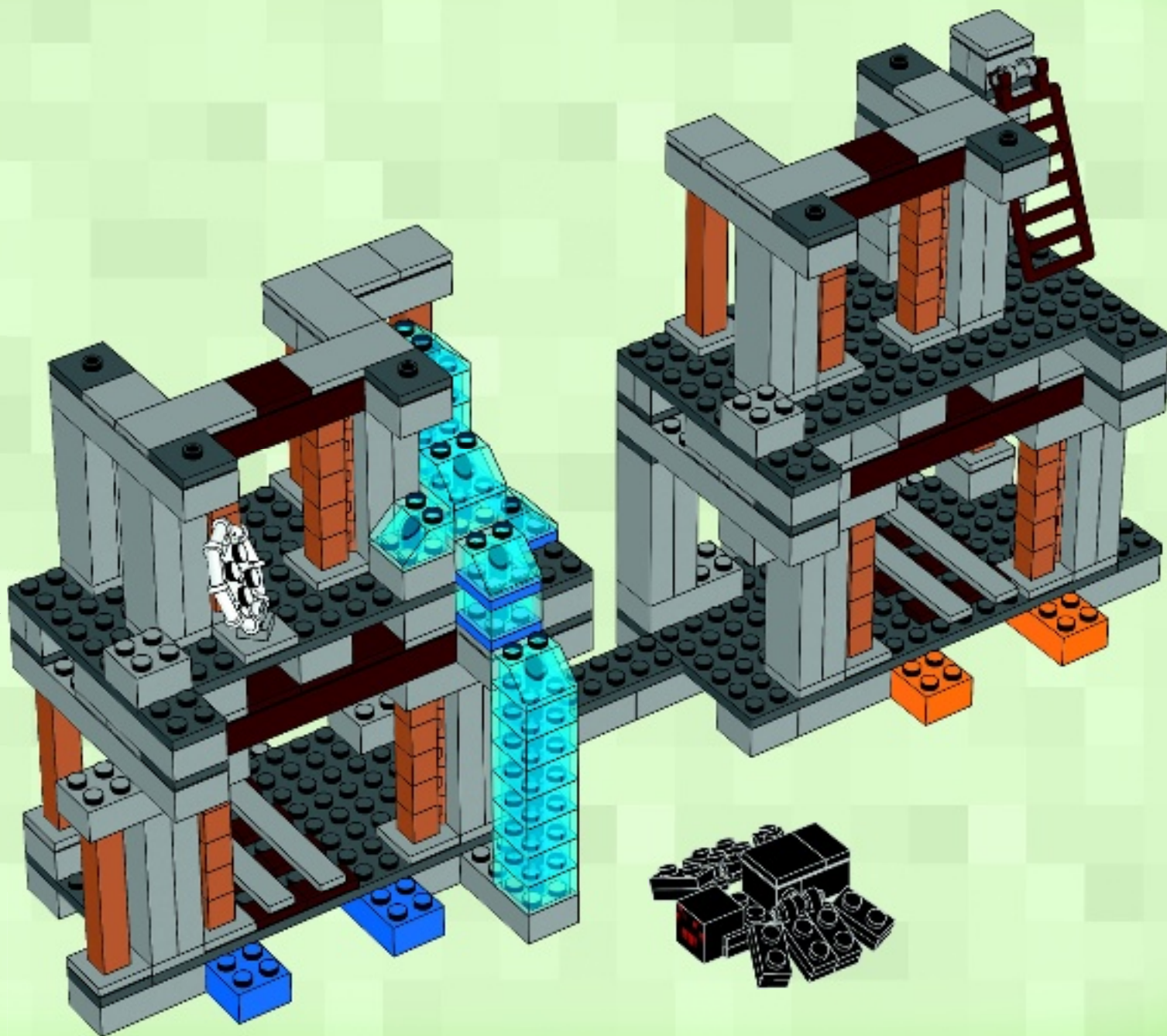

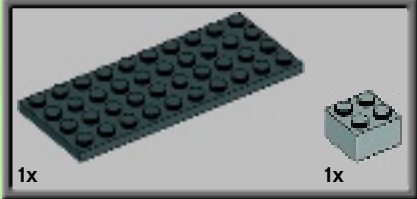

1

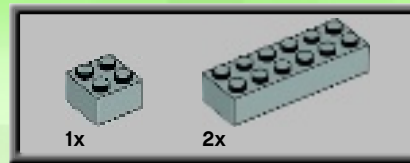
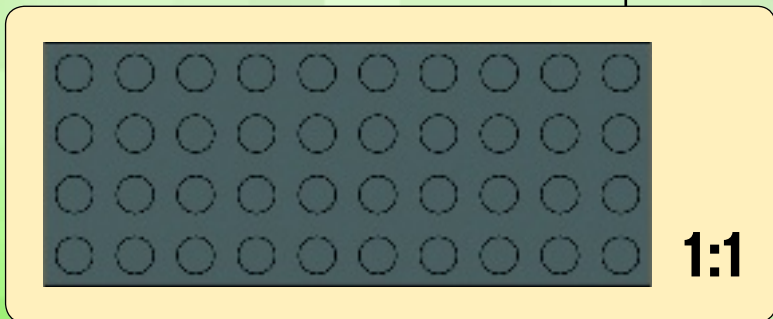
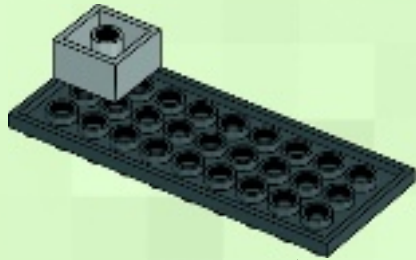

2

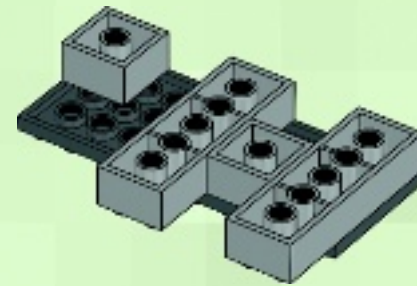

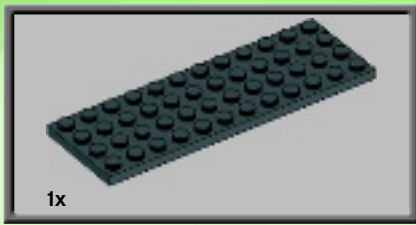

3

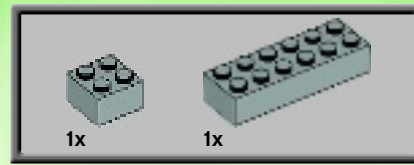
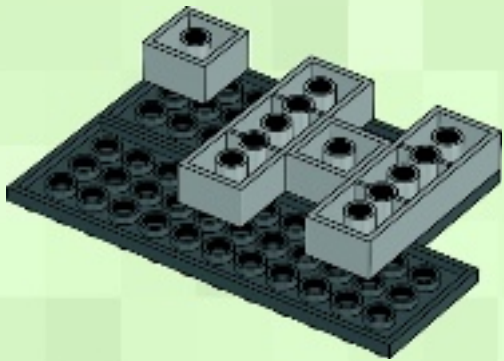

4

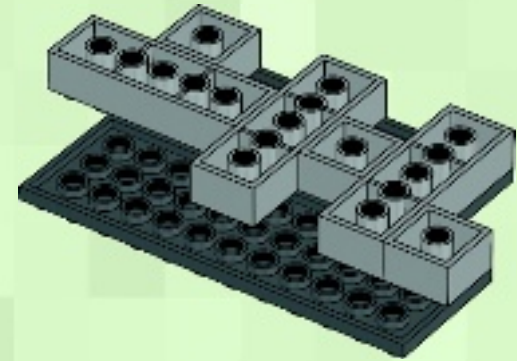

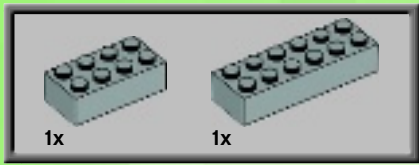

5

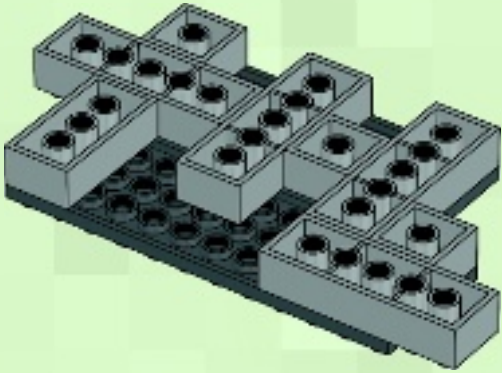

6

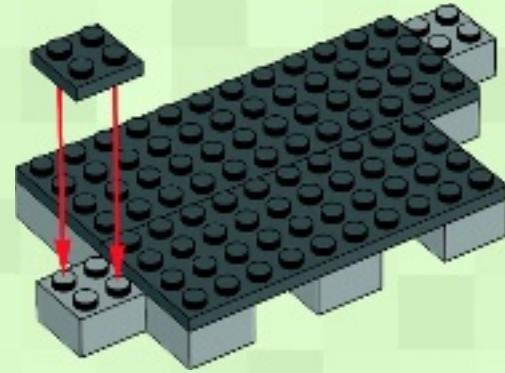
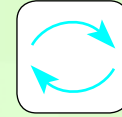



7

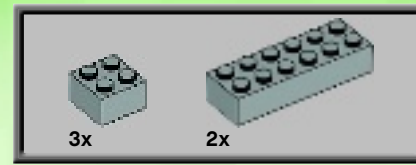
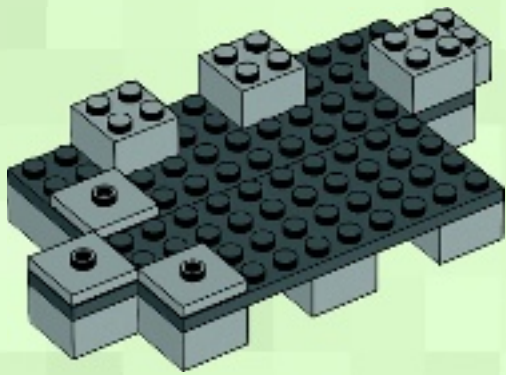

8

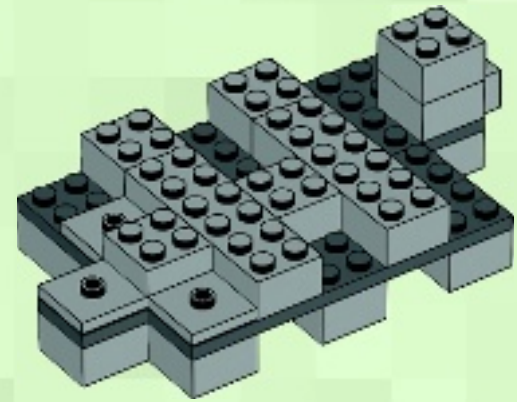



9

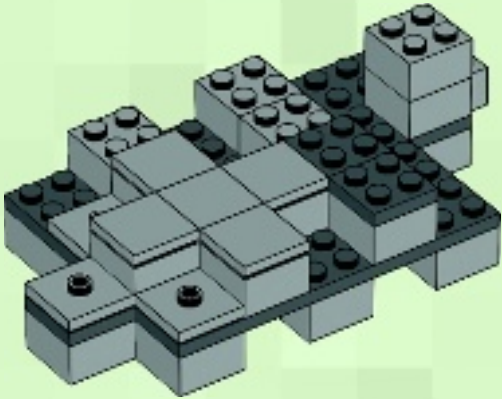

10

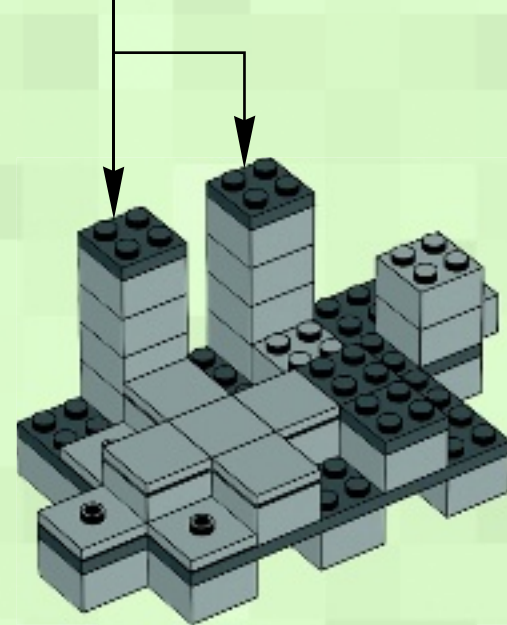
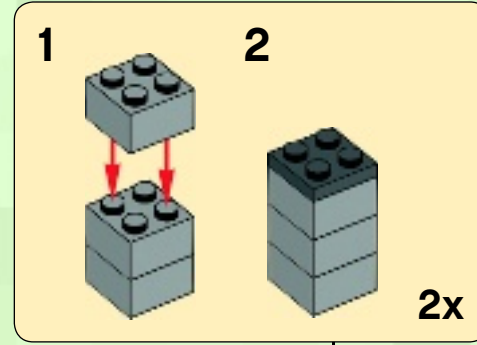



1

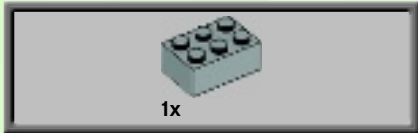

2



3

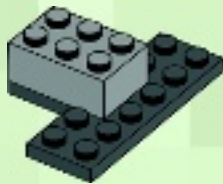

4

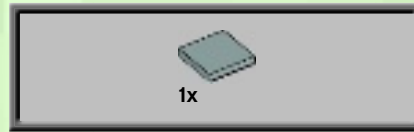

5

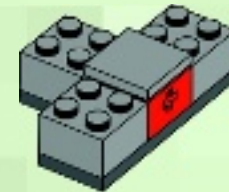

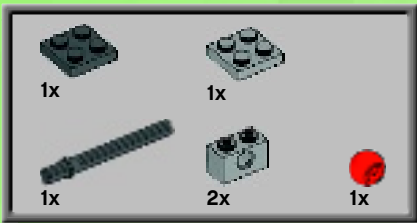

6

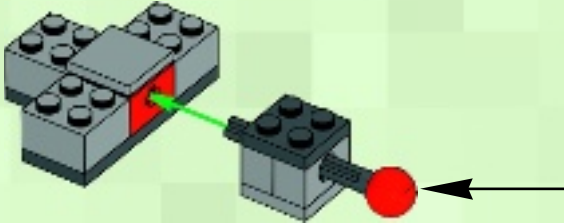
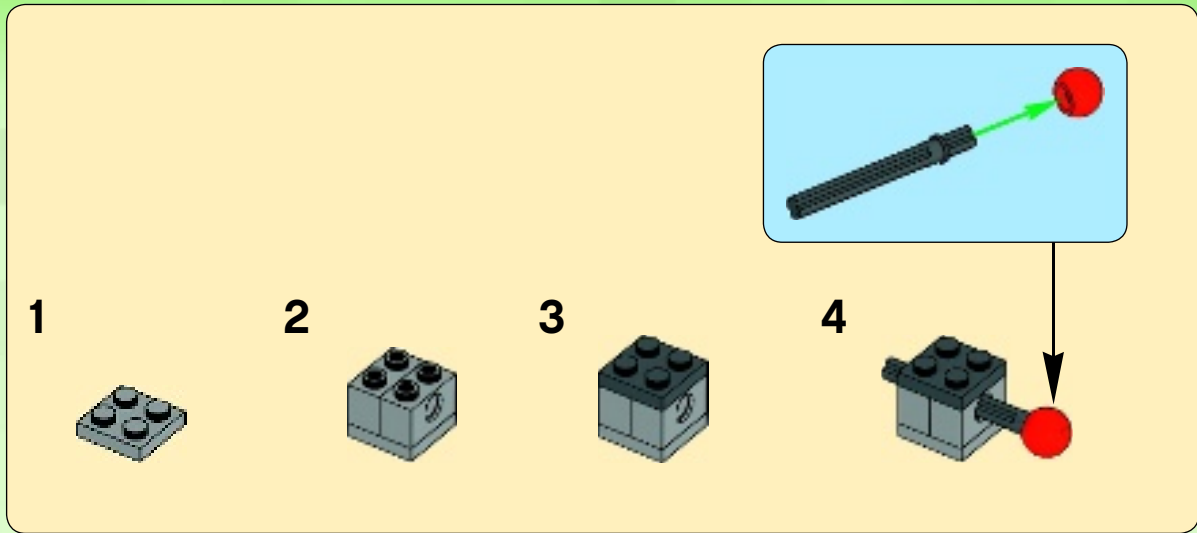

11

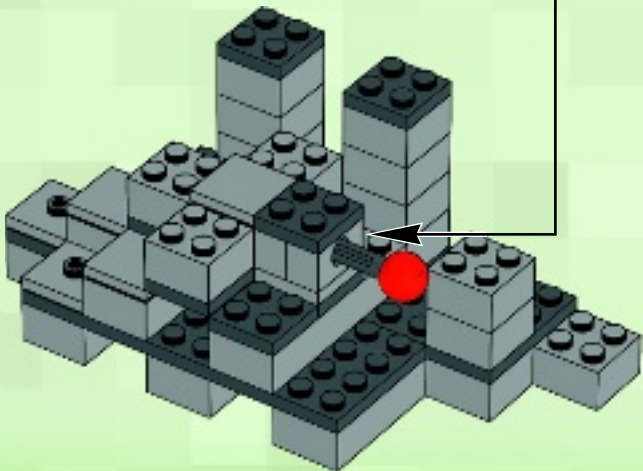



12

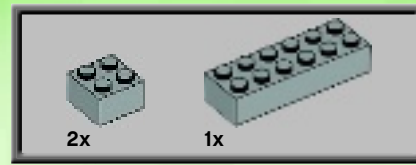
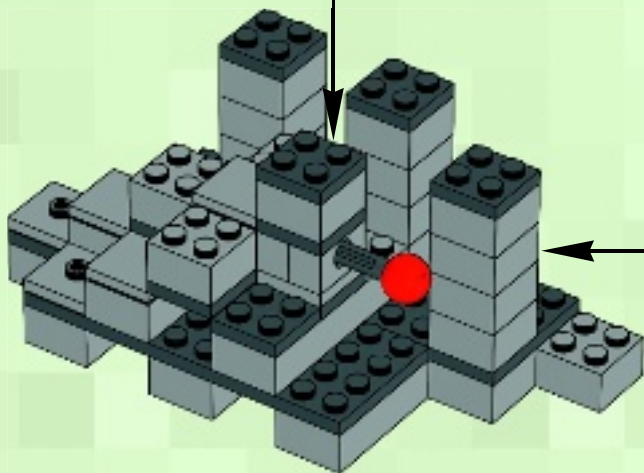
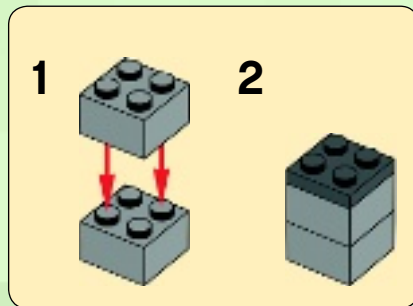
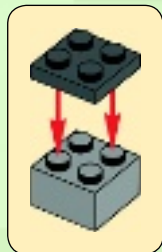

13

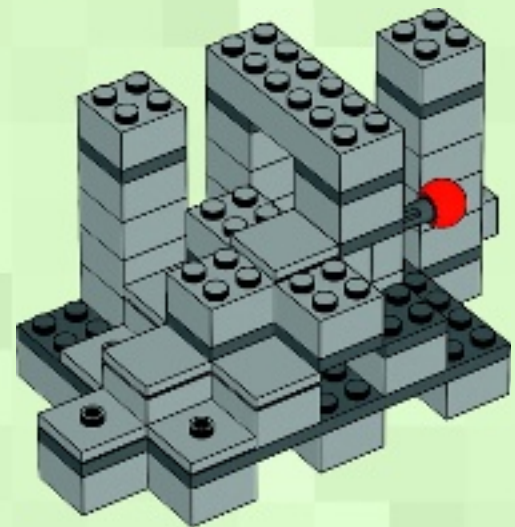



14

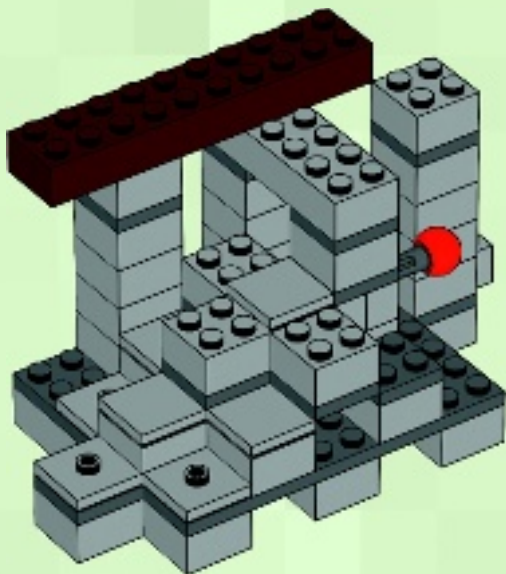

15

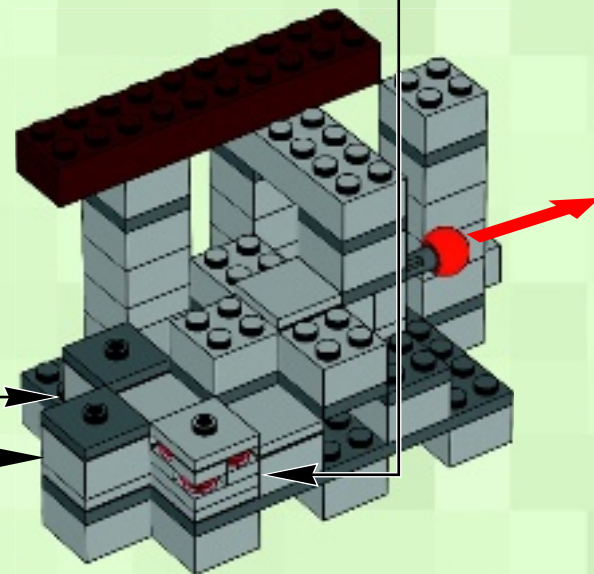
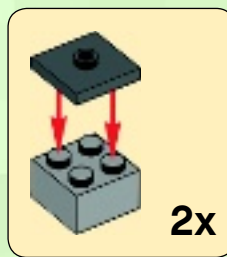



16

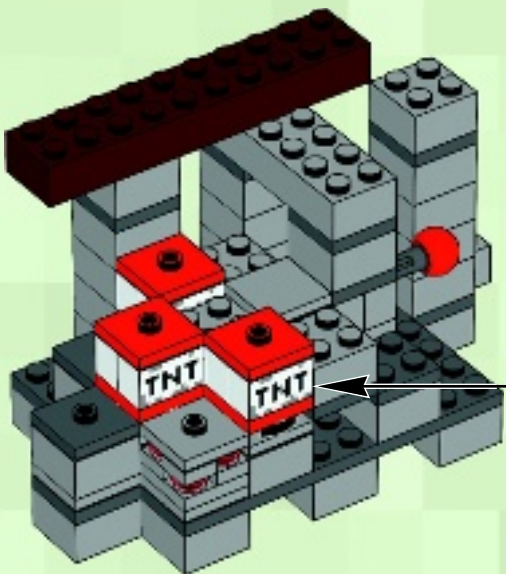

17

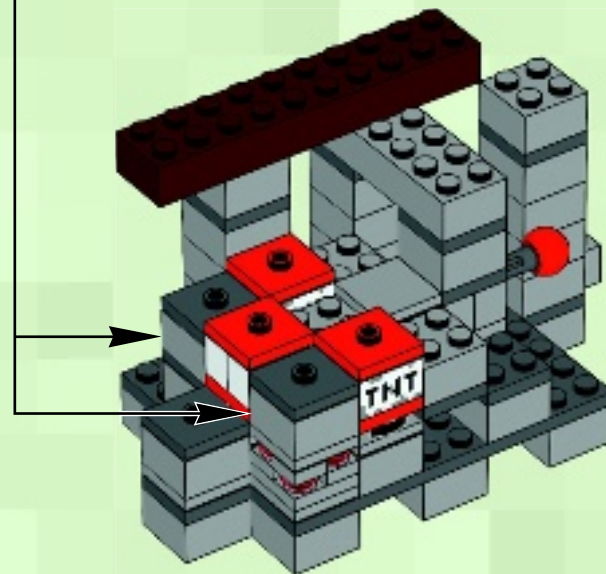
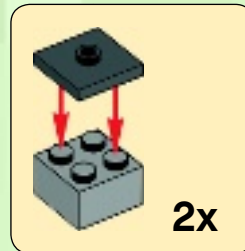



18

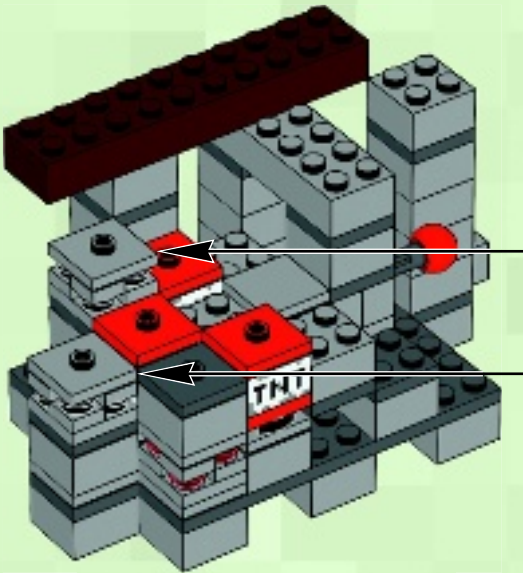
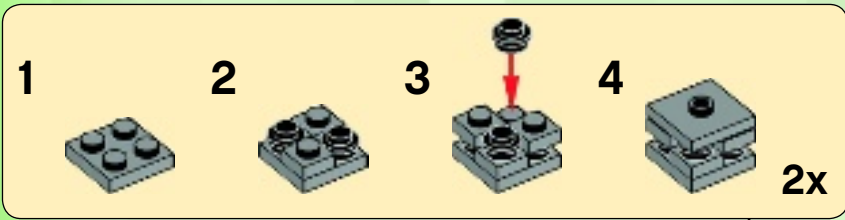

19

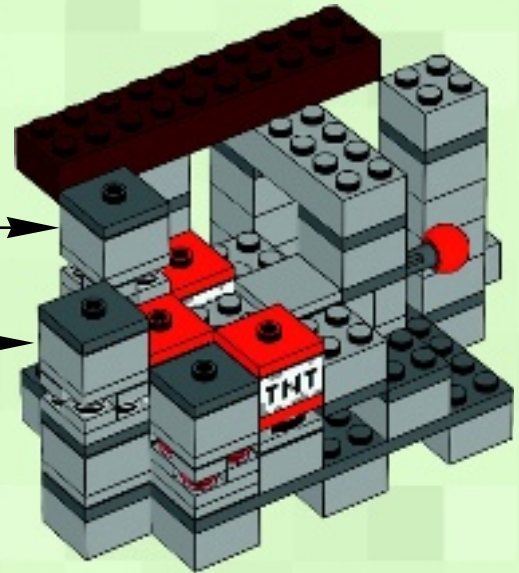
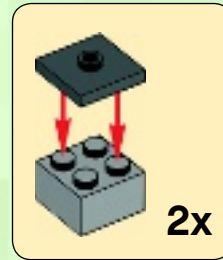

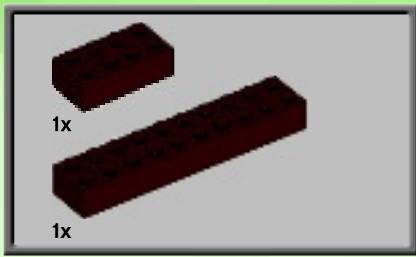

20

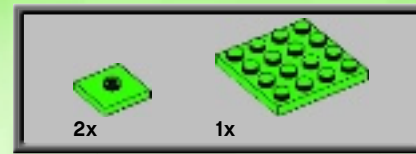
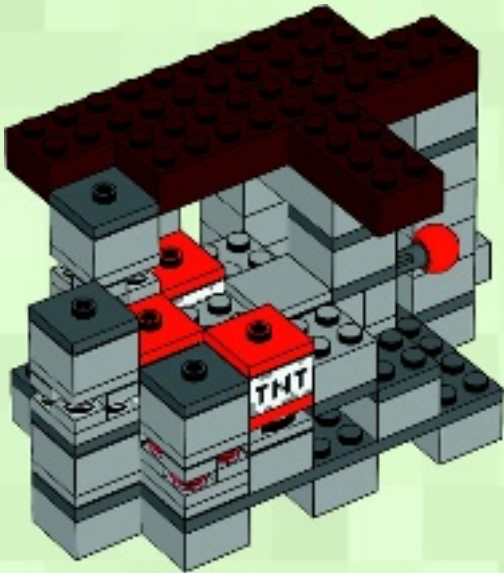

21

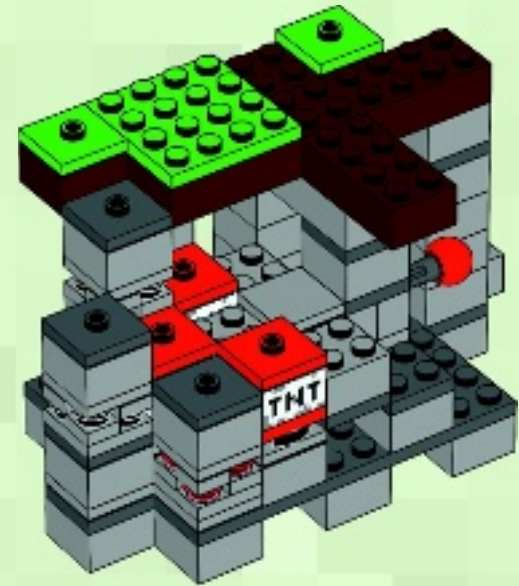

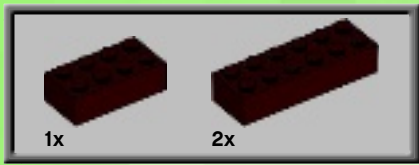

22

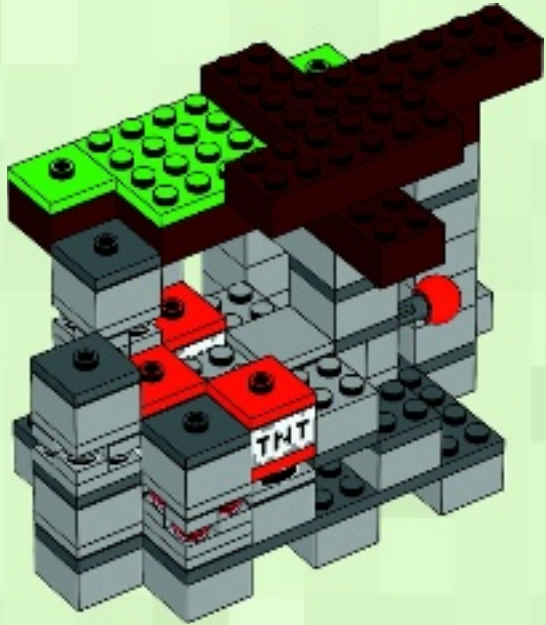

23

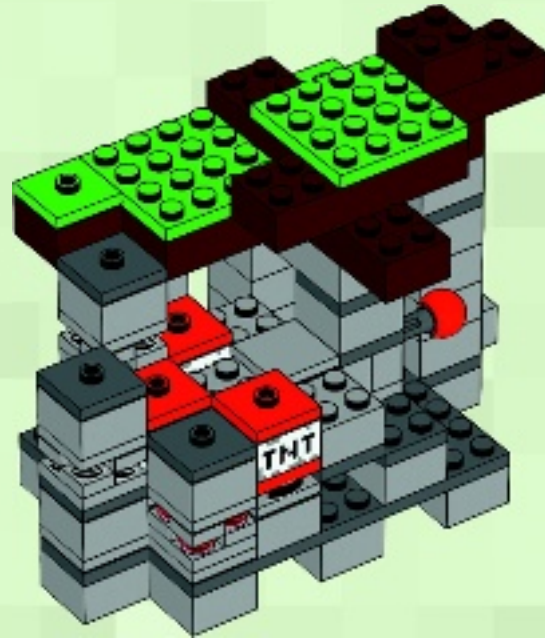



24

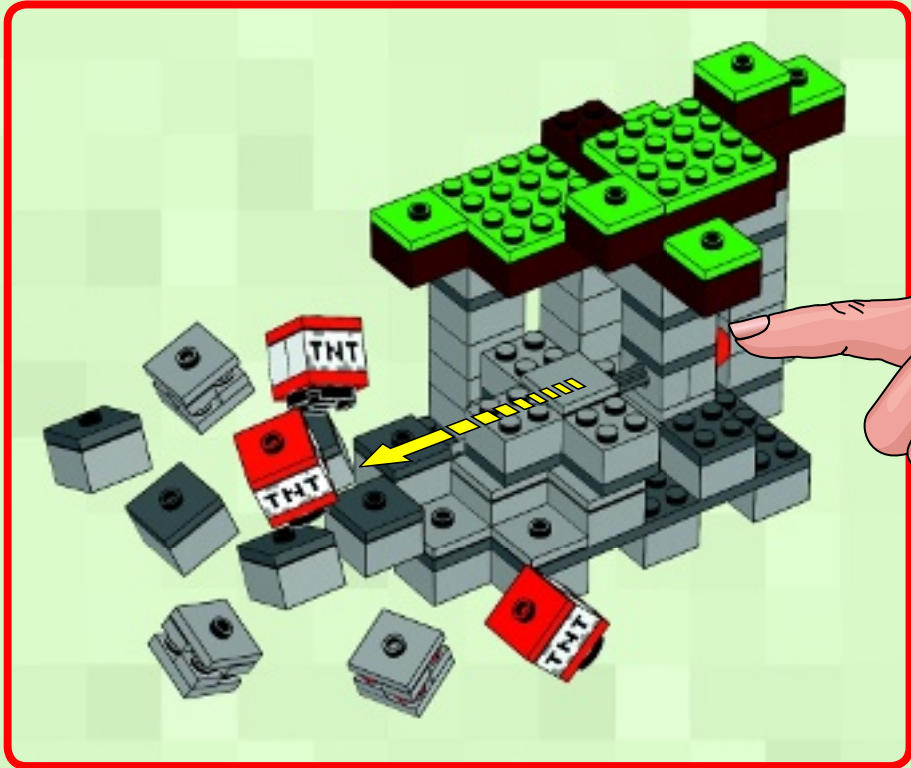
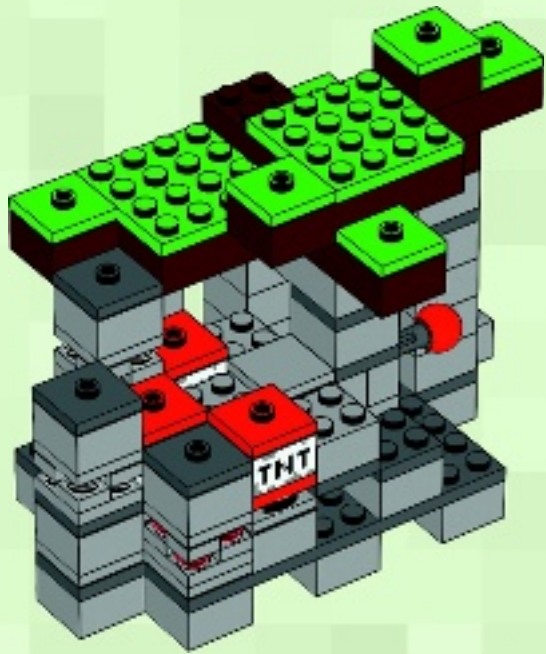



1



2



3

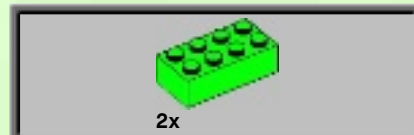

4

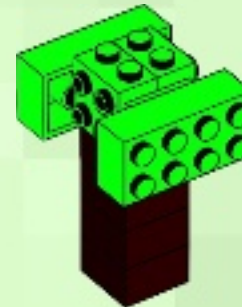



5

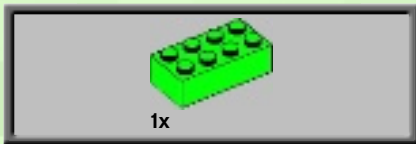
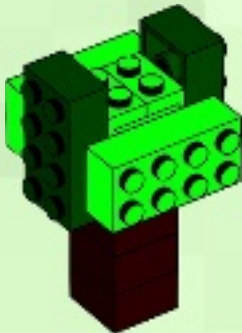

6

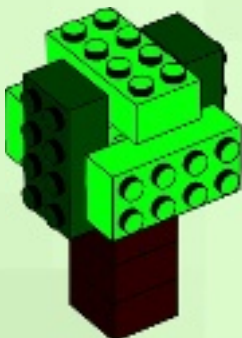

25

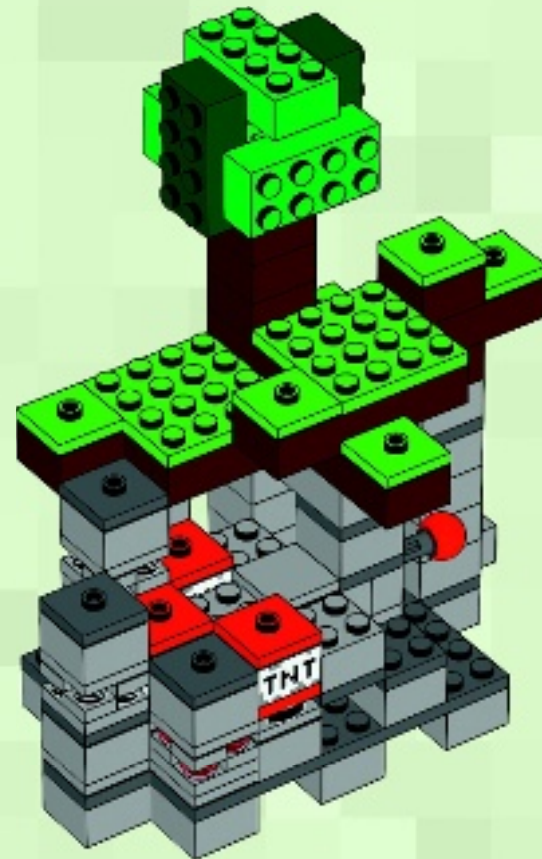

26

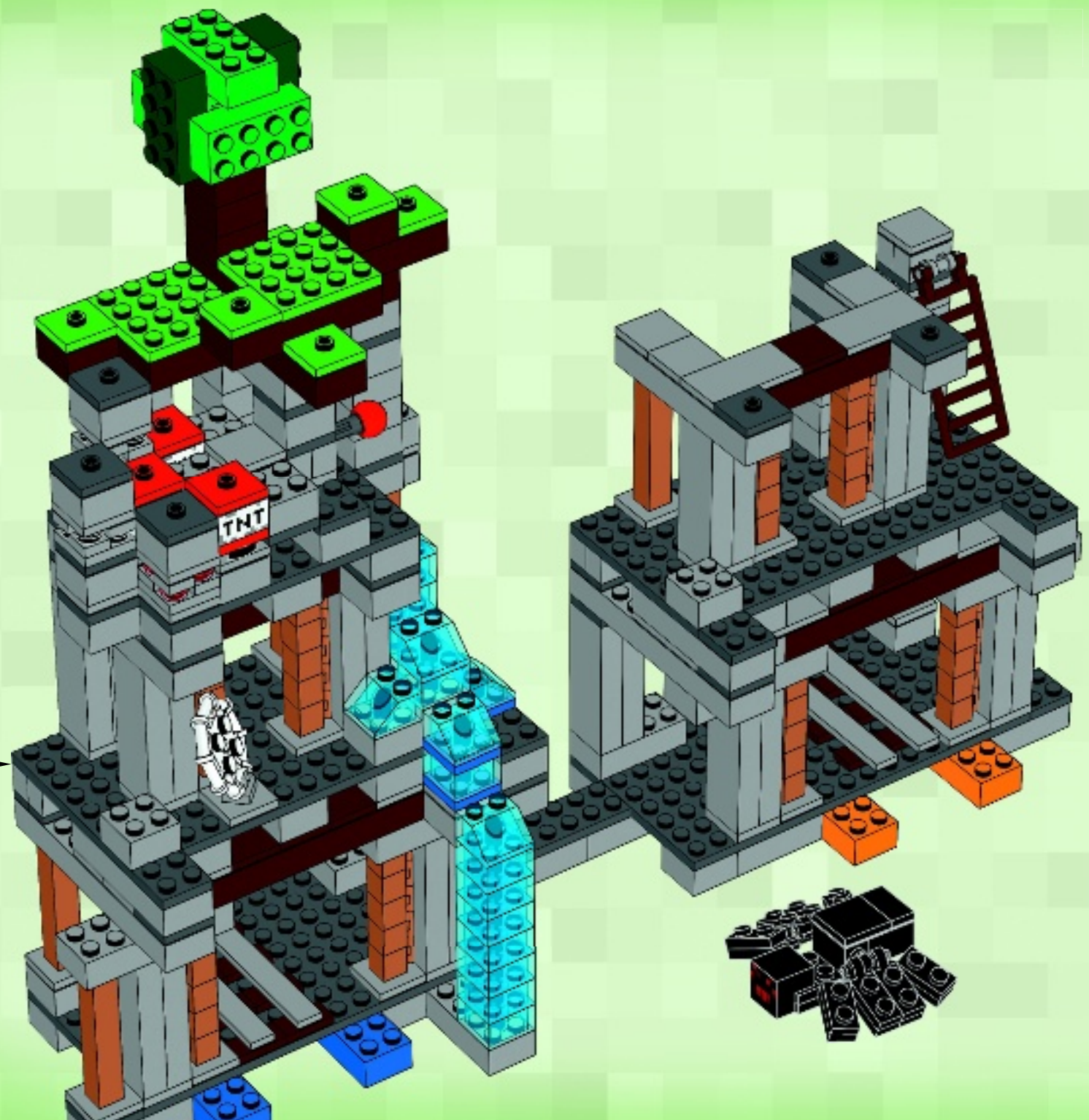

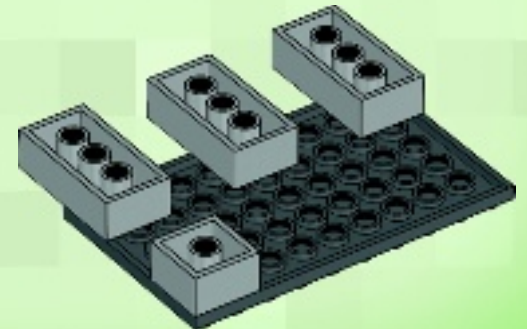
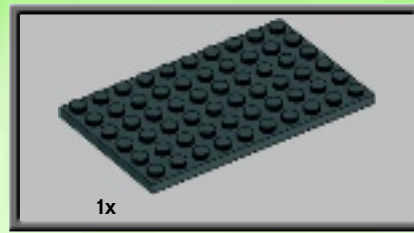
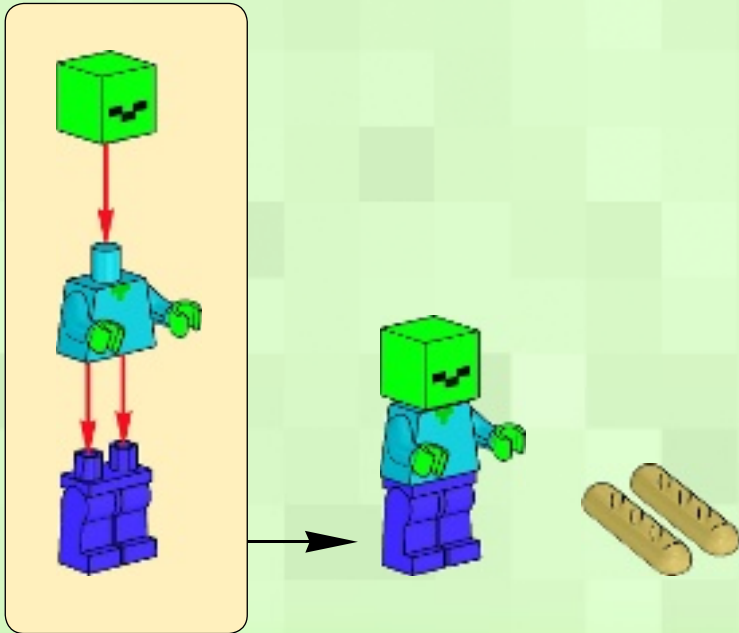
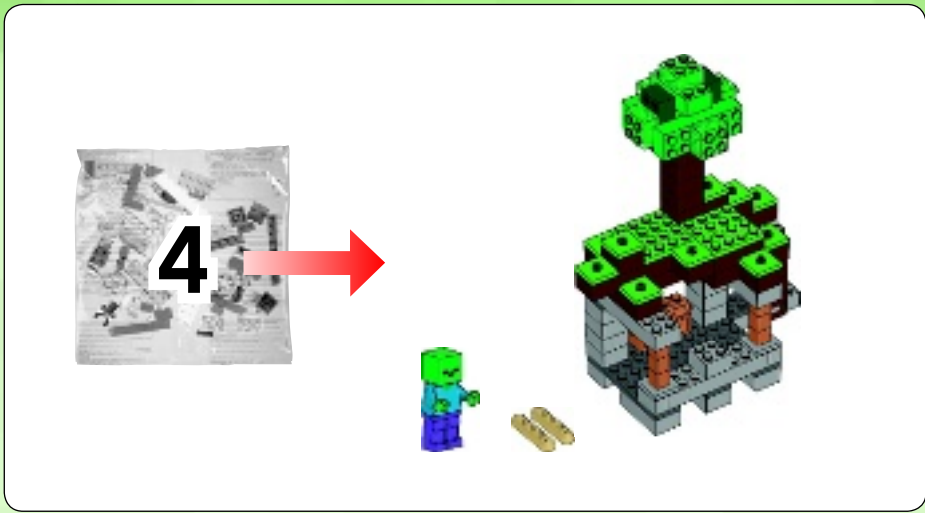



3

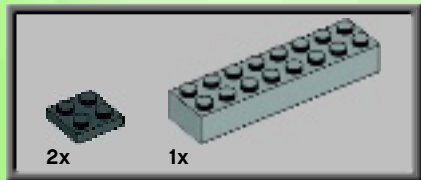
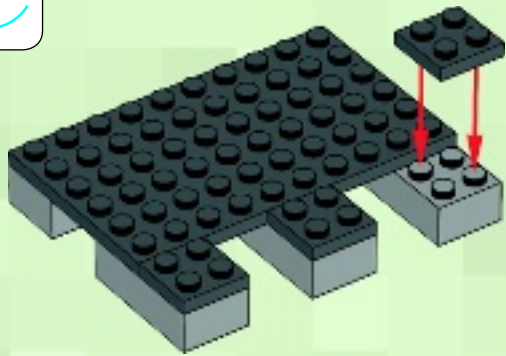

4

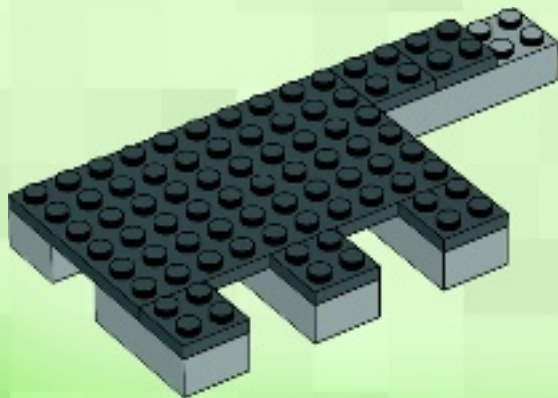
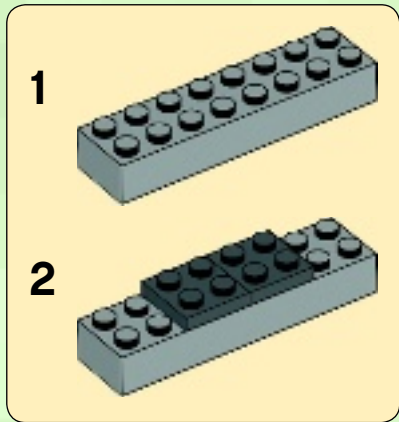

5

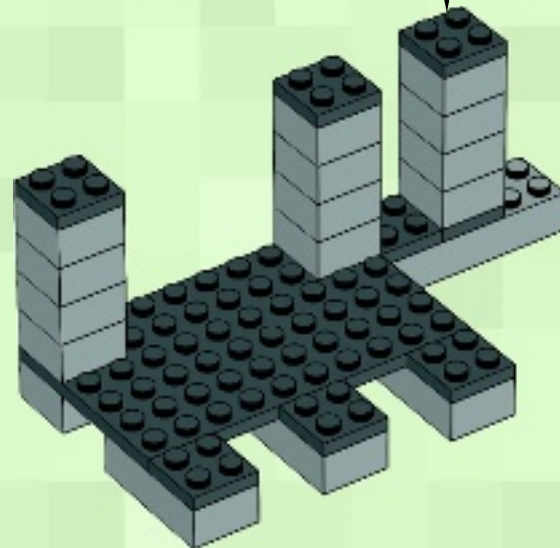
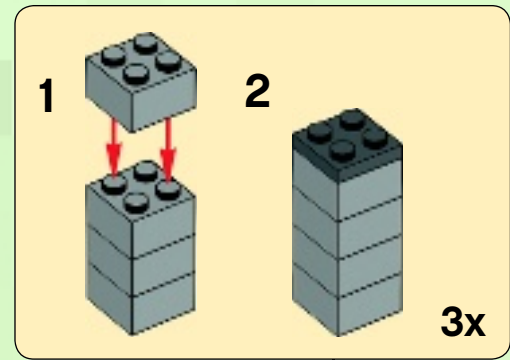

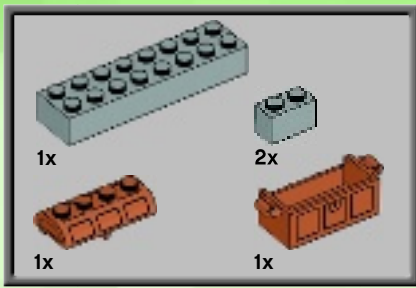

6

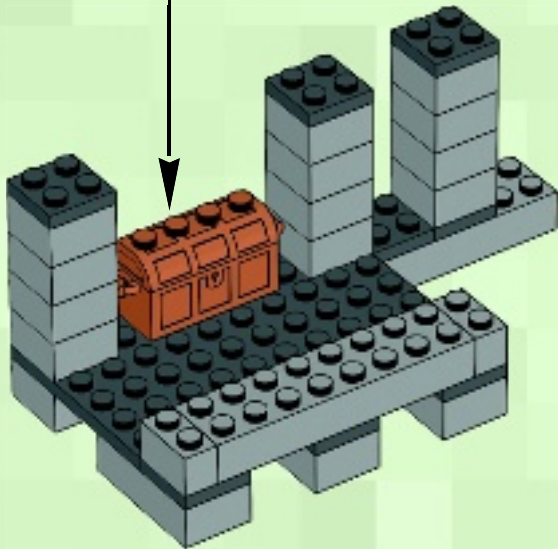
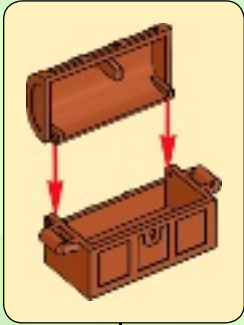

7

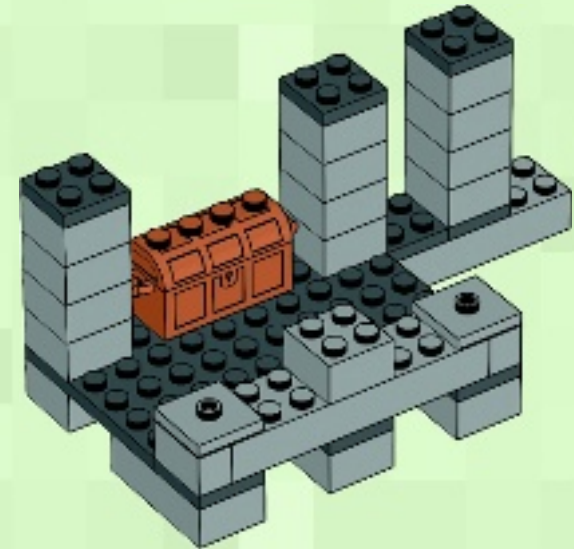



8

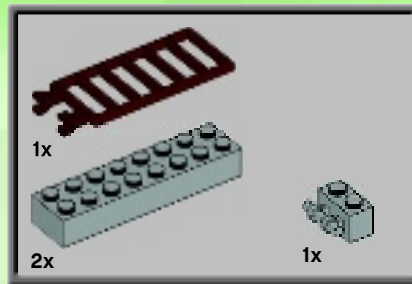
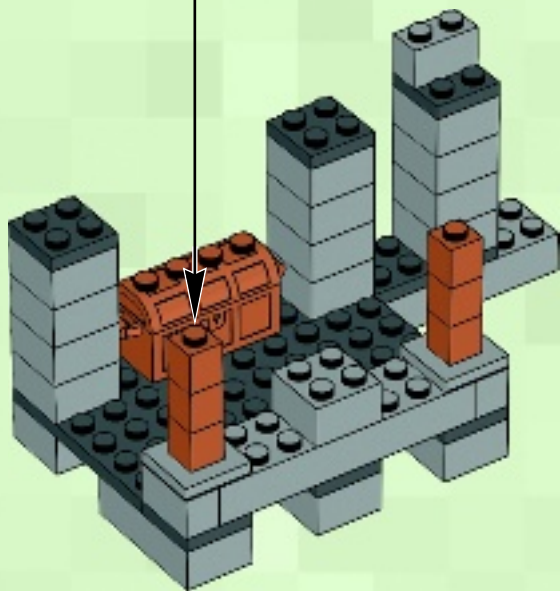
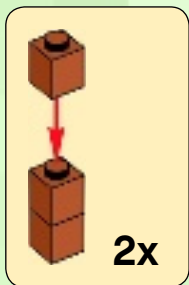

9

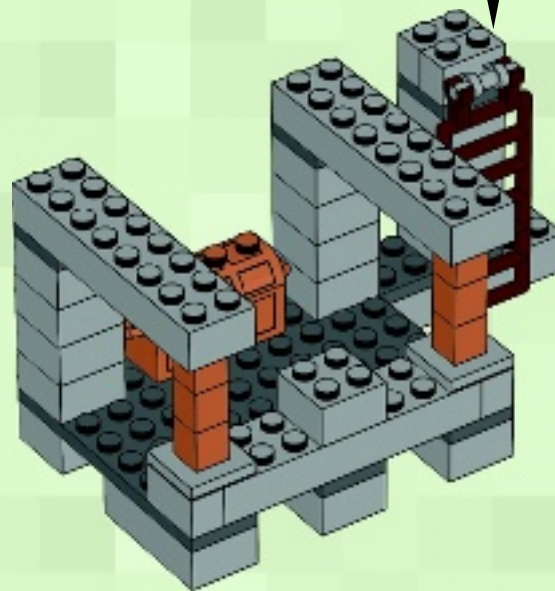
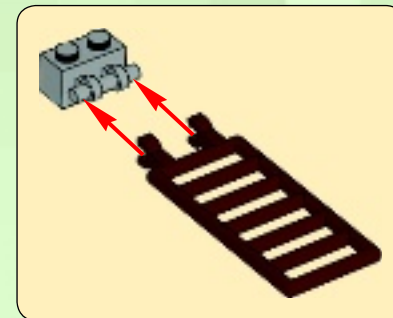

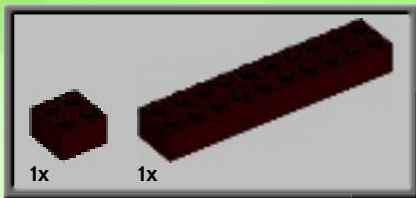

10

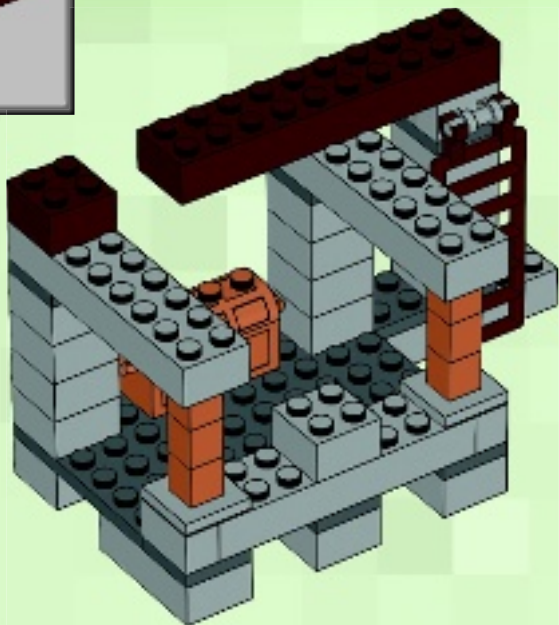

11

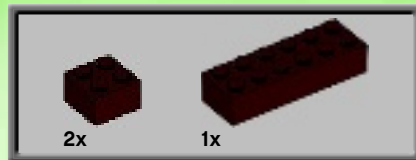
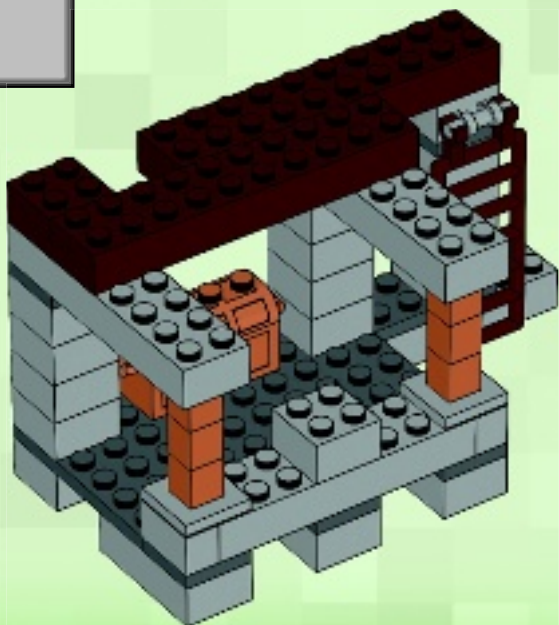

12

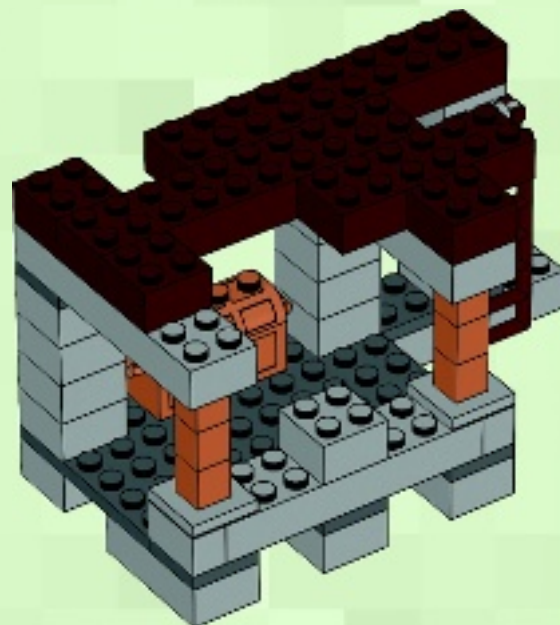

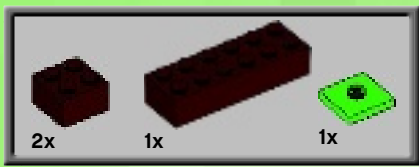

13

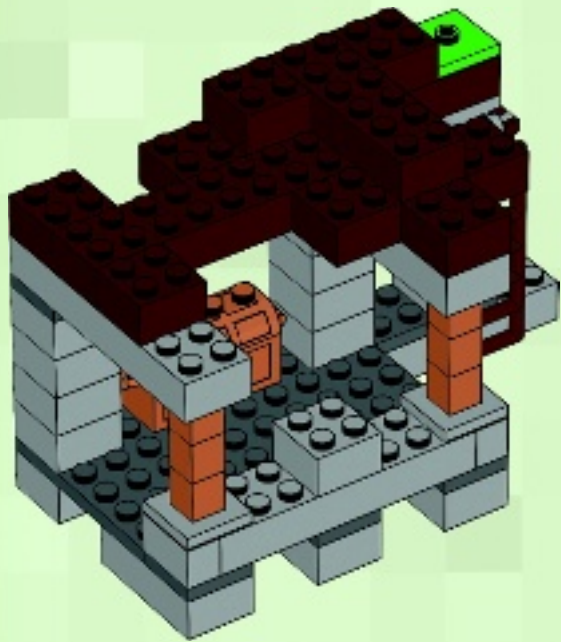

14

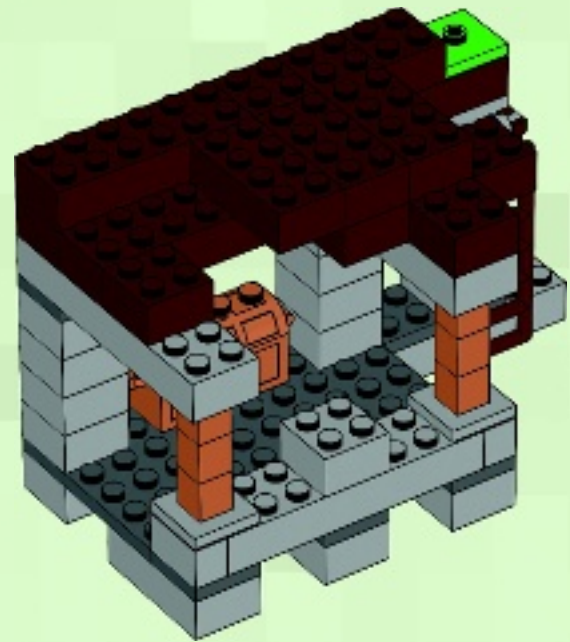



15

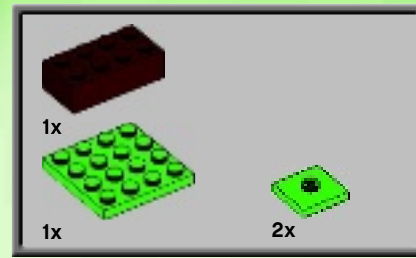
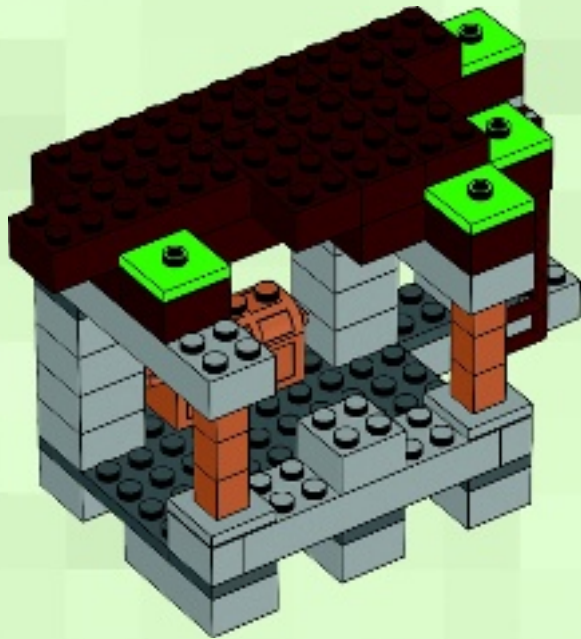

16

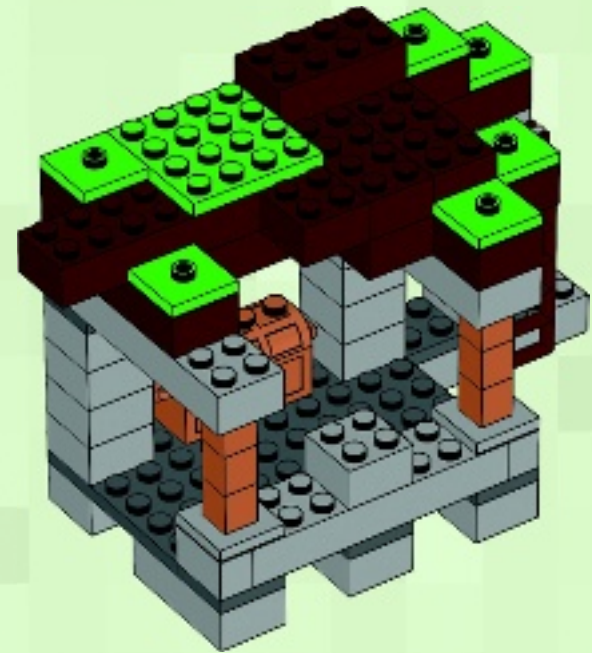



17

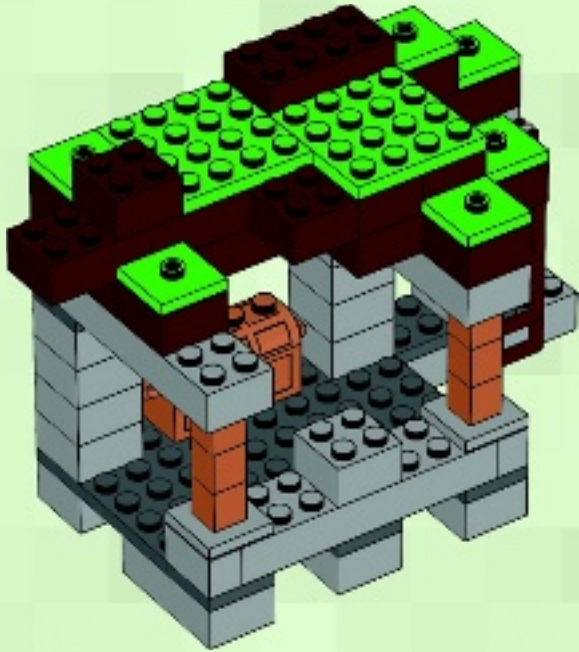

18

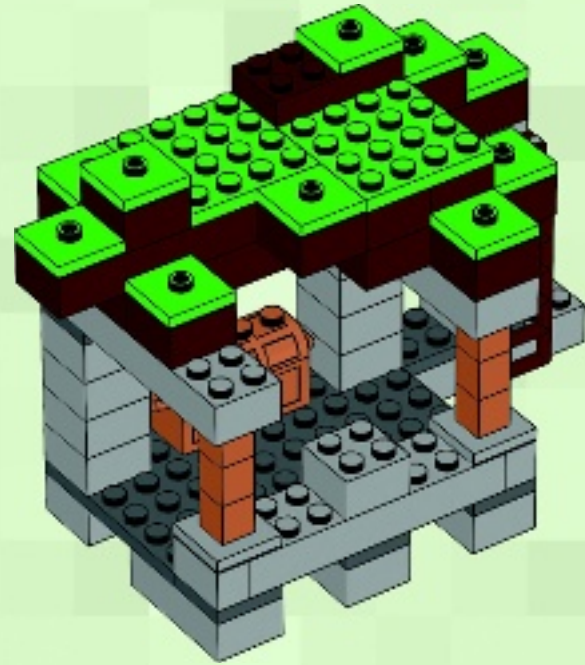



1



2



3

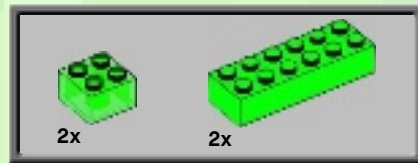

4

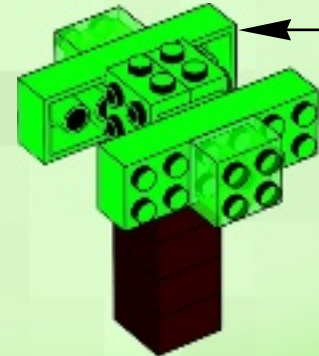
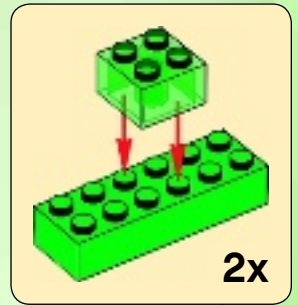



5

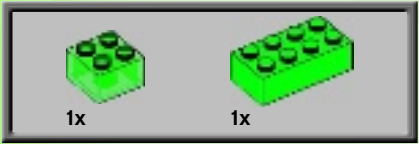
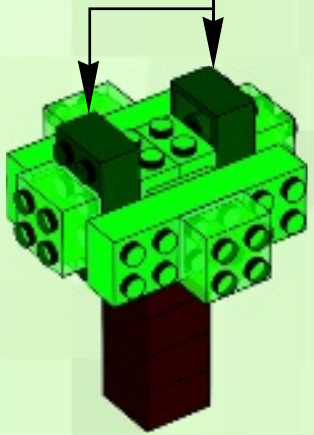
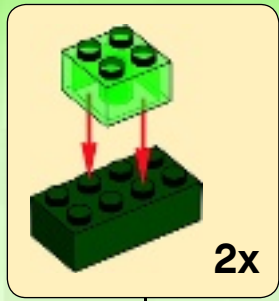

6

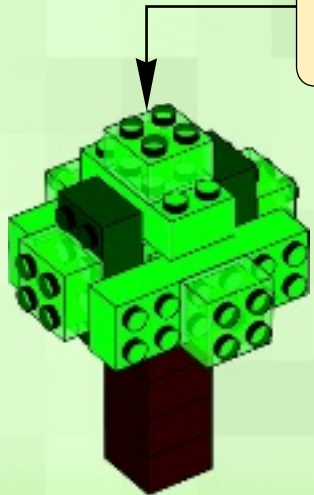
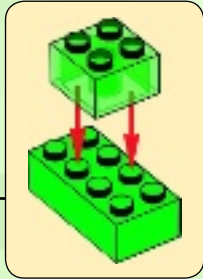

19

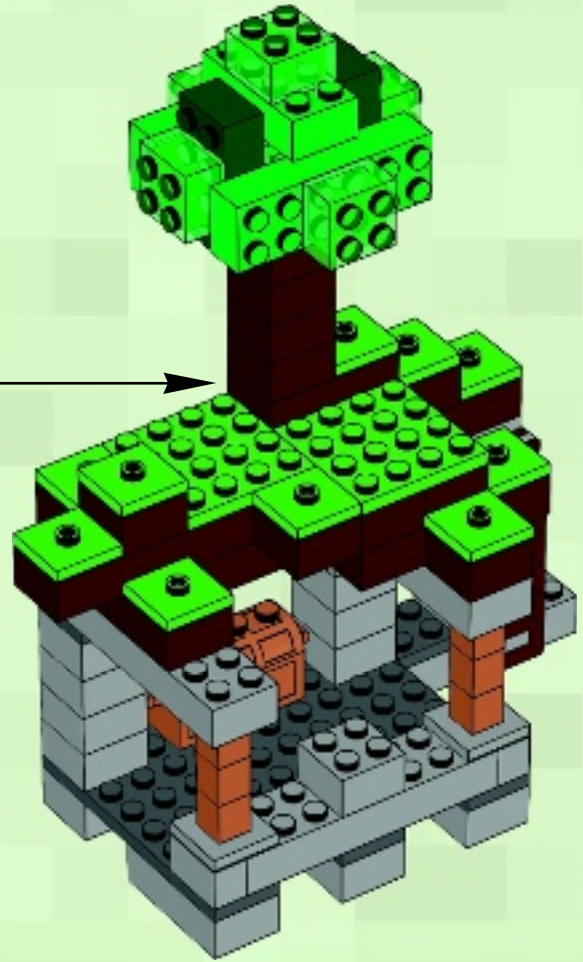

20

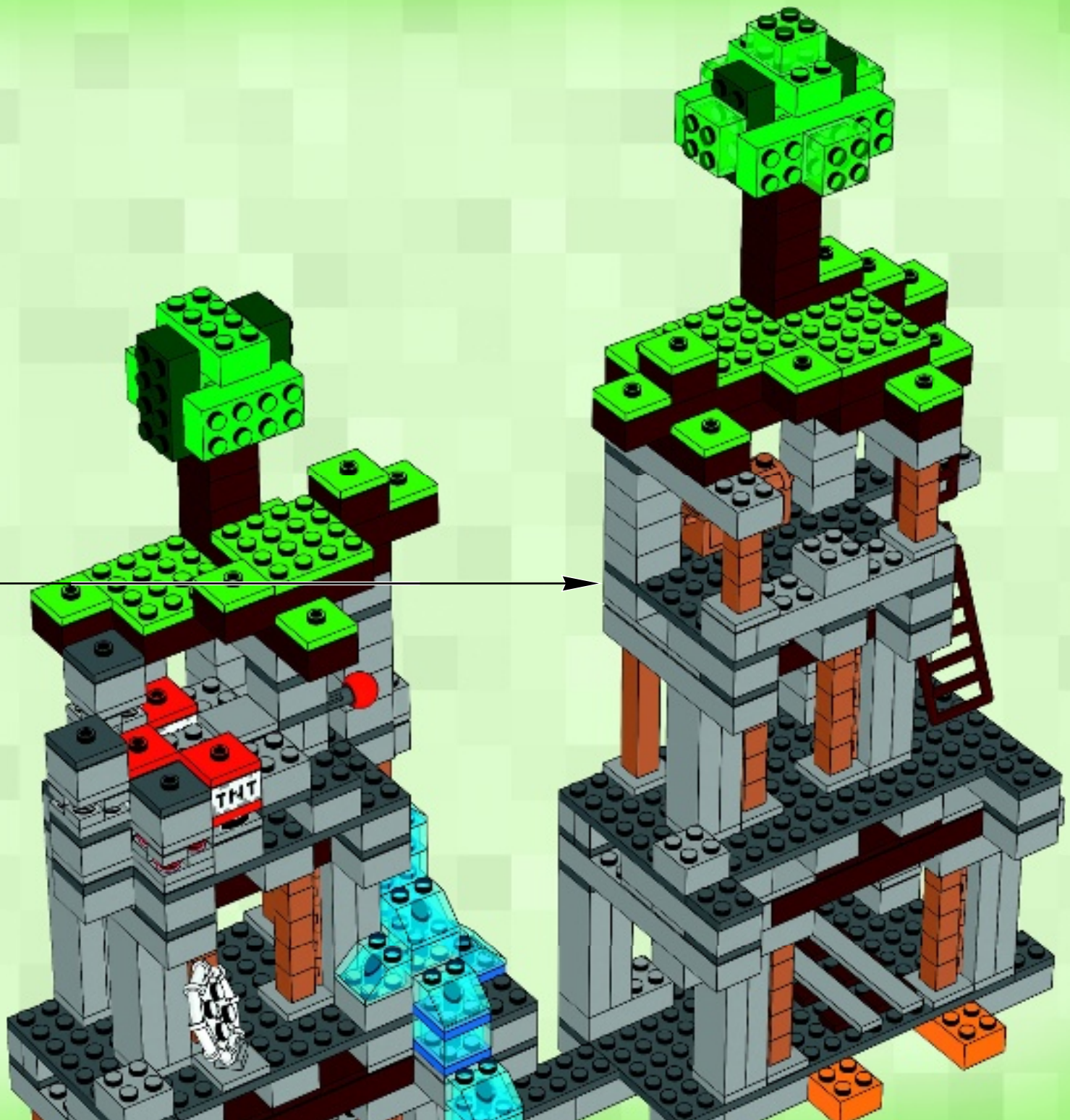

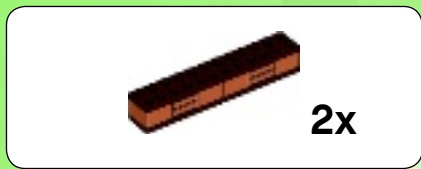

1



2

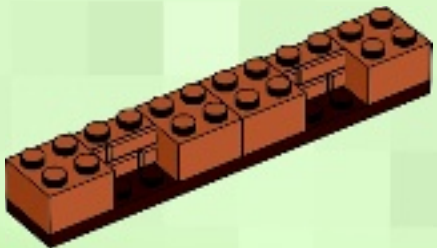

3

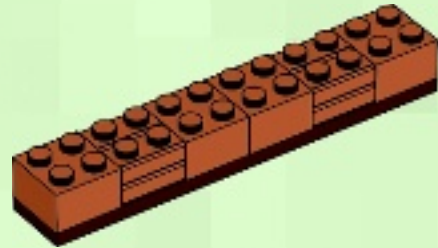

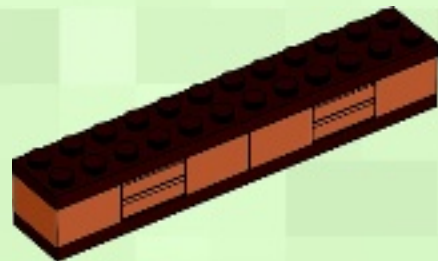

4



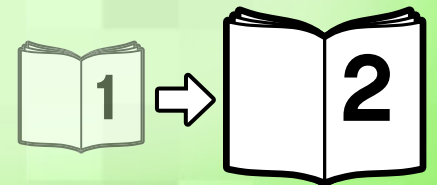
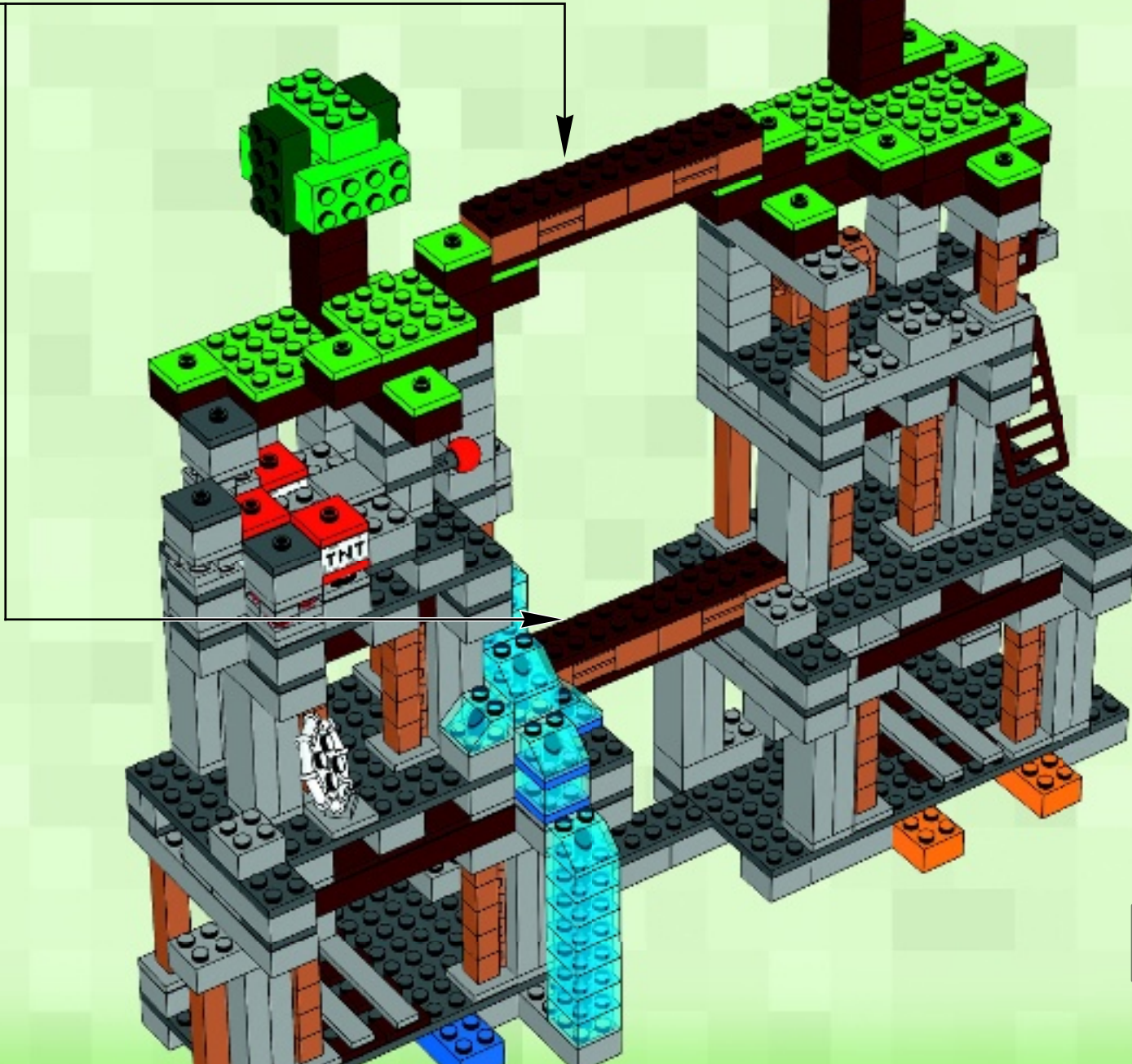

2x

21





 Minecraft is a sandbox construction game, inspired by Infiniminer, Dwarf Fortress and Dungeon Keeper, created by Markus Persson, the founder of Mojang AB. The game involves players creating and destroying various types of blocks in a three dimensional environment. The player takes an avatar that can destroy or create blocks, forming fantastic structures, creations and artwork across the various multi-player servers in multiple game modes.

 Minecraft es un juego de construcción libre creado por Markus Persson, fundador de Mojang AB, e inspirado en Infiniminer, Dwarf Fortress y Dungeon Keeper. A lo largo del juego, los jugadores crean y destruyen diferentes tipos de bloques dentro de un entorno tridimensional. A través de su personaje, cada jugador crea o destruye bloques con objeto de construir fantásticas estructuras, creaciones y obras artísticas en cualquiera de los diferentes servidores multijugador disponibles y los distintos modos que el juego pone a su alcance.

 Minecraft est un jeu de construction « bac à sable » inspiré d'Infiniminer, Dwarf Fortress et Dungeon Keeper, créé par Markus Persson, le fondateur de Mojang AB. Dans ce jeu, les joueurs créent et détruisent divers types de blocs dans un environnement en trois dimensions. Le joueur incarne un avatar qui peut détruire ou créer des blocs, formant ainsi des structures, des créations et des images fantastiques au travers de divers serveurs multi-joueurs et dans des modes de jeu multiples.

 A Minecraft egy sandbox stílusú, azaz szabadon építhető világgal rendelkező számítógépes játék, amelyet Markus Persson a Mojang AB alapítója hívott életre az Infi miner, Dwarf Fortress és Dungeon Keeper nevű játékok alapelgondolására építve. A három dimenziós környezetben a játékosok a számos szerveren és játékmódon keresztül, a maguk által létrehozott karakterrel szabadon formálhatnak meg bármit, az egyszerű alakzatoktól a művészi struktúrákig, a játékot felépítő négyzet alakú tömbök átrendezésével.

 Minecraft é um jogo de construção livre, criado por Markus Persson, o fundador de Mojang AB, e baseia-se nos jogos Infiniminer, Dwarf Fortress e Dungeon Keeper. O jogo envolve jogadores que criam e destroem vários tipos de blocos num ambiente de jogo a três dimensões. O jogador pega num avatar que consiga destruir ou criar blocos, formando estruturas fantásticas, criações e obras de arte através dos vários servidores de multi-jogador em múltiplos modos de jogo.

 Minecraft 是一款沙盒建造游戏，由 Mojang AB 创始人 Markus Persson 受 Dwarf Fortress 和 Dungeon Keeper 两款游戏启发而创建。在这款游戏中，玩家可在三维环境中创造和改变不同类型的方块。玩家可在多游戏模式下多人模式中，选取一个身份改变或创造方块，从而拼装出精美绝伦的结构、作品和艺术品。

 Minecraft ist ein Konstruktionspiel, das von Infiniminer, Dwarf Fortress und Dungeon Keeper inspiriert und von Markus Persson, dem Gründer von Mojang AB, erschaffen wurde. Im Spiel können die Spieler verschiedene Blockarten in einer dreidimensionalen Umgebung erschaffen und zerstören. Der Spieler kann in Form eines Avatars Blöcke zerstören und erschaffen, um so fantastische Gebäude, Kreationen und Kunstwerke auf verschiedenen Mehrspieler-Servern in einer Vielzahl von Spielmodi zu errichten.

MINECRAFT[®]

